

Problem Book
in High-School
Mathematics

Edited by A.I. Prilepko, D.Sc.

Mir Publishers

П. Т. Дыбов
А. И. Забоев
А. С. Иванов
Д. Ф. Калининченко
Н. В. Шолохов

СБОРНИК ЗАДАЧ ПО МАТЕМАТИКЕ

для поступающих в вузы

Под редакцией профессора

А. И. ПРИЛЕПКО

Москва «Высшая школа» 1982

**PROBLEM BOOK
IN HIGH-SCHOOL
MATHEMATICS**

Edited by A. I. PRILEPKO, D.Sc.
Translated from the Russian
by I. A. ALEKSANOVA

MIR Publishers Moscow

First published 1985
Revised from the 1982 Russian edition

На английском языке

© Издательство «Высшая школа», 1982
© English translation, Mir Publishers, 1985

The present problem book is meant for high-school students who intend to enter technical colleges. It contains more than two thousand problems and examples covering all divisions of high-school mathematics.

The main aim of the book is to help students to revise their school knowledge of mathematics and develop a technique in solving a variety of problems.

The book consists of nine chapters divided into sections, each of which deals with a certain theme. The problems on a definite theme are arranged in the order of increasing difficulty, which makes it possible for a student to gradually acquire the necessary techniques and experience in problem solving. Thus, the problems are classified as far as possible. Most of the problems were given at the entrance examinations in various colleges to the USSR in recent years. All the problems are supplied with answers, and some of them with solutions or instructions. The words "Solution" and "Hint" are replaced by the signs \blacktriangle and \bullet respectively. The list of designations makes the use of the book more convenient.

All the contributors to the book have a long experience as lecturers at preparatory courses of colleges, as teachers at high schools specializing in physics and mathematics and as examiners in mathematics.

The authors wish to express their gratitude to the lecturers of the Chair of Higher Mathematics at the Moscow Institute of Physics and Engineering for their help in preparing the manuscript and their useful remarks.

The authors

Contents

	Preface	5	
	List of Designations Accepted in the Book	8	
		Problems	Answers, Hints, Solutions
Chapter 1.	Rational Equations, Inequalities and Functions in One Variable	11	139
1.1.	Linear Equations and Inequalities in One Variable. A Linear Function	11	139
1.2.	Quadratic Equations and Inequalities. A Quadratic Function	14	144
1.3.	Inverse Proportionality	19	150
1.4.	Equations and Inequalities of Higher Degrees. A Rational Function	22	158
1.5.	Linear Systems of Equations and Inequalities	27	168
1.6.	Systems of Equations and Inequalities in Several Higher-Degree Variables	30	171
Chapter 2.	Transcendental Functions, Equations and Inequalities	33	175
2.1.	Irrational Equations and Inequalities	33	175
2.2.	Systems of Irrational Equations and Inequalities	38	180
2.3.	An Exponential and a Logarithmic Function, Exponential and Logarithmic Equations, Systems of Equations, and Inequalities	39	181
2.4.	Transformation of Trigonometric Expressions	51	191
2.5.	Trigonometric Functions	54	193
2.6.	Inverse Trigonometric Functions	57	200
2.7.	Trigonometric Equations and Systems of Equations	61	205
2.8.	Trigonometric Inequalities	70	219
Chapter 3.	Problems on Deriving Equations and Inequalities	72	221
3.1.	Problems on Motion	72	221
3.2.	Problems on Percentages, Mixtures, Numbers and Work	78	222

	Problems	Answers, Hints, Solutions
3.3. Problems on Deriving Inequalities and Systems of Inequalities. Problems on the Extremum	83	223
Chapter 4. The Antiderivative and the Integral	86	225
4.1. The Antiderivative. The Newton-Leibniz Formula	86	225
4.2. Calculating the Areas of Plane Figures	89	227
Chapter 5. Progressions and Number Sequences	92	230
5.1. Progressions	92	230
5.2. Number Sequences	98	233
Chapter 6. Elements of Vector Algebra	101	236
6.1. Linear Operations on Vectors	101	236
6.2. The Scalar Product of Vectors	103	237
Chapter 7. Plane Geometry	107	241
7.1. Problems on Proving Propositions	107	241
7.2. Construction Problems	109	245
7.3. Problems on Calculation	110	247
Chapter 8. Solid Geometry	115	252
8.1. A Straight Line, a Plane. Polyhedra. Solids of Revolution	115	252
8.2. Problems on Combinations of Polyhedra and Solids of Revolution	120	257
8.3. Volumes of Solids of Revolution	127	264
Chapter 9. Miscellaneous Problems	128	265
9.1. Problems in Algebra	128	265
9.2. Limit of a Function. Continuity	131	270
9.3. The Derivative of a Function	132	273
9.4. Integral Calculus. Miscellaneous Problems	134	275

List of Designations Accepted in the Book

- \mathbb{N} , the set of all natural numbers
 \mathbb{Z}_0 , the set of all nonnegative integers
 \mathbb{Z} , the set of all integers
 \mathbb{Q} , the set of all rational numbers
 \mathbb{R} , the set of all real numbers
 $[a; b]$, a closed interval from a to b , $a < b$
 $(a; b)$, an open interval from a to b , $a < b$
 $(a; b]$, $[a; b)$, semi-open intervals from a to b , $a < b$
 $(a; \infty)$, $[a; \infty)$, $(-\infty; b]$, $(-\infty; b)$, infinite intervals, rays
of a number line
 $(-\infty; \infty)$, an infinite interval, a number line
 \Rightarrow , sign of implication
 \Leftrightarrow , sign of equivalence
 \in , sign of membership relation
 $n \in \mathbb{N}$, the number n belongs to the set of natural numbers
 \subset , sign of inclusion
 $C \subset D$, the set C is included into the set D , or C is a sub-
set of D
 \cup , sign of union
 $C \cup D$, union of the sets C and D
 $(a - \varepsilon; a + \varepsilon) - \varepsilon$, the neighbourhood of the point a
 $\{a; b; \dots\}$, a set consisting of the elements a, b, \dots
 $(a; b)$, an ordered pair
 $(a; b; c)$, an ordered triple
 $n!$, an n -factorial, the product of the first n natural numbers
($1! = 1$)
 $[x]$, the integral part of the number x
 $\{x\}$, the fractional part of the number x
 $|x|$, the modulus (absolute value) of the number x
 (x_n) , (a_n) , an infinite number sequence

$\lim_{n \rightarrow \infty} x_n = a$, the number a is the limit of the sequence (x_n)
 $f(x)$, the value of the function f at the point x
 $D(f)$, the domain of definition of the function f
 $E(f)$, the range of the function f
 Δx , an increment of the variable x
 $\Delta f(x_0)$, Δf , an increment of the function f at the point x_0
 $\lim_{x \rightarrow a} f(x) = b$, the number b is a limit of the function f as x tends to a
 $f'(x_0)$, the derivative of the function f at the point x_0
 \log , decimal logarithm
 \ln , natural logarithm (logarithm to the base e)
 $\max f$, the greatest value of the function f on the interval $[a; b]$
 $\min f$, the least value of the function f on the interval $[a; b]$
 $\int f(x) dx$, the general form of the antiderivatives of the function $f(x)$
 $\int_a^b f(x) dx$, the integral of the function f in the limits from a to b
 $A \in \Phi$, the point A belongs to the figure Φ
 $A \notin \Phi$, the point A does not belong to the figure Φ
 $\Phi_1 \cap \Phi_2$, the intersection of the figures Φ_1 and Φ_2
 \emptyset , an empty set
 $\Phi_1 \cong \Phi_2$, the figures Φ_1 and Φ_2 are congruent (equal)
 $\Phi_1 \sim \Phi_2$, the figures Φ_1 and Φ_2 are similar
 $\uparrow\uparrow$ ($\downarrow\downarrow$), similarly (oppositely) directed
 \parallel , parallel
 \perp , perpendicular
 \sphericalangle , an angle, a dihedral angle, a trihedral angle
 \sphericalangle , the magnitude (degree, measure) of the angle
 $\widehat{(a, b)}$, the magnitude of the angle between straight lines
 $\widehat{(a, \alpha)}$, the magnitude of the angle between a line and a plane
 $\widehat{(\alpha, \beta)}$, the magnitude of the angle between planes
 (AB) , a straight line AB
 $[AB]$, a segment AB

\overrightarrow{AB} , a ray AB
 $|AB|$, the length of the segment AB
 \mathbf{a} , \overrightarrow{AB} , a vector
 $\mathbf{0}$, \overrightarrow{AA} , a zero vector
 $\widehat{(\mathbf{a}, \mathbf{b})}$, the magnitude of the angle between two vectors
 $|\mathbf{a}| = a$, $|\overrightarrow{AB}| = |AB|$, the length of a vector
 $(\mathbf{i}, \mathbf{j}, \mathbf{k})$ an orthogonal basis
 $\mathbf{a} = (x, y, z)$, a vector with coordinates x, y, z
 $\mathbf{a} \cdot \mathbf{b}$, $\overrightarrow{AB} \cdot \overrightarrow{CD}$, a scalar product of vectors

Chapter 1

RATIONAL EQUATIONS, INEQUALITIES AND FUNCTIONS IN ONE VARIABLE

1.1. Linear Equations and Inequalities in One Variable. A Linear Function

Solve the following equations:

- $(3x + 7) - (2x + 5) = 3.$
- $\frac{x}{2} + \frac{x}{6} + \frac{x}{12} + \frac{x}{20} + \frac{x}{30} + \frac{x}{42} = -6.$
- (a) $3x + 1 = (4x - 3) - (x - 4);$
(b) $3x + 1 = (4x - 3) - (x - 5).$
- $ax = a^2.$ 5. $(a - 2)x = a^2 - 4.$
- $(a^2 - 9)x = a^3 + 27.$

Solve the following inequalities:

- (a) $7x > 3;$ (b) $-4x > 5;$ (c) $5x + 6 \leq 3x - 8;$
(d) $x/2 + 1 \leq x/\sqrt{3} + 1/2.$
- (a) $ax \leq 1;$ (b) $ax > 1.$

Solve the following systems of inequalities:

- (a) $\begin{cases} 3x > 1, \\ -x < 3; \end{cases}$ (b) $\begin{cases} 2x < \pi, \\ -x > -1.6; \end{cases}$
(c) $\begin{cases} x > -1, \\ 2x + 1 \leq 5; \end{cases}$ (b) $\begin{cases} 3x + 2 \geq 0, \\ x + \sqrt{5} < 0. \end{cases}$
- Find all the values of $x \in N$ satisfying the inequality $5x - 7 < 2x + 8.$

Solve the following equations:

- (a) $|x - 1| = 3;$ (b) $|x + 2| = -1.$
- (a) $|3 - x| = a;$ (b) $|x - a| = 2.$
- (a) $|x - 3| = x - 3;$ (b) $|x - 3| = 3 - x;$
(c) $|x - 3| = x.$
- $|2x - 1| = |x + 3|.$
- $|x - a| = |x - 4|.$

16. (a) $|x - 4| + |x + 4| = 9$; (b) $|x - 4| + |x + 4| = 8$; (c) $|x - 4| - |x + 4| = 8$; (d) $|x + 4| - |x - 4| = 8$.
17. $|x - 3| + |x + 2| - |x - 4| = 3$.
18. At what values of a does the equation $|2x + 3| + |2x - 3| = ax + 6$ possess more than two roots?

Solve the following equations:

19. (a) $|x| > a$; (b) $|x - 1| > -1$; (c) $|x - 1| > 1$.
20. (a) $|x| < a$; (b) $|x + 2| \leq -2$; (c) $|x + 2| < 2$.
21. (a) $|2x + 1| > x$; (b) $|2x + 3| \leq 4x$.
22. $|1 - 3x| - |x + 2| \leq 2$.
23. $|x + 2| + |x - 3| > 5$.

Solve the following inequalities:

24. $\begin{cases} |x| \geq x, \\ 2x - 1 > 3. \end{cases}$ 25. $\begin{cases} |x| \leq -x, \\ |x + 2| > 1. \end{cases}$
26. At what value of a is the function $f(x) = (a - 2)x + 3a - 4$, $x \in (-\infty; +\infty)$ (a) even; (b) odd?
27. At what value of a is the function $f(x) = (a + 3)x + 5a$, $x \in (-\infty; \infty)$ periodic?
28. Find the values of k for which the function $f(x) = (k - 1)x + k^2 - 3$, $x \in (-\infty; \infty)$ (a) increases monotonically; (b) decreases monotonically.
29. Determine the values of m for which the function $y = (m^2 - 4)x + |m|$, $x \in (-\infty; \infty)$ has an inverse. Find the inverse function.
30. Given the linear function $f(x)$. Prove that the function $F(x) = f(f(x))$ is also linear.

Construct the graphs of the following functions:

31. (a) $y = 2x$, (b) $y = -\frac{1}{3}x$.
32. (a) $y = x - 2$; (b) $y = 3 - x$.
33. (a) $y = 2x - 1$; (b) $y = 1 - 3x$.
34. (a) $y = |x - 1|$; (b) $y = -|x + 2|$.
35. (a) $y = |1 + 2x|$; (b) $y = -|-4x + 2|$.
36. $y = ||x - 1| - 2|$. 37. $y = |x + 2| + |x - 3|$.

38. $y = |2x + 1| - |2x - 2|$. 39. $y = x + x/|x|$.

40. $y = x + |x - 1| + \frac{|x - 2|}{x - 2}$.

Construct the graphs of the following functions:

41. $\frac{y}{x+1} = -1$. 42. $|y| + x = -1$.

43. $|x| + |y| = 2$. 44. $|y - 3| = |x - 1|$.

Indicate the points on the plane xOy which satisfy the following inequalities:

45. $y > x$. 46. $y < -x$.

47. $y \geq |x|$. 48. $x > |y|$.

Indicate the points on the plane xOy which satisfy the following equations:

49. $y + |y| - x - |x| = 0$.

50. $|x + y| + |x - y| = 4$.

51. $|y|x = x$. 52. $|x - y| + y = 0$.

53. Find the value of a for which the function y is continuous at the point $x = 0$, if

$$y = \begin{cases} 2x + 1 & \text{for } x \leq 0, \\ -x + a & \text{for } x > 0. \end{cases}$$

54. Find the critical points of the function (a) $y = |3x + 1|$; (b) $y = |x + 1| + x + 1$; (c) $y = |x + 1| + |x - 1|$; (d) $y = |x - 3| - |x + 3|$.

Find the intervals of the monotonic increase and decrease of the following functions:

55. (a) $y = 3 - x$; (b) $y = \frac{1}{4}x + 1$.

56. (a) $y = 2 + |x - 4|$; (b) $y = 3 - |x|$.

57. (a) $y = -(|x + 10| + |x - 10|)$; (b) $y = |x - 4| - |x + 5|$; (c) $y = |x + 4| - |x + 3| + |x + 2| - |x + 1| + |x|$.

Find the points of extremum of the following functions:

58. (a) $y = |2x - 1|$; (b) $y = 2 - |3 - 4x|$.

59. (a) $y = |3x + 2| + |2x - 3|$; (b) $y = |x + 7| - 2|x - 2|$.

60. $y = 2|x - 1| - 3|x + 2| + x$.
 61. $y = |x - 2| + |x - a|$.
 62. Find the values of a for which the function y possesses a maximum at the point $x = 2$, if

$$y = \begin{cases} x + 1 & \text{for } x < 2, \\ a & \text{for } x = 2, \\ 5 - x & \text{for } x > 2. \end{cases}$$

63. Find the least and the greatest value of the function $y = |x - a|$ on the interval $[1; 2]$ ($a \neq 1$; $a \neq 2$).

1.2. Quadratic Equations and Inequalities. A Quadratic Function

Solve the following equations and inequalities:

- (a) $x^2 - 7x + 12 = 0$; (b) $-x^2 + 4x + 5 = 0$;
 (c) $6x^2 - 5x + 1 = 0$; (d) $3x^2 + 10x + 3 = 0$;
 (e) $x^2 - 2x - 5 = 0$; (f) $2x^2 + x - 8 = 0$.
- (a) $x^2 - 3x - 4 > 0$; (b) $x^2 - 3x - 4 \leq 0$;
 (c) $x^2 + 4x + 4 > 0$; (d) $4x^2 + 4x + 1 \leq 0$;
 (e) $2x^2 - x + 5 > 0$; (f) $x^2 - x + 1 < 0$.
- Find solutions to the following systems:
 - $\begin{cases} 2x^2 - 5x + 2 = 0, \\ x - 2 < 0; \end{cases}$ (b) $\begin{cases} x^2 - 2x - 3 = 0, \\ x + 4 \geq 0; \end{cases}$
 - $\begin{cases} x^2 - 9 \geq 0, \\ x - 4 < 0; \end{cases}$ (d) $\begin{cases} x^2 - 6x + 5 \geq 0, \\ x^2 - 25 \leq 0; \end{cases}$
 - $\begin{cases} x^2 + 6x + 9 \leq 0, \\ 2x - 5 > 0; \end{cases}$ (f) $\begin{cases} x^2 + x + 8 < 0, \\ x^2 + 6x + 5 = 0; \end{cases}$
 - $\begin{cases} |x - 2| + |x - 3| = 1, \\ 813x - 974 \leq 163x^2. \end{cases}$
- Suppose x_1 and x_2 are roots of the equation $x^2 + x - 7 = 0$. Find (a) $x_1^2 + x_2^2$; (b) $x_1^3 + x_2^3$; (c) $x_1^4 + x_2^4$ without solving the equation.
- Given the equation $ax^2 + bx + c = 0$. Prove that if x_1, x_2 and x_3 are pairwise distinct real roots of this equation, then $a = b = c = 0$.

6. At what values of a does the equation $(a^2 - 3a + 2)x^2 - (a^2 - 5a + 4)x + a - a^2 = 0$ possess more than two roots?
7. The equation $x^2 + px + q = 0$, where $p \in \mathbb{Z}$, $q \in \mathbb{Z}$, has rational roots. Prove that those roots are integers.
8. Prove that the equation $x^2 + (2m + 1)x + 2n + 1 = 0$ does not possess any rational roots if $m \in \mathbb{Z}$, $n \in \mathbb{Z}$.
9. At what values of a does the equation $2x^2 - (a^3 + 8a - 1)x + a^2 - 4a = 0$ possess roots of opposite signs?
10. Find all the values of a for which the equation $x^2 - ax + 1 = 0$ does not possess any real roots.
11. At what values of k does the equation $x^2 + 2(k - 1)x + k + 5 = 0$ possess at least one positive root?
12. Find all the values of m for which both roots of the equation $2x^2 + mx + m^2 - 5 = 0$ (a) are less than 1; (b) exceed -1 .
13. Find all the values of k for which one root of the equation $x^2 - (k + 1)x + k^2 + k - 8 = 0$ exceeds 2 and the other root is smaller than 2.
14. Suppose x_1 and x_2 are roots of the equation $x^2 + 2(k - 3)x + 9 = 0$ ($x_1 \neq x_2$). At what values of k do the inequalities $-6 < x_1 < 1$ and $-6 < x_2 < 1$ hold true?
15. Find all the values of k for which one root of the equation $(k - 5)x^2 - 2kx + k - 4 = 0$ is smaller than 1 and the other root exceeds 2.
16. At what values of m is the inequality $mx^2 - 9mx + 5m + 1 > 0$ satisfied for any $x \in \mathbb{R}$?
17. Find all the values of m for which every solution of the inequality $1 \leq x \leq 2$ is a solution of the inequality $x^2 - mx + 1 < 0$.

Solve the following equations:

18. (a) $x^2 - |x| - 2 = 0$; (b) $x^2 + 5|x| + 4 = 0$.
19. (a) $2x^2 - |5x - 2| = 0$; (b) $x^2 - |x - 1| = 0$.
20. (a) $|x^2 + x - 6| = x^2 + x - 6$; (b) $|6x^2 - 5x + 1| = 5x - 6x^2 - 1$; (c) $|x^2 + x| = x^2 + x$; (d) $|x^2 - x + 5| = x - x^2 - 5$.
21. (a) $|x^2 - 1| = x + 3$; (b) $|x^2 - 1| = |x + 3|$.

22. (a) $|2x^2 - 1| = x^2 - 2x - 3$;
 (b) $|2x^2 - 1| = |x^2 - 2x - 3|$.

23. $|x^2 - 3|x| + 2| = x^2 - 2x$.

Solve the following inequalities:

24. (a) $x^2 - |x| - 12 < 0$; (b) $x^2 + 2|x| - 15 \geq 0$;
 (c) $x^2 - 7|x| + 10 \leq 0$; (d) $8x^2 + |-x| + 1 > 0$;
 (e) $4x^2 + 2|x| + 0.25 < 0$.

25. (a) $3x^2 - |10x - 3| > 0$; (b) $x^2 \leq |x - 2|$.

26. (a) $|x^2 + x - 20| \leq x^2 + x - 20$; (b) $|x - 2x^2| > 2x^2 - x$;
 (c) $|x^2 + 6x + 8| \leq -x^2 - 6x - 8$.

27. (a) $|x^2 - 6| > 4x + 1$; (b) $|x - 3| > |x^2 - 3|$.

28. (a) $|2x^2 - x - 10| > |x^2 - 8x - 22|$;
 (b) $|x^2 - 5|x| + 4| \geq |2x^2 - 3|x| + 1|$.

29. Find the domain of definition of the function (a) $y = \sqrt{-x^2}$;
 (b) $y = x - \sqrt{1 - x^2}$;
 (c) $y = \sqrt{x^2 - 4x + 3}$;
 (d) $y = 1/\sqrt{x^2 + 4x}$;
 (e) $y = \sqrt{16 - x^2} + \sqrt{x^2 + x}$;
 (f) $y = \sqrt{x^2 - |x|} + 1/\sqrt{9 - x^2}$.

30. Prove that the function $f(x) = ax^2 + bx + c$, $a \neq 0$, is not periodic.

31. At what values of a does the function $f(x) = -x^2 + (a - 1)x + 2$ increase monotonically on the interval $(1; 2)$?

32. Find the inverse of the function $f(x) = x^2 - 6x + 1$
 (a) on the interval $(-\infty; 3)$; (b) on the interval $(5; 7)$.

Construct the graphs of the following functions:

33. (a) $y = x^2$; (b) $y = (x - 2)^2$;
 (c) $y = 2(x - 2)^2$; (d) $y = 2(x - 2)^2 - 1$.

34. (a) $y = -x^2$; (b) $y = -(x + 1)^2$;
 (c) $y = -0.5(x + 1)^2$; (d) $y = 2 - 0.5(x + 1)^2$.

35. (a) $y = x^2 + 5x + 6$; (b) $y = 4x^2 + 4x + 1$;
 (c) $y = x^2 + x + 1$.

36. (a) $y = 3x - x^2 - 2$; (b) $y = 2x - x^2 - 1$;
 (c) $y = x - x^2 - 1$.

37. (a) $y = x^2 - 4|x| + 3$; (b) $y = x^2 + 4|x| + 3$;
 (c) $y = 2 - |x| - x^2$.

38. (a) $y = |x^2 + x|$; (b) $y = -|x^2 - 2x|$.

39. (a) $y = |x^2 - 3| |x| + 2|$; (b) $y = -|x^2 - |x| - 6|$.
40. (a) $y = |x| (x - 2)$; (b) $y = (3 - x) |x + 1|$.
41. $y = |x^2 - 4| - |x^2 - 9|$.
42. Find the derivative of the function (a) $y = x^2 - 6x + 15$; (b) $y = -x^2 - x + \sqrt{5}$; (c) $y = 3x^2 + x + \sin 1$; (d) $y = -4x^2 - (\tan 2)x + \pi$;
 (e) $y = \frac{1}{2}x^2 - x\sqrt{3} + 2\sqrt{2}$; (f) $y = -\frac{1}{3}x^2 + \pi x + \arctan 4$; (g) $y = (5x + 1)^2$; (h) $y = -(0.5x - 4)^2$;
 (i) $y = ax^2 + |a|$; (j) $y = (a - 1)x^2 - ax$.
43. At the indicated point x_0 , find the value of the derivative of the function (a) $y = x^2 - 5x + 6$, $x_0 = 1$;
 (b) $y = -x^2 + 3x$, $x_0 = -2$; (c) $y = \frac{1}{2}x^2 - x$, $x_0 = 1$; (d) $y = -\frac{1}{2}x^2 + x$, $x_0 = 0$.
44. At the indicated point x_0 , determine the angle between the abscissa axis and the tangent to the curve
 (a) $y = 2x^2 + x$, $x_0 = 2$; (b) $y = -x^2 + 2x$, $x_0 = 3$;
 (c) $y = \frac{x^2}{2} + x\sqrt{3}$, $x_0 = 0$;
 (d) $y = 2x - x^2$, $x_0 = 1.5$; (e) $y = 3x + 4x^2$, $x_0 = -2$.
45. At the indicated point $M(x_0; y_0)$, set up an equation of the tangent to the parabola (a) $y = 3x^2 - 6x + 1$, $M(0; 1)$; (b) $y = -x^2/2 - 4x + 3$, $M(-1; 6.5)$;
 (c) $y = x^2 + 4x + 8$, $M(-2; 4)$.
46. At what value of a is the tangent to the parabola $y = ax^2 + x - 3$ at the point $M(1; a - 2)$ parallel to the straight line $y = 2x - 1$?
47. Two points with abscissas $x_1 = a$, $x_2 = 3a$, $a \neq 0$, are given on the parabola $y = x^2$. A secant is drawn through those points. At what point of the parabola is the tangent to it parallel to the secant?
48. Derive an equation of the tangent to the parabola $y = -2x^2 + 16x - 31$, which is parallel to the abscissa axis.
49. Derive an equation of the tangent to the parabola $y = 2x^2 + 8x$, which is perpendicular to the axis of ordinates.

50. Determine the values of k at which the tangent to the parabola $y = 4x - x^2$ at the point $M(1; 3)$ (a) is a tangent to the parabola $y = x^2 - 6x + k$; (b) cuts the parabola $y = x^2 - 6x + k$ at two points.

Find the critical points of the following functions:

51. (a) $y = x^2 - 6x + 1$; (b) $y = -x^2 + 4x - 3$;
 (c) $y = \frac{1}{2}x^2 + 5x$; (d) $y = -\frac{1}{4}x^2 + 2.5x - \frac{1}{3}$.
52. (a) $y = x^2 - |x|$; (b) $y = -2x^2 + |x + 3|$.
53. (a) $y = |x^2 - 6x + 5|$; (b) $y = -|4x + x^2|$;
 (c) $y = |x^2 + 2x + 6|$.
54. (a) $y = |x^2 - 4| + |x + 3|$;
 (b) $y = |x^2 - 1| + |x^2 - 3|$.
55. (a) $y = x|2 - x|$; (b) $y = (x - 5)|x - 1|$;
 (c) $y = -(x - 2)|x - 2|$.
56. Determine the intervals of the monotone decrease of the function (a) $y = x^2 - 3x + 1$; (b) $y = -x^2 - 4x + 8$; (c) $y = 0.5x^2 - |x|$;
 (d) $y = |0.5x^2 - |x||$.
57. Determine the intervals of the monotone increase of the function (a) $y = \frac{1}{3}x^2 + x - \sqrt{2}$; (b) $y = -2x^2 + 8x - 3$; (c) $y = |x - 4| - x^2$; (d) $y = ||x - 4| - x^2|$.

Determine the points of extremum of the following functions:

58. (a) $y = x^2$; (b) $y = -x^2$; (c) $y = (x - 1)^2$;
 (d) $y = -(2 + x)^2$; (e) $y = x^2 + 2x + 100$;
 (f) $y = -4x^2 + x - 5$.
59. (a) $y = x|x|$; (b) $y = |2x + 3|^2$;
 (c) $y = (x - 2)|x + 1|$.
60. (a) $y = x^2 - 3|x| + 2$; (b) $y = x^2 + 3|x| + 2$;
 (c) $y = x^2 - |x - 1| + 3$.
61. (a) $y = |x^2 - 6|x| + 8|$;
 (b) $y = |x^2 - |x - 2| - 14|$.
62. (a) $y = |x^2 - 1| - |x^2 - 4|$;
 (b) $y = |x^2 - 4| + |x^2 - 25|$.

Find the least and the greatest value of the functions in the indicated intervals:

63. (a) $y = 3x^2 - x + 5$ on the interval $[1; 2]$;
 (b) $y = -4x^2 + 5x - 8$ on the interval $[2; 3]$;
 (c) $y = x^2 - 2x + 5$ on the interval $[-1; 2]$;
 (d) $y = -x^2 + 6x - 1$ on the interval $[0; 4]$.
64. (a) $y = x^2 + |x + 2|$ on the interval $[-3; -1]$;
 (b) $y = (x - 3)|2 - x|$ on the interval $[1; 4]$;
 (c) $y = |x^2 - 4|x||$ on the interval $[-1; 3]$.
65. Suppose x_1 and x_2 ($x_1 \neq x_2$) are zeros of the function $f(x) = ax^2 + bx + c$. Prove that there is a point $x_0 \in (x_1; x_2)$, at which the derivative of the function $f(x)$ is zero.
66. The function $f(x) = ax^2 + bx + c$ is specified on the interval $[x_1; x_2]$, and $f(x_1) = f(x_2) = A$, $x_1 \neq x_2$. Prove that there is a point $x_0 \in (x_1; x_2)$ at which the derivative of the function $f(x)$ is zero.
67. The function $f(x) = ax^2 + bx + c$, $a \neq 0$, is specified on the interval $[x_1; x_2]$. Prove that there is a point $x_0 \in (x_1; x_2)$ such that $f(x_2) - f(x_1) = f'(x_0)(x_2 - x_1)$. Determine the abscissa of the point x_0 .

1.3. Inverse Proportionality

Solve the following equations:

1. (a) $\frac{1}{x} = 5$; (b) $\frac{2}{x-1} = 0$; (c) $\frac{4}{x+2} = a$;
 (d) $\frac{1}{|2-x|} = a$.
2. (a) $\frac{3}{x-1} = \frac{2}{x}$; (b) $\frac{2}{x-1} + x = \frac{x+1}{x-1}$;
 (c) $\frac{x^2+3}{x+3} = 2$; (d) $\frac{1}{x-a} + \frac{1}{x-1} = \frac{2}{(x-a)(x-1)}$.

Solve the following inequalities:

3. (a) $\frac{1}{x} > 1$; (b) $\frac{1}{x} \leq 1$; (c) $\frac{1}{x-2} > -1$;
 (d) $\frac{1}{x+3} \leq -2$; (e) $\frac{a}{x-1} > 1$;
 (f) $\frac{a}{x+1} \geq -1$.

4. (a) $\frac{1}{x-1} - \frac{1}{x+3} > 0$;
 (b) $\frac{1}{2x-3} \leq \frac{1}{2x+5}$.
5. (a) $\frac{x^2-5x+4}{x-4} \geq 0$; (b) $\frac{x+3}{3x^2+10x+3} < 0$.
6. (a) $\frac{2}{|x+2|} \leq 1$; (b) $\frac{2}{|x-2|} > \left| \frac{-3}{2x-1} \right|$;
 (c) $\frac{x^2-4x+4}{x^2-6x+9} + \frac{|x-2|}{|x-3|} - 12 < 0$;
 (d) $x - 2 \left(1 - \frac{1}{a} \right) < \frac{2(x+1)}{3a}$.

Construct the graphs of the following functions:

7. (a) $y = \frac{2}{x}$; (b) $y = -\frac{1}{x}$;
 (c) $y = \frac{1}{2+x}$; (d) $y = \frac{1}{1-x}$.
8. (a) $y = \frac{1}{|x-3|}$; (b) $y = -\frac{1}{|2x+1|}$.
9. (a) $y = 2 + \frac{1}{x}$; (b) $y = 1 - \frac{2}{x}$;
 (c) $y = \frac{1}{x+1} - \frac{1}{2}$; (d) $y = -3 - \frac{1}{x-2}$.
10. (a) $y = \frac{x+1}{x-1}$; (b) $y = \frac{x-1}{x+1}$;
 (c) $y = \frac{2x-2}{x+3}$; (d) $y = \frac{x+2}{3-x}$.
11. (a) $y = \frac{1}{2-|x|}$; (b) $y = \frac{2}{|x-1|-1}$.
12. (a) $y = \frac{|x-4|}{x+2}$; (b) $y = \frac{1-x}{|x+3|}$.
13. (a) $y = \frac{|x-1|}{|x|-1}$; (b) $y = \frac{|x|-2}{|x+3|-1}$.
14. (a) $y = \frac{x-1}{|x-1|} + \frac{|x+1|}{x+1} - \frac{1}{x}$;
 (b) $y = -\left| \frac{x^2-9}{x+3} - x + \frac{2}{x-1} \right|$.
15. Find the derivative of the function (a) $y = \frac{1}{x}$;
 (b) $y = -\frac{2}{x}$; (c) $y = \frac{1}{2(x+1)}$; (d) $y = \frac{1}{1-x}$;

- (e) $y = 1 - \frac{2}{x+2}$; (f) $y = -3 + \frac{1}{2x-1}$;
 (g) $y = \frac{2x-3}{x+1}$; (h) $y = \frac{x-4}{1-3x}$.
16. At the indicated point, find the value of the derivative of the function (a) $y = \frac{3}{x}$, $x_0 = 1$;
 (b) $y = \frac{1}{|x|}$, $x_0 = -2$; (c) $y = \frac{2x-1}{x-1}$,
 $x_0 = 0$; (d) $y = \frac{|x-3|}{x+1}$, $x_0 = 1$.
17. At the indicated point x_0 , determine the angle between the x -axis and the tangent to the curve (a) $y = \frac{1}{1-x}$, $x_0 = 2$; (b) $y = \frac{x-2}{x+3}$, $x_0 = 0$; (c) $y = \frac{1-2x}{|x|}$,
 $x_0 = 3$; (d) $y = \frac{|x-1|}{|x+3|}$, $x_0 = -2$;
 (e) $y = \frac{1}{x} - \frac{1}{1-x}$, $x_0 = 2$; (f) $y = \frac{2-3x}{2x+1} + \frac{1}{|x|}$,
 $x_0 = -1$.
18. At the indicated point $P(x_0; y_0)$, derive an equation of the tangent to the curve (a) $y = -\frac{3}{x}$, $P(3; -1)$;
 (b) $y = \frac{1}{x-2}$, $P(1; -1)$; (c) $y = \frac{x-3}{|x+2|}$, $P(0; -\frac{3}{2})$;
 (d) $y = \frac{|x-2|}{2x+1} - \frac{1}{|x-3|}$, $P(1; -\frac{1}{6})$.
19. On the hyperbola $y = \frac{x-1}{x+1}$, find the point M at which the tangent to that hyperbola (a) is parallel to the straight line $y = 2x + 1$; (b) is perpendicular to the straight line $y = -\frac{1}{8}x - 3$.
20. Show that the tangents drawn to the hyperbola $y = \frac{x-4}{x-2}$ at the points of its intersection with the axes of coordinates are parallel to each other.
21. Set up an equation of the tangent to the hyperbola $y = \frac{x+9}{x+5}$, which passes through the origin of coordinates.

22. Prove that the function $y = \frac{ax+b}{cx+d}$ is strictly monotonic on any interval $(x_1; x_2)$, provided that $ad \neq bc$, $c \neq 0$, $x \neq -d/c \notin (x_1; x_2)$.
23. Find the greatest and the least value of the function
 (a) $y = (x-3)/(x+1)$ on the interval $[0; 2]$;
 (b) $y = (2x+1)/(x-2)$ on the interval $[-1; 1]$.
24. The function $y = k/x$, $k > 0$ is specified on the interval $[x_1; x_2]$. Prove that there is a point $x_0 \in (x_1; x_2)$ such that $y(x_2) - y(x_1) = y'(x_0)(x_2 - x_1)$. Find the coordinates of the point x_0 .

1.4. Equations and Inequalities of Higher Degrees.

A Rational Function

- Solve the equation (a) $(x-1)(x^2+4x+3) = 0$;
 (b) $(2x+3)(x^2-x+1) = 0$; (c) $x^3+27 = 0$;
 (d) $8x^3-1 = 0$; (e) $x^3-1+x^2-1 = 0$;
 (f) $x^3+8+x^2-4 = 0$; (g) $x^3+1+x+1 = 0$.
 (h) $x^3-8+x-2 = 0$; (i) $x^3+x^2+x+1 = 0$;
 (j) $x^3-x^2+x-1 = 0$.
- The equation $x^3+ax^2+bx+c = 0$, where a, b, c are integers, has a rational root x_1 . Prove that x_1 is an integer and that c is exactly divisible by x_1 .
- Find the rational roots of the equation (a) $x^3+2x^2-x-2 = 0$;
 (b) $x^3-x^2-8x+12 = 0$;
 (c) $x^3-9x^2+27x-27 = 0$; (d) $x^3+x^2-3 = 0$.
 (e) $6x^3+7x^2-1 = 0$; (f) $2x^3+x^2+5x-3 = 0$.
- Suppose x_1, x_2, x_3 are roots of the equation $ax^3+bx^2+cx+d = 0$, $a \neq 0$. Prove that $x_1+x_2+x_3 = -b/a$, $x_1x_2+x_2x_3+x_3x_1 = c/a$, $x_1x_2x_3 = -d/a$.
- Given the equation $x^3+px+q = 0$. Find the sum of the squares of its roots.
- Solve the equation $x^3+3x-3 = 0$.
- Solve the equation (a) $(x-1)(x+3)(x^2-x-6) = 0$;
 (b) $(x^2-3x+2)(x^2+7x+10) = 0$;
 (c) $(x^2-x-3)(x^2-2x+2) = 0$; (d) $(x^2-x+1)(x^2-2x+3) = 0$;
 (e) $x^4-16-5x(x^2-4) = 0$;
 (f) $x^4+11x^2+10+7x(x^2+1) = 0$.

8. The equation $x^4 + ax^3 + bx^2 + cx + d = 0$, where a, b, c, d are integers, has a rational root x_1 . Prove that x_1 is an integer and that d can be divided by x_1 without a remainder.
9. Find the rational roots of the equation (a) $x^4 + 2x^3 - 16x^2 - 2x + 15 = 0$; (b) $x^4 - 7x^3 + 5x^2 + 4x + 12 = 0$; (c) $x^4 + x^3 - 5x - 5 = 0$; (d) $x^4 + x^3 - 1 = 0$; (e) $6x^4 - x^3 + 5x^2 - x - 1 = 0$.

Solve the following equations:

10. (a) $2x^4 - 5x^2 + 2 = 0$; (b) $x^4 - 2x^2 - 3 = 0$.
11. (a) $(x - 1)^4 + (x + 1)^4 = 16$;
 (b) $(2x - 3)^4 + (2x - 5)^4 = 2$.
12. (a) $(x^2 + 2x)^2 - 7(x^2 + 2x) + 6 = 0$;
 (b) $\frac{1}{2x^2 - x + 1} + \frac{3}{2x^2 - x + 3} = \frac{10}{2x^2 - x + 7}$.
13. (a) $(x - a)x(x + a)(x + 2a) = 3a^4$;
 (b) $(6x + 5)^2(3x + 2)(x + 1) = 35$.
14. (a) $x^2 + 4/x^2 - 8(x - 2/x) - 4 = 0$;
 (b) $4x^4 + 6x^3 - 10x^2 - 9x + 9 = 0$;
 (c) $\frac{(x+1)^5}{x^5+1} = \frac{81}{11}$; (d) $(x^2 - 6x - 9)^2 = x^3 - 4x^2 - 9x$.
15. (a) $x^2 + \frac{25x^2}{(x+5)^2} = 11$;
 (b) $(x^2 - 16)(x - 3)^2 + 9x^2 = 0$.
16. (a) $x^4 + 4x - 1 = 0$; (b) $x^4 - 4x^3 - 1 = 0$;
 (c) $x^4 - 2x^2 - 400x = 9999$.
17. (a) $(x^3 - 2x) - (x^2 + 2)a - 2a^2x = 0$;
 (b) $(x^2 - a)^2 - 6x^2 + 4x + 2a = 0$.
18. $x^4 - 4x^3 - 10x^2 + 37x - 14 = 0$, if it is known that the left-hand side of the equation can be decomposed into factors with integral coefficients.

Solve the following inequalities:

19. (a) $(x + 2)(x - 1)(x - 3) > 0$;
 (b) $(x + 2)x(x - 1)(x - 2) < 0$;
 (c) $(x + 4)^5(x + 3)^6(x + 2)^7(x - 1)^8 \leq 0$;
 (d) $(x + 3)^n(x - 2) < 0, n \in \mathbb{N}$.

20. (a) $x^3 - 3x^2 - 10x + 24 > 0$; (b) $x^3 + 4x^2 + 5x + 2 \leq 0$; (c) $2x^3 - 3x^2 + 7x - 3 > 0$.
21. (a) $x^4 - 3x^3 + x^2 + 3x - 2 \geq 0$; (b) $x^4 + 6x^3 + 6x^2 + 6x + 5 < 0$.
22. (a) $3x^4 - 10x^2 + 3 > 0$;
 (b) $3x^2(x - 4)^2 < 32 - 5(x - 2)^2$.
23. (a) $(x^2 - x)^2 + 3(x^2 - x) + 2 \geq 0$;
 (b) $x(x + 1)(x + 2)(x + 3) < 48$.
24. (a) $(x + 1)^4 > 2(1 + x^4)$;
 (b) $x^4 - x^3 - 10x^2 + 2x + 4 < 0$.
25. Prove that the polynomial $P(x) = x^8 - x^5 + x^2 - x + 1$ is positive for any $x \in \mathbb{R}$.
26. Assume $P(x) = a_0x^m + a_1x^{m-1} + \dots + a_{m-1}x + a_m$ and $Q(x) = b_0x^n + b_1x^{n-1} + \dots + b_{n-1}x + b_n$, $m \in \mathbb{N}$, $n \in \mathbb{N}$, $Q(x) \not\equiv 0$. Prove that the inequalities $P(x)/Q(x) > 0$ and $P(x)Q(x) > 0$ are equivalent.

Solve the following inequalities:

27. (a) $\frac{1}{x} < \frac{2}{x-2}$; (b) $\frac{x+4}{x-2} < \frac{2}{x+1}$;
 (c) $\frac{1}{x+1} - \frac{1}{x} \leq \frac{1}{x-1} - \frac{1}{x-2}$;
 (d) $\frac{x^2-x+1}{x-1} + \frac{x^2-3x+1}{x-3} > 2x - \frac{1}{4x-8}$;
 (e) $\frac{x^3-2x^2+5x+2}{x^2+3x+2} \geq 1$;
 (f) $\frac{1}{x+5} + \frac{1}{x-7} + \frac{1}{x-5} + \frac{1}{x+7} > 0$.
28. (a) $\frac{1}{x^2+x} \leq \frac{1}{2x^2+2x+3}$;
 (b) $\frac{1}{x-1} - \frac{4}{x-2} + \frac{4}{x-3} - \frac{1}{x-4} < \frac{1}{30}$;
 (c) $\frac{4x-17}{x-4} + \frac{10x-13}{2x-3} > \frac{8x-30}{2x-7} + \frac{5x-4}{x-1}$.
29. (a) $x^2 + \frac{x^2}{(x+1)^2} < \frac{5}{4}$; (b) $x^2 + \frac{4x^2}{(x-2)^2} \leq 5$.
30. (a) $\frac{(x+1)^4}{x(x^2+1)} > \frac{128}{15}$;
 (b) $x^3 - \frac{1}{x^3} \geq 4\left(x - \frac{1}{x}\right)$.

31. $\frac{x+6}{x-6} \left(\frac{x-4}{x+4} \right)^2 + \frac{x-6}{x+6} \left(\frac{x+9}{x-9} \right)^2 < \frac{2x^2+72}{x^2-36}$.
32. $|x^3 - x| \leq x$. 33. $\frac{4}{|x+1|-2} \geq |x-1|$.
34. Find the derivative of the function (a) $y = x^3 - 6x^2 + 1$;
 (b) $y = -x^3 + \frac{1}{3}x - 2$; (c) $y = x^4 - 6x + 3$;
 (d) $y = -\frac{1}{2}x^4 + x^3$; (e) $y = (x+2)(x^2 - x + 5)$;
 (f) $y = (3-x)(x-x^2)$; (g) $y = (x^2+x+2)(x^2+2x+3)$;
 (h) $y = x(x-1)(x-2)(x-3)$; (i) $y = \frac{x}{1+x^2}$;
 (j) $y = \frac{1-x}{2+x^2}$; (k) $y = \frac{x^3-x}{x+3}$;
 (l) $y = \frac{x^4+4x}{(x+1)^2}$; (m) $y = \frac{(x^2-1)(x+3)}{x-4}$;
 (n) $y = x^3 + \frac{1}{1-x}$; (o) $y = (2-3x)^{30}$;
 (p) $y = \left(6x^2 - \frac{4}{x} + 1\right)^8$; (q) $y = \left(\frac{x^2+1}{x^2-1}\right)^2$;
 (r) $y = (x^4 - x^3 + 5x^2 - 2)^8$.
35. At the indicated point x_0 , calculate the value of the derivative of the function (a) $y = (x^2 - 3x + 3)(x^2 + 2x - 2)$, $x_0 = 0$; (b) $y = (x^3 - 3x + 2)(x^4 + x^2 + 1)$, $x_0 = 1$; (c) $y = (x^2 - 1)(x^2 - 4)(x^2 - 9)$, $x_0 = -2$;
 (d) $y = \frac{x^5}{(x-2)^2}$, $x_0 = 1$; (e) $y = \frac{3}{(1-x^2)(1-x^3)}$, $x_0 = 0$;
 (f) $y = \frac{1}{x+2} + \frac{3}{x^2+1}$, $x_0 = -1$; (g) $y = (1+x^3) \times$
 $\times (5 - 1/x^2)$, $x_0 = a$; (h) $y = \frac{a-x}{1+x^2}$, $x_0 = a$; (i) $[(x^2 +$
 $+ x + 1)(x^2 - x + 1)]^5$, $x_0 = 0$; (j) $y = x(x-1)(x-2) \dots$
 $\dots (x-n)$, $x_0 = 0$, $n \in \mathbb{N}$.
36. At the given point $P(x_0; y_0)$, set up an equation of the tangent to the curve (a) $y = -\frac{1}{3}x^3 + x^2 - x$, $P(0; 0)$; (b) $y = x^3 - 3x^2 + 2$, $P(0; 2)$; (c) $y = (x-2)^2(x+1)$, $P(1; 2)$; (d) $y = 2x^4 - x^3 + 1$, $P(-1; 4)$; (e) $y = (x-4)^3(2x+1)$, $P(2; -40)$;
 (f) $y = x - \frac{1}{x}$, $P(1; 0)$; (g) $y = \frac{1}{x^1} + 2$, $P(1; 3)$.

37. On the curve $y = x^3 - 3x + 2$, find the points at which the tangent is parallel to the straight line $y = 3x$.
38. At which point is the tangent to the graph of the function $f(x) = \frac{1}{3}x^3 - \frac{3}{2}x^2 - 9x + 8$ parallel to the bisector of the first and the third quadrant?
39. At which points of the curve $y = x^3 + x - 2$ is the tangent to it parallel to the line $y = 4x + 5$?
40. Find a point on the curve $y = x^2(x - 2)^2$ at which the tangent to it is parallel to the line $y = 24x - 1$.
41. Find a point on the curve $y = 1/(1 + x^2)$ at which the tangent is parallel to the abscissa axis.
42. Show that any tangent to the curve $y = x^5 + 8x + 1$ makes an acute angle with the x -axis.

Find the critical points of the following functions:

43. (a) $y = 2x^3 - \frac{5}{2}x^2 + x - \sqrt{3}$;
 (b) $y = x^3 - 3\sqrt[3]{3}x^2 + 3\sqrt[3]{9}x - 3\sqrt[3]{3}$;
 (c) $y = 3x^3 - x^2 + 5x + 0.7$; (d) $y = (x + 2)^2(3x - 1)$;
 (e) $y = x^3 + 3|x|$; (f) $y = |x^3| - 9x$.
44. (a) $y = x^4 + 8x^2 - 64x + 1$; (b) $y = 3x^4 + 16x^3 + 6x^2 - 72x - 3$; (c) $y = x^4 + 6x^2 + 5$; (d) $y = -x^4 + 4|x|$;
 (e) $y = x^4 + 8|x^3|$.
45. (a) $y = \frac{x^5}{5} - \frac{2}{3}x^3 - 3(x + 1)$; (b) $y = 0.6x^5 - 13x^3 + 108x - 5$; (c) $y = \left(\frac{x^5}{5} - \frac{3}{2}x^4 + 3x^3\right) + 5\left(\frac{x^3}{3} - \frac{3}{2}x^2\right) + 4x - 7$; (d) $y = \frac{x^7}{7} - 7x + \pi$; (e) $y = x^2 + \frac{16}{x}$.
46. Find the intervals of the monotone decrease of the function (a) $y = 2x^3 + 3x^2 - 12x + 15$; (b) $y = x^4 + \frac{1}{3}x^3 - 2$;
 (c) $y = x^5 - 20x^3 + 1$; (d) $y = \frac{x^2 - 3x + 2}{x^2 + 3x + 2}$.
47. Find the intervals of the monotone increase of the function (a) $y = x^3 - 5x^2 + 3x - 11$; (b) $y = -x^3 + 6x^2 - 9x + 5$; (c) $y = 0.25x^4 + x^2 - 6$; (d) $y = \frac{x+2}{x^2-1}$;
 (e) $y = \frac{1-x+x^2}{1+x+x^2}$.

48. Determine the points of extremum of the function

(a) $y = x^3 + 3x^2 - 45x + 1$; (b) $y = \frac{x^3}{3} - 2x^2 + 4x - 3$; (c) $y = |3x - 1| - x^3$; (d) $y = (x - 1)^3(x + 2)$; (e) $y = (x + 3)^2(x - 4)^2$;
(f) $y = 2x^2 + \frac{4}{x}$; (g) $y = \frac{2x-1}{(x-1)^2}$.

49. Find the absolute value of the difference between the extrema of the function

$$y = x^3 + 3x^2 - 3x + 1.$$

50. Find the least and the greatest value of the function on the indicated intervals

(a) $y = x^3 + 9x - 3$ on the interval $[-1; 0]$;
(b) $y = 6x - x^3$ on the interval $[-2; 1]$;
(c) $y = (x + 2)^3(x - 1)$ on the interval $[-1; 2]$;
(d) $y = x^5 - 5x^4 + 5x^3 + 4$ on the interval $[-1; 2]$;
(e) $y = \frac{3x^2 + 4x + 4}{x^2 + x + 1}$ on the interval $[-2; -1]$.

Investigate the behaviour of the following functions with the aid of their derivatives and construct their graphs:

51. $y = x^3 - 3x^2 + 4$. 52. $y = -x(x^2 - 4) - 3$.

53. $y = (x + 2)^2(x - 1)^2$. 54. $y = -x^4 + 2x^2 + 8$.

55. $y = (x - 1)^3(x + 1)^2$. 56. $y = x + 1/x$.

57. $y = \frac{x}{1+x^2}$. 58. $y = \frac{x}{x^2-1}$.

59. $y = x^2 + \frac{1}{x^2}$. 60. $y = \frac{x^3}{3-x^2}$.

61. $y = \frac{1}{x} + 4x^2$.

1.5. Linear Systems of Equations and Inequalities

Solve the following systems of equations:

1. (a) $\begin{cases} 3x - y = 0, \\ -x + y = 0; \end{cases}$ (b) $\begin{cases} x - 2y = 0, \\ 2x - 4y = 0; \end{cases}$
(c) $\begin{cases} 0 \cdot x - 0 \cdot y = 0, \\ 0 \cdot x + 0 \cdot y = 0; \end{cases}$ (d) $\begin{cases} 0 \cdot x + y = 0, \\ 0 \cdot x - 0 \cdot y = 0; \end{cases}$

- (e) $\begin{cases} 0 \cdot x + 0 \cdot y = -1, \\ 0 \cdot x + 0 \cdot y = 2. \end{cases}$
2. (a) $\begin{cases} 3x + 2y = 1, \\ -x + 5y = -6; \end{cases}$ (b) $\begin{cases} 4x - 8y = 3, \\ x - 2y = 3/4; \end{cases}$
- (c) $\begin{cases} 3x + y = -1, \\ 9x + 3y = -2; \end{cases}$ (d) $\begin{cases} y - 4x = a, \\ 8x - 2y = 1. \end{cases}$
3. At what values of k are the following systems of equations consistent:
- (a) $\begin{cases} kx + y = 2, \\ x - y = 3; \end{cases}$ (b) $\begin{cases} kx + 4y = 4, \\ 3x + y = 1; \end{cases}$
- (c) $\begin{cases} 3x + (k-1)y = k+1, \\ (k+1)x + y = 3? \end{cases}$
4. Find all values of m for which the following systems of equations have no solutions:
- (a) $\begin{cases} 2x + (9m^2 - 2)y = 3m, \\ x + y = 1; \end{cases}$
- (b) $\begin{cases} m^2x + (2-m)y = m^3 + 4, \\ mx + (2m-1)y = m^5 - 2; \end{cases}$
- (c) $\begin{cases} 2mx + y = 6m^2 - 5m + 1, \\ x + 2my = 0. \end{cases}$
5. Find c and d for which the system of equations
- $$\begin{cases} (c+1)^2x - (c+1)y = -c, \\ (d-1)x + (5-2d)y = c+4 \end{cases}$$
- has the unique solution $x = 1, y = 1$.
6. The ordered pair of numbers $(1; 3)$ is one of the solutions of the system of equations
- $$\begin{cases} ax - by = 2a - b, \\ (c+1)x + cy = 10 - a + 3b. \end{cases}$$
- Find the numerical values of a, b and c .
7. Find $b \in \mathbb{R}$ such that the systems of equations
- (a) $\begin{cases} 3x + y = a, \\ ax - y = b; \end{cases}$ (b) $\begin{cases} x - 2y = a, \\ ax + 3y = b \end{cases}$
- have at least one solution for any $a \in \mathbb{R}$.

8. Find all a and b for which the following systems of equations are equivalent:

$$\begin{cases} ax + 2y = b + 1, \\ x + y = 3 \end{cases} \quad \text{and} \quad \begin{cases} 2x + y = a^2 + 2, \\ x + 3y = 3. \end{cases}$$

9. At what values of k does the system of equations

$$\begin{cases} x + ky = 3, \\ kx + 4y = 6, \end{cases}$$

possess solutions simultaneously satisfying the inequalities $x > 1$ and $y > 0$?

10. At what values of a do the solutions of the system of equations

$$\begin{cases} -2x + y = a^2 - 1, \\ 3x + 2y = 2a^2 + 7a + 5 \end{cases}$$

satisfy the inequality $x\sqrt{y} + 3 > 0$?

Solve the following systems of equations:

$$11. \begin{cases} \frac{4}{2x+y-1} + \frac{3}{x+2y-3} = 4.75, \\ \frac{3}{2x+y-1} - \frac{2}{x+2y-3} = 2.5. \end{cases}$$

$$12. (a) \begin{cases} |x| + y = 4, \\ x + 3|y| = 6; \end{cases} \quad (b) \begin{cases} \sqrt{(x+y)^2} = 5, \\ \sqrt{(x-y)^2} = 1. \end{cases}$$

13. Find $x \in \mathbb{N}$ and $y \in \mathbb{N}$ satisfying the equation $23x + 34y = 1000$.

14. On the plane xOy , indicate the points satisfying the inequality (a) $|x - y| \leq 1$; (b) $|x + y| \geq 2$; (c) $|x| - |y| \geq 1$; (d) $|x| + |y| \leq 3$; (e) $|x - 1| + |y + 1| \geq 2$; (f) $|x + y| + |x - y| \leq 2$.

15. On the plane xOy , indicate the points satisfying the system of inequalities

$$\begin{cases} 3y < 5, \\ y + 2x < 11, \\ 4y + x > 9. \end{cases}$$

Find all integral values of x and y satisfying this system.

16. At what $a \in \mathbb{R}$ does the point $(a; a^2)$ lie in the interior of the triangle formed at the intersection of the lines $y = x + 1$, $y = 3 - x$, $y = -2x$?

Solve the following systems of equations:

$$17. \begin{cases} x + y - z = 0, \\ 2x - y + 3z = 9, \\ -3x + 4y + 2z = 11. \end{cases} \quad 18. \begin{cases} x = 3t - 2, \\ y = -4t + 1, \\ z = 4t - 5, \\ 4x - 3y - 6z = 5. \end{cases}$$

$$19. \begin{cases} 2x + 3y + z - 1 = 0, \\ \frac{x-1}{1} = \frac{y+1}{-2} = \frac{z}{6}. \end{cases}$$

$$20. \begin{cases} \frac{x+2}{-2} = \frac{y-1}{3} = \frac{z-3}{2}, \\ x + 2y - 2z + 6 = 0. \end{cases}$$

21. Given the system of equations

$$\begin{cases} \frac{2}{3}x + \frac{4}{5}y + \frac{5}{6}z = 61, \\ x + y + z = 79. \end{cases}$$

(a) Find the value of the sum $\frac{2}{5}y + \frac{z}{2}$; (b) among all natural solutions of the system, find the solution for which x assumes the greatest value.

22. The inequalities $f(-1) < 1$, $f(1) > -1$, $f(3) < -4$ are known to be satisfied for a certain function $f(x) = ax^2 + bx + c$, $a \neq 0$. Determine the sign of the coefficient a .
23. Represent the set $\{(x; y; z) \mid |x| + |y| + |z| \leq 1\}$ graphically and name the figure you have obtained.

1.6. Systems of Equations and Inequalities in Several Higher-Degree Variables

Solve the following systems of equations:

$$1. \text{ (a) } \begin{cases} x^2 - xy + 3y^2 + 2x - 5y - 4 = 0, \\ x + 2y = 4; \end{cases} \quad \text{(b) } \begin{cases} 2xy - y^2 + 5x + 20 = 0, \\ 3x + 2y - 3 = 0; \end{cases} \quad \text{(c) } \begin{cases} x^2 - 4y^2 = 200, \\ x + 2y = 100; \end{cases}$$

$$\begin{aligned}
& \text{(d)} \begin{cases} x^2 + 9y^2 + 6xy - 6x - 18y - 40 = 0, \\ x + 30 = 2y. \end{cases} \\
2. \text{ (a)} \begin{cases} x + y = 5, \\ xy = 6; \end{cases} \text{ (b)} \begin{cases} x - y = 5, \\ xy = -4; \end{cases} \text{ (c)} \begin{cases} x^2 + y^2 = 10, \\ x + y = 4; \end{cases} \\
\text{(d)} \begin{cases} \frac{1}{x^2} + \frac{1}{y^2} = 13, \\ \frac{1}{x} - \frac{1}{y} = 1; \end{cases} \text{ (e)} \begin{cases} x^3 + y^3 = 7, \\ x + y = 1; \end{cases} \\
\text{(f)} \begin{cases} x^4 + y^4 = 17, \\ x + y = 3; \end{cases} \text{ (g)} \begin{cases} x^5 + y^5 = 275, \\ x + y = 5; \end{cases} \\
\text{(h)} \begin{cases} x^3 - y^3 = 63, \\ xy = 4. \end{cases} \\
3. \text{ (a)} \begin{cases} x + y + xy = -11, \\ x^2 + y^2 + xy = 13; \end{cases} \text{ (b)} \begin{cases} x^2y - xy^2 = 30, \\ x + xy - y = 13; \end{cases} \\
\text{(c)} \begin{cases} (x + 0.2)^2 + (y + 0.3)^2 = 1, \\ x + y = 0.9; \end{cases} \\
\text{(d)} \begin{cases} x + y + x/y = 1/2, \\ \frac{(x+y)x}{y} = -\frac{1}{2}; \end{cases} \\
\text{(e)} \begin{cases} x^3y + x^2y^2 + 2x^2y^2 + x^2y^3 + xy^3 = 30, \\ x^2y + xy + x + y + xy^2 = 11. \end{cases} \\
4. \text{ (a)} \begin{cases} 2x^2 + xy - 45y^2 = 0, \\ 2x + 9y^2 = 4; \end{cases} \text{ (b)} \begin{cases} x^2 - 5xy = 16, \\ 2xy + y^2 = 3; \end{cases} \\
\text{(c)} \begin{cases} 2x^2 + y^2 + 3xy + 12, \\ (x + y)^2 - \frac{1}{2}y^2 = 7; \end{cases} \text{ (d)} \begin{cases} x^3 + xy^2 = 10, \\ x^2y - y^3 = -3. \end{cases} \\
5. \text{ (a)} \begin{cases} 10x^2 + 5y^2 - 2xy - 38x - 6y + 41 = 0, \\ 3x^2 - 2y^2 + 5xy - 17x - 6y + 20 = 0; \end{cases} \\
\text{(b)} \begin{cases} y^2(x^2 - 3) + xy + 1 = 0, \\ y^2(3x^2 - 6) + xy + 2 = 0. \end{cases} \\
6. \text{ (a)} \begin{cases} \frac{x}{y}(x + y - 2) = \frac{2}{3}, \\ \frac{y}{x}(x + y - 1) = 9; \end{cases} \text{ (b)} \begin{cases} \frac{x}{y} + \frac{y}{3} = 3, \\ \frac{x}{2} + \frac{3}{y} = \frac{3}{2}. \end{cases}
\end{aligned}$$

$$7. (a) \begin{cases} y^2 - |xy| + 2 = 0, \\ 8 - x^2 = (x + 2y)^2; \end{cases} \quad (b) \begin{cases} |xy - 2| = 6 - x^2, \\ 2 + 3y^2 = 2xy. \end{cases}$$

8. Find all pairs of numbers x and y for which the conditions $x^2 - 2xy + 12 = 0$, $x^2 + 4y^2 \leq 60$ and $x \in \mathbb{Z}$ are simultaneously fulfilled.

9. Find natural solutions of the system

$$\begin{cases} x = y + 2, \\ xy \leq 17, \\ (y + 1)/(x + 2) < 1/2. \end{cases}$$

10. Find all values of a for which the set

$$\{(x; y) \mid x^2 + y^2 + 2x \leq 1\}$$

$$\cap \{(x; y) \mid x - y + a \geq 0\}$$

contains only one point. Find that point.

11. Solve the equation (a) $(x - 1)^2 + (y + 5)^2 = 0$;

(b) $x^2 + y^2 - 2x + 6y + 10 = 0$;

(c) $(x + y - a)^2 + (y - 1)^2 + (x + 3)^2 = 0$.

Solve the following systems of equations:

$$12. (a) \begin{cases} x + 2y - z = 5, \\ 3x - 4y + z = 1, \\ x^2 + y^2 + z^2 = 6; \end{cases} \quad (b) \begin{cases} 2u + v + w = 6, \\ 3u + 2v + w = 9, \\ 3u^3 + 2v^3 + w^3 = 27. \end{cases}$$

$$13. \begin{cases} x + y + z = 2, \\ xy + yz + zx = -5, \\ x^2 + y^2 - z^2 = 12. \end{cases} \quad 14. \begin{cases} xy + x + y = 7, \\ yz + y + z = -3, \\ xz + x + z = -5. \end{cases}$$

$$15. \begin{cases} x^2 - yz = 14, \\ y^2 - xz = 28, \\ z^2 - xy = -14. \end{cases} \quad 16. \begin{cases} x^2 + xy + y^2 = 3, \\ y^2 + yz + z^2 = 7, \\ z^2 + zx + x^2 = 19. \end{cases}$$

$$17. \begin{cases} xy + xz = 8, \\ yz + xy = 9, \\ xz + yz = -7. \end{cases} \quad 18. \begin{cases} 5xy/(x + y) = 1, \\ 7yz/(y + z) = 1, \\ 6xz = x + z. \end{cases}$$

$$19. \begin{cases} 4xz + y^2 + 2z^2 = -3, \\ 4xz + x^2 + 2z^2 = 1, \\ 8yz + y^2 + 2z^2 = 1. \end{cases} \quad 20. \begin{cases} y^3 = 9x^2 - 27x + 27, \\ z^3 = 9y^2 - 27y + 27, \\ x^3 = 9z^2 - 27z + 27. \end{cases}$$

21. Find all triples of the integers $(x; y; z)$ for which the relation $5x^2 + y^2 + 3z^2 - 2yz = 30$ is satisfied.
22. Hatch the set of points of the coordinate plane defined by the system of inequalities
- (a) $\begin{cases} y - 2x \leq 0, \\ x^2 + y^2 - 5 \leq 0; \end{cases}$ (b) $\begin{cases} x^2 + y \leq 0, \\ 2x^2 + y - 1 \leq 0. \end{cases}$
23. Represent on the plane the set of points $(x; y)$ whose coordinates satisfy the systems of inequalities
- (a) $\begin{cases} 2y \geq x^2, \\ y \leq -2x^2 + 3x; \end{cases}$ (b) $\begin{cases} y + x^2 \leq 0, \\ y - 2x + 3 \geq 0, \\ y + 1 \leq 0; \end{cases}$
- (c) $\begin{cases} x^2 + y^2 \geq 1, \\ x^2 + y^2 \leq 16. \end{cases}$

Chapter 2

TRANSCENDENTAL FUNCTIONS, EQUATIONS AND INEQUALITIES

2.1. Irrational Equations and Inequalities

Solve the following systems of equations:

1. $\sqrt{x+1} = a.$
2. $\sqrt{x+3} = \sqrt{a-x}.$
3. $\sqrt{4+2x-x^2} = x-2.$
4. (a) $11+2x = \sqrt{22-x};$
 (b) $21 + \sqrt{2x-7} = x;$
 (c) $2\sqrt{x+5} = x+2;$
 (d) $3x - \sqrt{18x+1} + 1 = 0.$
5. (a) $\sqrt{x+10} + \sqrt{x-2} = 6;$
 (b) $\sqrt{x} - \sqrt{x+3} = 1;$
 (c) $\sqrt{15-x} + \sqrt{3-x} = 6;$

$$(d) \sqrt{\frac{20+x}{x}} + \sqrt{\frac{20-x}{x}} = \sqrt{6};$$

$$(e) \sqrt{|x|+1} - \sqrt{|x|} = a;$$

$$(f) \sqrt{x^2+5x+3} - \sqrt{x^2+5x-2} = 1.$$

$$6. (a) \sqrt{2x+3} - \sqrt{x+1} = 1;$$

$$(b) \sqrt{2x+3} + \sqrt{x+1} = 5;$$

$$(c) \sqrt{2x-3} + \sqrt{4x+1} = 4;$$

$$(d) \sqrt{x+4} + \sqrt{2x+6} = 7;$$

$$(e) \sqrt{2x-4} - \sqrt{x+5} = 1;$$

$$(f) \sqrt{5x+7} - \sqrt{2x+3} = \sqrt{3x+4};$$

$$(g) \sqrt{x^2+x+4} + \sqrt{x^2+x+1} = \sqrt{2x^2+2x+9};$$

$$(h) \sqrt{x^2-9x+24} - \sqrt{6x^2-59x+149} = |5-x|.$$

$$7. (a) x + 12\sqrt{x} - 64 = 0;$$

$$(b) \frac{x-4}{\sqrt{x}+2} = x-8;$$

$$(c) (x-3)^2 + 3x - 22 = \sqrt{x^2-3x+7};$$

$$(d) 2x^2 + 3x - 5\sqrt{2x^2+3x+9} + 3 = 0;$$

$$(e) x\sqrt{x^2+15} - 2 = \sqrt{x}\sqrt[4]{x^2+15};$$

$$(f) \sqrt{\frac{x+1}{x-1}} - \sqrt{\frac{x-1}{x+1}} = \frac{3}{2};$$

$$(g) \sqrt{\frac{x+a}{x-a}} + 2\sqrt{\frac{x-a}{x+a}} = 3;$$

$$(h) \sqrt{2-x} + \frac{4}{\sqrt{2-x}+3} = 2;$$

$$(i) 4x^2 + 12x\sqrt{1+x} = 27(1+x).$$

$$8. \sqrt{7-x} + \sqrt{x-3} = a.$$

$$9. \text{Find the domain and the range of the function (a) } y = \sqrt{2-x} + \sqrt{1+x}; \text{ (b) } y = \sqrt{-4x^2+4x+3}.$$

Solve the following equations:

10. $\sqrt[4]{x-2} + \sqrt[4]{4-x} = 2.$

11. $\sqrt{x^2+ax-2a} = x+1.$

12. $\sqrt{2x-1} - x + a = 0.$

13. $\sqrt{a^2-x} \sqrt{x^2+a^2} = a-x.$

14. $\sqrt{x} - \sqrt{x-a} = a.$

15. $\sqrt{x + \sqrt{a^2 + 2a - 3}} + \sqrt{x + a + \sqrt{2 - 2a + 2a^2 - a^3}} = a \sqrt{1-x}.$

Solve the following inequalities:

16. $(x-1)\sqrt{x^2-x-2} \geq 0.$ 17. $\sqrt{\frac{x-2}{1-2x}} > -1.$

18. $\sqrt{4-x^2} + \frac{|x|}{x} \geq 0.$

19. $(1-a)\sqrt{2x+1} < 1.$

20. $\sqrt{x+1} > \sqrt{3-x}.$ 21. $\sqrt{x+2} \geq \sqrt{x-a}.$

22. (a) $\sqrt{24-10x} > 3-4x;$

(b) $x > \sqrt{1-x};$ (c) $x > \sqrt{24-5x};$

(d) $\sqrt{\frac{1}{x^2} - \frac{3}{4}} < \frac{1}{x} - \frac{1}{2};$

(e) $\sqrt{4-\sqrt{1-x}} - \sqrt{2-x} > 0.$

23. (a) $\sqrt{x^2+x-12} < x;$

(b) $1 - \sqrt{13+3x^2} \leq 2x;$

(c) $\sqrt{x^2+x} > 1-2x;$ (d) $4-x < \sqrt{x^2-2x}.$

24. $\sqrt{x+3} > \sqrt{x-1} + \sqrt{x-2}.$

25. (a) $\frac{x-2}{\sqrt{2x-3}-1} < 4;$

(b) $\frac{2-\sqrt{x+3}}{x-1} > -\frac{1}{3};$

(c) $\sqrt{x+2} - \sqrt{5x} > 4x-2;$

(d) $\sqrt{x+1} + 1 < 4x^2 + \sqrt{3x}.$

26. $\frac{\sqrt{24+2x-x^2}}{x} < 1.$
27. $2(x + \sqrt{x^2+4x+3}) < 3(\sqrt{x+1} + \sqrt{x+3} - 2).$
28. At what values of $p \in \mathbb{Z}$ is the function $f(x) = \sqrt[n]{x^p}$ $n \in \mathbb{N}$, even?
29. Is there a constant number T , $T \neq 0$, such that the equality $f(x) = f(x+T)$ is satisfied for the function $f(x) = \sqrt{x-1}$?
30. Find the derivative of the function (derive formulas using the definition of the derivative) (a) $y = \sqrt{x}$; (b) $y = 3\sqrt[3]{x}$; (c) $y = \sqrt[4]{x}$.
31. Find the derivative of the function (a) $y = \sqrt{x} - 1/\sqrt{x}$; (b) $y = x^2\sqrt{x}$; (c) $y = \sqrt{x}(x^3 - \sqrt{x} + 1)$; (d) $y = (1 + \sqrt{x})(1 + \sqrt{2x})(1 + \sqrt{3x})$; (e) $y = (1 + \sqrt{x})/(1 + \sqrt{2x})$; (f) $y = \sqrt{1-x^2}$; (g) $y = (1 - 2x^{1/2})^4$; (h) $y = \sqrt{x + \sqrt{x}}$.
32. At the indicated point $M(x_0; y_0)$, calculate the value of the derivative of the function (a) $y = (x^2 + x + 2)^{3/2}$, $M(1; 8)$; (b) $y = \sqrt{(x+1)/(x-1)}$, $M(2; \sqrt{3})$; (c) $y = \sqrt{(1-x^2)/(1+x^2)}$, $M(0; 1)$.
33. At the indicated point $P(x_0; y_0)$, set up an equation of the tangent to the curve (a) $y(x) = \sqrt{x}$, $P(4; 2)$; (b) $y(x) = x - 2\sqrt{x}$, $P(1; -1)$; (c) $y(x) = 3\sqrt[3]{x^2}$, $P(-8; 12)$; (d) $y(x) = \sqrt{x^3} + 1$, $P(4; 9)$.
34. A tangent is drawn to the graph of the function $y = (x+1)\sqrt{x}$ at the point where the slope is equal to 2; the tangent does not pass through the origin. Find the points at which that tangent cuts the coordinate axes.

35. Find the critical points of the function
 (a) $y = x - 4\sqrt{x} + \sqrt{3}$; (b) $y = \sqrt{|x-1|}$;
 (c) $y = \sqrt{x^2 - 6x + 15}$; (d) $y = \sqrt{x^2 - 6x}$;
 (e) $y = (x-1)\sqrt{x}$; (f) $y = (x+2)\sqrt{x-1}$.
36. Find the intervals of the monotone increase of the function
 (a) $y = \sqrt{x-4}$; (b) $y = \sqrt{x^2 - x + 1}$;
 (c) $y = \sqrt{x^2 + 4x - 3}$; (d) $y = \frac{x-9}{\sqrt{x-3}}$;
 (e) $y = 36x - 3x^2 + 4\sqrt{x^3}$.
37. Find the intervals of the monotone decrease of the function
 (a) $y = \sqrt{5-2x}$; (b) $y = \sqrt{2x-x^2}$;
 (c) $y = \sqrt{2x^2 - x + 1}$;
 (d) $y = \frac{8-x}{\sqrt[3]{x^2} + 2\sqrt[3]{x+4}}$, $x \geq 0$;
 (e) $y = \frac{x^2}{4} - \frac{1}{3}x\sqrt{x} + \frac{3}{2}x - 3\sqrt{x} + 1$.
38. Prove that the inequality $2\sqrt{x} > 3 - 1/x$ is satisfied for all $x \in (1; \infty)$.
39. On the indicated intervals, find the greatest and the least value of the function
 (a) $f(x) = \sqrt{100-x^2}$, $x \in [-6; 8]$;
 (b) $f(x) = x + 2\sqrt{x}$, $x \in [0; 4]$;
 (c) $f(x) = \sqrt[3]{(x^2-2x)^2}$, $x \in [0; 3]$.
40. Find the points of extremum, as well as the greatest and the least value of the function $f(x) = (x-1)^2 \times \sqrt{x^2 - 2x + 3}$ on the interval $[0; 3]$.
41. Investigate the behaviour of the function (a) $y = x\sqrt{2-x^2}$; (b) $y = \sqrt[3]{x^2} - x$ and construct its graph using its derivative.

2.2. Systems of Irrational Equations and Inequalities

Solve the following systems of equations:

$$1. (a) \begin{cases} \frac{7}{\sqrt{x-7}} - \frac{4}{\sqrt{y+6}} = \frac{5}{3}, \\ \frac{5}{\sqrt{x-7}} + \frac{3}{\sqrt{y+6}} = \frac{13}{6}; \end{cases}$$

$$(b) \begin{cases} \frac{4}{\sqrt{x+y} - \sqrt{x-y}} - \frac{1}{\sqrt[4]{x-y} - \sqrt[4]{x+y}} = 1, \\ \frac{?}{\sqrt{x+y} - \sqrt{x-y}} + \frac{4}{\sqrt[4]{x+y} - \sqrt[4]{x-y}} = \frac{9}{4}. \end{cases}$$

$$2. (a) \begin{cases} \sqrt{\frac{x+y}{2x-1}} + 4\sqrt{\frac{2x-1}{x+y}} = 5, \\ x = y + 1; \end{cases}$$

$$(b) \begin{cases} \sqrt{\frac{x-y}{x+y}} + \sqrt{\frac{x+y}{x-y}} = \frac{10}{3}, \\ xy - 2x - 2y = 2. \end{cases}$$

$$3. \begin{cases} x + y + \sqrt{\frac{x+y}{x-y}} = \frac{12}{x-y}, \\ xy = 15. \end{cases}$$

$$4. \begin{cases} y\sqrt{x^2+y^2} - 2ay - 3 = 0, \\ x\sqrt{x^2+y^2} = 2ax. \end{cases}$$

5. At what values of a does the following system of equations possess a unique solution:

$$\begin{cases} \sqrt{y} = 1/\sqrt{x}, \\ y = ax + 1? \end{cases}$$

6. At what values of a is the following system of equations consistent:

$$\begin{cases} \sqrt{x^2+2xy+y^2} + \sqrt{x^2-2xy+y^2} = 4, \\ \sqrt{x^2+y^2} = a? \end{cases}$$

7. Solve the following system of inequalities:

$$\begin{cases} \sqrt{4-3x} \geq x, \\ \sqrt{x} + \sqrt{x-1} < 5. \end{cases}$$

Find the graphical solutions of the following inequalities and systems of inequalities:

8. $\sqrt{x-y} \geq \sqrt{x+y}$. 9. $1 + \sqrt{x} \geq y$.
10.
$$\begin{cases} y - 2 < \sqrt{1 - x^2}, \\ y > 2|x|. \end{cases}$$

2.3. An Exponential and a Logarithmic Function, Exponential and Logarithmic Equations, Systems of Equations, and Inequalities

- Which of the numbers (a) $\left(\frac{2}{3}\right)^{0.6}$; (b) $(1.4)^{0.6}$; (c) $(0.8)^{-\frac{2}{3}}$; (d) $(1.5)^{-0.1}$; (e) $(0.4)^{-0.3}$; (f) $(0.7)^{0.4}$; (g) $(4.8)^{-0.8}$; (h) $(0, (3))^{\sqrt{2}}$; (i) $(\sqrt{3})^{0.43}$; (j) $e^{0.75}$; (k) $(\pi/2)^{\sqrt{2.1}}$; (l) $(\pi/7)^{-\sqrt{3.1}}$ exceed unity?
- Which of the numbers x and y is greater in the inequality (a) $(0.8)^x > (0.8)^y$; (b) $(1.5)^x < (1.5)^y$; (c) $(7.1)^x > (7.1)^y$; (d) $(1/5)^x < (1/5)^y$, $x, y \in \mathbb{R}$?
- Which of the two numbers is greater, 2^{300} or 3^{200} ?
- Simplify the following expressions: (a) $25^{\log_5 3}$; (b) $e^{\ln \ln 3}$; (c) $\ln ab - \ln |b|$; (d) $\log_a b^2 + \log_{a^2} b^4$; (e) $2^{\frac{1}{\log_3 2}}$; (f) $\frac{\log_2 25}{\log_2 5}$; (g) $\log_3 5 \cdot \log_4 9 \cdot \log_5 2$; (h) $\sqrt{\log_{0.5}^2 4}$; (i) $a^{\sqrt{\log_a b}} - b^{\sqrt{\log_b a}}$.
- Find (a) $\log_{30} 8$, if $\log_{30} 3 = c$, $\log_{30} 5 = d$; (b) $\log_9 40$, if $\log 15 = c$, $\log_{20} 50 = d$; (c) $\log (0.175)^4$, if $\log 196 = c$, $\log 56 = d$.
- Prove that if $a = \log_{12} 18$, $b = \log_{24} 54$, then $ab + 5(a - b) = 1$.
- Without resorting to tables, calculate $\frac{\log_2 24}{\log_{36} 2} - \frac{\log_2 192}{\log_{12} 2}$.

8. Prove that

$$\log_n (n + 1) > \log_{n+1} (n + 2),$$

for any natural $n > 1$.

9. Prove (without resort to tables) that $\log_4 9 > \log_9 25$.

Solve the following equations:

10. (a) $3^{x-5} = 7$; (b) $3^{|3x-4|} = 9^{2x-2}$;

(c) $7^{x+2} - \frac{1}{7} \cdot 7^{x+1} - 14 \cdot 7^{x-1} + 2 \cdot 7^x = 48$;

(d) $2^{2x-3} = 4^{x^2-3x-1}$; (e) $32^{\frac{x+5}{x-7}} = 0.25 \cdot 128^{\frac{x+17}{x-3}}$;

(f) $4^{\frac{1}{x}-2} = \frac{\ln \sqrt{e}}{2}$;

(g) $2^{\frac{3}{\log_8 x}} = \frac{1}{64}$;

(h) $\sqrt[3]{3^{-4+\log 5}} \sqrt[5]{x} = \frac{1}{3}$;

(i) $7^{3x} + 9 \cdot 5^{2x} = 5^{2x} + 9 \cdot 7^{3x}$;

(j) $9^x - 2^{x+\frac{1}{2}} = 2^{x+\frac{3}{2}} - 3^{2x-1}$;

(k) $\sqrt[3]{2^x \sqrt[3]{4^x (0.125)^{1/x}}} = 4 \sqrt[3]{2}$;

(l) $4 \sqrt[3]{(0.125)^{x-3}} = 2 \sqrt{x+1}$;

(m) $\left((\sqrt[5]{27})^{\frac{x}{4}} - \sqrt{\frac{x}{3}} \right)^{\frac{x}{4}} + \sqrt{\frac{x}{3}} = \sqrt[4]{3^7}$.

11. (a) $4^{x^2+2} - 9 \cdot 2^{x^2+2} + 8 = 0$;

(b) $9^{x^2-1} - 36 \cdot 3^{x^2-3} + 3 = 0$;

(c) $(\sqrt[5]{3})^x + (\sqrt[10]{3})^{x-10} = 84$;

(d) $4^{x+\sqrt{x^2-2}} - 5 \cdot 2^{x-1+\sqrt{x^2-2}} = 6$.

12. (a) $4^{x+1.5} + 9^x = 6^{x+1}$;

(b) $25^{2x-x^2+1} + 9^{2x-x^2+1} = 34 \cdot 15^{2x-x^2}$;

- (c) $2^{2x^2} + 2^{x^2+2x+2} = 2^{5+4x}$;
 (d) $(\sqrt{5}\sqrt{2}-7)^x + 6(\sqrt{5}\sqrt{2}+7)^x = 7$.
13. (a) $3^{2x^2} - 2 \cdot 3^{x^2+x+6} + 3^{2(x+6)} = 0$;
 (b) $x^2 \cdot 2^{\sqrt{2x+1}-1} + 2^x = 2^{\sqrt{2x+1}+1} + x^2 \cdot 2^{x-2}$.
14. (a) $4^{\log_{64}(x-3) + \log_2 5} = 50$;
 (b) $x^{\log_x(1-x)^2} = 9$.
15. $\log_3(x^2 + 4x + 12) = 2$.
16. (a) $\log_3 x + \log_9 x + \log_{27} x = 5.5$;
 (b) $\log_2(3-x) + \log_2(4-x) = 3$;
 (c) $\log(x-3) + \log(x+6) = \log 2 + \log 5$;
 (d) $\log(x-4) + \log(x+3) = \log(5x+4)$;
 (e) $\ln(x^3+1) - 0.5 \ln(x^2+2x+1) = \ln 3$;
 (f) $\log_5(x-2) + 2 \log_5(x^3-2) + \log_5(x-2)^{-1} = 4$;
 (g) $2 \log_3(x-2) + \log_3(x-4)^2 = 0$;
 (h) $\log_2(x+2)^2 + \log_2(x+10)^2 = 4 \log_2 3$;
 (i) $\log_2 \frac{x-2}{x-1} - 1 = \log_2 \frac{3x-7}{3x-1}$;
 (j) $2 \log_2 \frac{x-7}{x-1} + \log_2 \frac{x-1}{x+1} = 1$;
 (k) $\log_3(5x-2) - 2 \log_3 \sqrt{3x+1} = 1 - \log_3 4$;
 (l) $\log(3x-2) - 2 = \frac{1}{2} \log(x+2) - \log 50$;
 (m) $\log^2\left(1 + \frac{4}{x}\right) + \log^2\left(1 - \frac{4}{x+4}\right) = 2 \log^2\left(\frac{2}{x-1} - 1\right)$.
17. (a) $\log_2 x^4 + \log_a x^2 = 1$;
 (b) $\log_2(x-1) - \log_{\sqrt{2}} \sqrt{x+3} = \log_3(x-a)^3 + \log_{1/2}(x-3)$; (c) $\log_2(6x^2+25x) = 1 + \log_2(ax+4a-2)$.
18. (a) $\log_3 x \log_4 x \log_5 x = \log_3 x \log_4 x + \log_4 x \log_5 x + \log_5 x \log_3 x$; (b) $\left(\log_3 \frac{3}{x}\right) \log_2 x - \log_3 \frac{x^3}{\sqrt{3}} = \frac{1}{2} + \log_2 \sqrt{x}$.

19. (a) $\log(10x^2) \log x = 1$;
- (b) $\frac{\log_2 x - 1}{\log_2 \frac{x}{2}} = 2 \log_2 \sqrt{x} + 3 - \log_2^2 x$;
- (c) $2 \log_9 x + 9 \log_x 3 = 10$;
- (d) $\log_x(125x) \log_{25}^2 x = 1$;
- (e) $\log_x \sqrt{5} + \log_x 5x = \frac{9}{4} + \log_x^2 \sqrt{5}$;
- (f) $\log(\log x) + \log(\log x^3 - 2) = 0$;
- (g) $\log_{3x+7}(9 + 12x + 4x^2) = 4 - \log_{2x+3}(6x^2 + 23x + 21)$;
- (h) $\log^2(4-x) + \log(4-x) \log\left(x + \frac{1}{2}\right) - 2 \log^2\left(x + \frac{1}{2}\right) = 0$.
20. (a) $(x^2 \log_x 27) \log_9 x = x + 4$;
- (b) $\log_x 2 - \log_4 x + 7/6 = 0$;
- (c) $\log_{0.5x} x^2 - 14 \log_{16x} x^3 + 40 \log_{4x} \sqrt{x} = 0$;
- (d) $4 \log_{\frac{x}{2}} \sqrt{x} + 2 \log_{4x} x^2 = 3 \log_{2x} x^3$;
- (e) $\log_{3x}\left(\frac{3}{x}\right) + \log_3^2 x = 1$;
- (f) $(\log_{1/\sqrt{1+x}} 10) \log(x^2 - 3x + 2) = (\log(x-3)) \log_{1/\sqrt{1+x}} 10 - 2$.
21. (a) $\frac{\log_x(2a-x)}{\log_x 2} + \frac{\log_a x}{\log_a 2} = \frac{1}{\log_{a^2-1} 2}$;
- (b) $\frac{\log_{a^2} \sqrt{x}^a}{\log_{2x} a} + (\log_{ax} a) \log_{\frac{1}{a}} 2x = 0$.
22. (a) $\sqrt{1 + \log_{0.04} x} + \sqrt{3 + \log_{0.2} x} = 1$;
- (b) $\sqrt{2 - \log_x 9} = -\frac{\sqrt{12}}{\log_3 x}$;
- (c) $\log_x(x^2 + 1) = \sqrt{\log_{\sqrt{x}}(x^2(1+x^2)) + 4}$;
- (d) $\sqrt{\log_2 x} - 0.5 = \log_2 \sqrt{x}$.

23. (a) $\log(3^x - 2^{4-x}) = 2 + \frac{1}{4} \log 16 - \frac{x}{2} \log 4$;
 (b) $\log_3 \left(\log_9 x + \frac{1}{2} + 9^x \right) = 2x$;
 (c) $\log_3 \left(3^{x^2-13x+28} + \frac{2}{9} \right) = \log_5 0.2$.
24. (a) $\log 2 + \log(4^{x-2} + 9) = 1 + \log(2^{x-2} + 1)$;
 (b) $\log(6 \cdot 5^x + 25 \cdot 20^x) = x + \log 5$.
25. (a) $\log_{\sqrt{5}}(4^x - 6) - \log_5(2^x - 2)^2 = 2$;
 (b) $x(1 - \log 5) = \log(4^x - 12)$;
 (c) $\log_2(4^x + 1) = x + \log_2(2^{x+3} - 6)$;
 (d) $\log_3(9^x + 9) = x - \log_{\frac{1}{3}}(28 - 2 \cdot 3^x)$;
 (e) $\log_2 \left(\frac{8}{2^x} - 1 \right) = x - 2$;
 (f) $\log_{\frac{1}{3}} \left(2 \left(\frac{1}{2} \right)^x - 1 \right) = \log_{\frac{1}{3}} \left(\left(\frac{1}{4} \right)^x - 4 \right)$.
26. (a) $(x+1)^{\log(x+1)} = 100(x+1)$; (b) $x^{\frac{\log x+5}{3}} = 10^{5+\log x}$;
 (c) $3^{\log x} = 54 - x^{\log 3}$; (d) $\log_2(9 - 2^x) = 10^{\log(3-x)}$.
27. $|x-1|^{\log^2 x - \log x^2} = |x-1|^3$.
28. $(3^{x^2-7.2x+3.9} - 9\sqrt{3}) \log(7-x) = 0$.
29. $3 \cdot 2^{\log_x(3x-2)} + 2 \cdot 3^{\log_x(3x-2)} = 5 \cdot 6^{\log_{x^2}(3x-2)}$.
30. It is known that $x=9$ is a root of the equation
- $$\log_{\pi}(x^2 + 15a^2) - \log_{\pi}(a-2) = \log_{\pi} \frac{8ax}{a-2}.$$
- Find the other roots of this equation.**
31. $|1 - \log_{1/5} x| + 2 = |3 - \log_{1/5} x|$.
32. $\log_4(6 + \sqrt{x} - |\sqrt{x} - 2|) = \frac{1}{2} + \log_2 |\sqrt{x} - |\sqrt{x} - 2||$.
33. (a) $5^x + 12^x = 13^x$; (b) $3^x + 4^x + 5^x = 6^x$;
 (c) $2^x = 1 - x$; (d) $\log_2(4-x) = x - 3$.

Solve the following systems of equations:

$$34. \text{ (a) } \begin{cases} 4^{x+y} = 128, \\ 5^{3x-2y-3} = 1; \end{cases} \quad \text{(b) } \begin{cases} \log_{a^2} x - \log_{a^4} y = 3, \\ \log_{a^6} x + \log_{a^8} y = 4; \end{cases}$$

$$\text{(c) } \begin{cases} 2^{x+y-1} + 2^{x-y+1} = 3, \\ \frac{1}{7} \cdot 3^{x \log_3 2 + y \log_3 2 - 2} + 3^{x \log_3 2 - y \log_3 2 - 2} = \frac{1}{7}. \end{cases}$$

$$35. \text{ (a) } \begin{cases} 10^{1+\log(x+y)} = 50, \\ \log(x-y) + \log(x+y) = 2 - \log 5; \end{cases}$$

$$\text{(b) } \begin{cases} x^{\log_x 2} = \log_3(x+y), \\ x^2 + y^2 = 65. \end{cases}$$

$$36. \text{ (a) } \begin{cases} \log_2(x+y) - \log_3(x-y) = 1, \\ x^2 - y^2 = 2; \end{cases}$$

$$\text{(b) } \begin{cases} (3y^2 + 1) \log_3 x = 1, \\ x^{2y^2+10} = 27. \end{cases}$$

$$37. \text{ (a) } \begin{cases} (\log_4 x + \log_4 y = 1 + \log_4 9, \\ x + y = 20; \end{cases}$$

$$\text{(b) } \begin{cases} \log x + \log y = 2, \\ x - y = 15; \end{cases}$$

$$\text{(c) } \begin{cases} \log_3 x + \log_3 y = 2 + \log_3 2, \\ \log_3(x+y) = 2; \end{cases}$$

$$\text{(d) } \begin{cases} 4^{-y} \log_2 x = 4, \\ \log_2 x + 2^{-2y} = 4; \end{cases}$$

$$\text{(e) } \begin{cases} y + \log x = 1, \\ x^y = 0.01; \end{cases} \quad \text{(f) } \begin{cases} x^{\log y} = 2, \\ xy = 20; \end{cases}$$

$$\text{(g) } \begin{cases} 2^x \cdot 8^{-y} = 2\sqrt{2}, \\ \log_9 \frac{1}{x} + 0.5 = \frac{1}{2} \log_3 9y; \end{cases}$$

$$\text{(h) } \begin{cases} (\log_a(xy) - 2) \left(\log_a \frac{4}{9}\right)^{-1} = -1, \\ x + y = 5a. \end{cases}$$

$$\begin{aligned}
38. \quad & \text{(a) } \begin{cases} 2(\log_y x + \log_x y) = 5, \\ xy = 8; \end{cases} \\
& \text{(b) } \begin{cases} \log_x y + \log_y x = 2.5, \\ x + y = a^2 + a. \end{cases} \\
39. \quad & \begin{cases} x^2/y + y^2/x = 28, \\ \log_9 x - \log_{\frac{1}{9}} y = 1.5. \end{cases} \\
40. \quad & \begin{cases} \log_2 y = \log_4 (xy - 2), \\ \log_9 x^2 + \log_3 (x - y) = 1. \end{cases} \\
41. \quad & \begin{cases} 2^{x^2+y} = 4^{(y^2+x)/2}, \\ \sqrt{xy} = 2. \end{cases} \\
42. \quad & \begin{cases} 4^{x/y-3y/x} = 16, \\ \sqrt{x} - \sqrt{2y} = \sqrt{12} - \sqrt{8}. \end{cases} \\
43. \quad & \begin{cases} x + y = 4 + \sqrt{y^2 + 2}, \\ \log x - 2 \log 2 = \log(1 + 0.5y). \end{cases} \\
44. \quad & \begin{cases} \log_3 (\log_2 x) + \log_{\frac{1}{3}} (\log_{\frac{1}{2}} y) = 1, \\ xy^2 = 4. \end{cases} \\
45. \quad & \begin{cases} \frac{1}{3} \sqrt[3]{9} = 9^{x/(2y)}, \\ \frac{x+3y}{x} = \frac{2x}{y} - 4. \end{cases}
\end{aligned}$$

Solve the following inequalities:

$$\begin{aligned}
46. \quad & \text{(a) } \log(x^2 - 2x - 2) \leq 0; \\
& \text{(b) } \log_5(x^2 - 11x + 43) < 2; \\
& \text{(c) } 2 - \log_2(x^2 + 3x) \geq 0; \\
& \text{(d) } \log_{1.5} \frac{2x-8}{x-2} < 0; \\
& \text{(e) } \log_3 \frac{1+2x}{1+x} < 1; \quad \text{(f) } \log_4 \frac{3x+2}{x} \leq 0.5; \\
& \text{(g) } \log_2 \frac{x^2-4x+2}{x+1} \leq 1; \\
& \text{(h) } \log_2^2 \left(\frac{4x-3}{4-3x} \right) > -\frac{1}{2}.
\end{aligned}$$

47. (a) $\log_{\frac{1}{5}}(2x^2 + 5x + 1) < 0$;
 (b) $\log_{\frac{1}{3}}(x^2 + 2x) > 0$;
 (c) $\log_{\frac{1}{4}}(x^2 - 4x + 6) < -2$;
 (d) $\log_{\frac{1}{3}}\frac{3x-1}{x+2} < 1$;
 (e) $\log_{0.25}\frac{35-x^2}{x} \geq -\frac{1}{2}$.
48. (a) $\log_5(2x-4) < \log_5(x+3)$;
 (b) $\log_{0.1}(x^2+x-2) > \log_{0.1}(x+3)$;
 (c) $\log\sqrt{x^2-3x+4} - \log\sqrt{x+1} > 0$;
 (d) $\log_{1/2}(x+1) \leq \log_2(2-x)$;
 (e) $\log_{1/2}\frac{x^2+6x+9}{2(x+1)} < -\log_2(x+1)$.
49. (a) $\log(x-2) + \log(27-x) < 2$;
 (b) $\log(x-1) + \log(x-2) < \log(x+2)$;
 (c) $\log_2(2-x) + \log_{1/2}(x-1) > \log_{\sqrt{2}}3$;
 (d) $\log_{1/5}(2x+5) - \log_{1/5}(16-x^2) \leq 1$;
 (e) $\log_2\left(1 + \frac{1}{x}\right) + \log_{\frac{1}{2}}\left(1 + \frac{x}{4}\right) \geq 1$;
 (f) $\log_7 x - \log_7(2x-5) \leq \log_7 2 - \log_7(x-3)$;
 (g) $\log_{1/3}(x-1) + \log_{1/3}(x+1) + \log_{\sqrt{3}}(5-x) < 1$;
 (h) $\log_2 x^2 + \log_2(x-1)^2 > 2$.
50. (a) $2^x > 5$; (b) $\left(\frac{3}{4}\right)^{6x+10-x^2} < \frac{27}{64}$;
 (c) $(1/2)^{\log_3(x^2-2x-3)} > 1$;
 (d) $3^{\log_3(x^2-3x+2)} > 3$;
 (e) $5^{\log_3\frac{x-2}{x}} < 1$;
 (f) $\left(\frac{1}{3}\right)^{x^2+2x} < \left(\frac{1}{9}\right)^{16-x}$;
 (g) $3^{\sqrt{x}} > 2^a$.

51. (a) $\log^4 x + 3 \log x - 4 \geq 0$; (b) $\frac{1 - \log_4 x}{1 + \log_2 x} \leq \frac{1}{2}$;
- (c) $\log_{1/3} x > \log_x 3 - \frac{5}{2}$;
- (d) $(\log_2 x)^4 - \left(\log_{\frac{1}{2}} \frac{x^5}{4}\right)^2 - 20 \log_2 x + 148 < 0$;
- (e) $(2 \log_3^2 x - 3 \log_3 x - 8)(2 \log_3^2 x - 3 \log_3 x - 6) \geq 3$;
- (f) $(\log_2^2 x + 3 \log_2 x + 1)(\log_2^2 x + 3 \log_2 x - 3) < 5$;
- (g) $(1.25)^{1 - (\log_2 x)^2} < (0.64)^{2 + \log \sqrt{2}^x}$.
52. (a) $2^{2x+1} - 21 \cdot \left(\frac{1}{2}\right)^{2x+3} + 2 \geq 0$;
- (b) $0.1^{x+1} < 0.8 + 2 \cdot 10^x$; (c) $2^x + 2^{-x} < 3$;
- (d) $3^{4-3x} - 35 \cdot 3^{3x-2} + 6 \geq 0$; (e) $\frac{6}{2^x - 1} < 2^x$;
- (f) $3^{\log x + 2} < 3^{\log x^2 + 5} - 2$;
- (g) $\left(\frac{1}{2}\right)^{\log x^2} + 2 > 3 \cdot 2^{-\log(-x)}$.
53. (a) $\log_2(4^x - 5 \cdot 2^x + 2) > 2$;
- (b) $\log_{1/\sqrt{5}}(6^{x+1} - 36^x) \geq -2$;
- (c) $\log_{\sqrt{2}}(5^x - 1) \log_{\sqrt{2}} \frac{2\sqrt{2}}{5^x - 1} > 2$;
- (d) $\log(1 + 2^{x+1}) > \frac{(x \log 2) \log 4}{\log 8} + \log 3$.
54. (a) $\sqrt{\log_2 \frac{3-2x}{1-x}} < 1$;
- (b) $\sqrt{\log_3(9x-3)} \leq \log_3\left(x - \frac{1}{3}\right)$;
- (c) $\sqrt{9^x + 3^x - 2} \geq 9 - 3^x$.
55. (a) $\log_{1/3}(\log_4(x^2 - 5)) > 0$; (b) $0.3^{\frac{\log_1 \log_2 \frac{3x+6}{x^2+2}}{3}} > 1$.
56. (a) $\log_{4/3}(\sqrt{x+3} - x) > 0$;
- (b) $\log_{1/2}(\sqrt{5-x} - x + 1) > -3$.

57. (a) $x^{\log_a x - 2} > \frac{x}{4}$; (b) $x^{(\log x)^2 - 3 \log x + 1} > 1000$;
 (c) $\sqrt{x^{\log_2 \sqrt{x}}} \geq 2$.
58. (a) $\log_a (x-1) + \log_a x > 2$;
 (b) $\frac{1}{5 - \log_a x} + \frac{2}{1 + \log_a x} < 1, 0 < a < 1$;
 (c) $\frac{3 \log_a x + 6}{\log_a^2 x + 2} > 1$;
 (d) $\log_a (1 - 8a^{-x}) \geq 2(1 - x)$.
59. (a) $\log_{x-3} (x-1) < 2$; (b) $\log_x (x+2) > 2$.
60. (a) $\log_{2x} (x^2 - 5x + 6) < 1$; (b) $\log_{x+3} (x^2 - x) < 1$;
 (c) $\log_{3x+5} (9x^2 + 8x + 2) > 2$; (d) $\log_{2x+4} (x^2 + 1) \leq 1$;
 (e) $\log_x \frac{15}{1-2x} < -2$.
61. (a) $\log_{x^2} (3 - 2x) > 1$; (b) $\log_{x^2+3x} (x+3) < 1$.
62. $\log_{\frac{2}{3}|x-2|} 2^{1-x^2} \geq 0$.
63. $\log_{\log_2 (\frac{1}{2}x)} (x^2 - 10x + 22) > 0$.
64. (a) $|x|^{x^2 - x - 2} < 1$; (b) $\left| \log_2 \frac{x}{6} \right|^{x^2 - 18x + 56} > 1$.
65. (a) $\frac{\log_5 (x^2 + 3)}{4x^2 - 16x} < 0$;
 (b) $-\frac{\log_{0.5} (x-1)}{\sqrt{2x - x^2 + 8}} \geq 0$;
 (c) $\frac{\log_{0.5} x + 2}{\sqrt{2x-1}} > 0$; (d) $\frac{3x^2 - 2x - 1}{\log_3 (x-1)} < 0$.
66. (a) $25 \cdot 2^x - 10^x + 5^x > 25$;
 (b) $\log_5 x + \log_x \frac{x}{3} > \frac{(\log_5 x)(2 - \log_3 x)}{\log_3 x}$;
 (c) $\frac{1}{\log_4 \frac{x+1}{x+2}} \leq \frac{1}{\log_4 (x+3)}$.

Solve the following systems of inequalities:

$$67. (a) \begin{cases} \frac{\sqrt{(x-8)(2-x)}}{\log_{0.3} \left(\frac{10}{7} (\log_2 5 - 1) \right)} \geq 0, \\ 2^{x-3} - 31 > 0; \end{cases}$$

$$(b) \begin{cases} \frac{\sqrt{\log_3^2 x - 3 \log_2 x + 2}}{\log_5 \left(\frac{1}{3} (\log_3 5 - 1) \right)} \geq 0, \\ x - \sqrt{x} - 2 \geq 0. \end{cases}$$

$$68. \begin{cases} \left(\frac{1}{81} \right)^{8 + \log_a x} > \left(\frac{1}{3} \right)^{\log_2^2 x} \\ 0 < x < 1. \end{cases}$$

69. Which of the functions given below are even and which are odd?

$$(a) y = 2^{-x^2}; (b) y = \frac{a^x + a^{-x}}{2}; (c) y = \frac{a^x - a^{-x}}{2};$$

$$(d) y = \frac{a^x - a^{-x}}{a^x + a^{-x}}; (e) y = \frac{a^x + 1}{a^x - 1};$$

$$(f) y = x \frac{a^x - 1}{a^x + 1}; (g) y = \ln \frac{1+x}{1-x};$$

$$(h) y = \log_2 (x + \sqrt{x^2 + 1}).$$

70. Represent the function $y = 3^x$ as the sum of an even and an odd function.

71. Given the function $y = (1/2)^{\sin x}$. Find the least positive period of that function. Is the function odd?

72. Find the inverse of the function $y = (e^x - e^{-x})/2$.

Construct the graphs of the following equations:

$$73. y = 3^{-|x|}. \quad 74. y = \log_2 (1 - x).$$

$$75. y = |\log_2 (1 - x)|. \quad 76. y = \log_2 (2 - x)^2.$$

$$77. y = \frac{|\ln x|}{\ln x}. \quad 78. y = x^{\log_x 2}.$$

$$79. y = e^{|\ln x|}. \quad 80. y = \log_2 (x^2 - 2x).$$

$$81. y = \log_2 \left| \frac{x}{x-1} \right|. \quad 82. y = \log_2 \sin x.$$

$$83. |y| = \log_2 (-x).$$

Find the derivatives of the following functions:

84. (a) $y = 3^x$; (b) $y = 10^x$; (c) $y = 1/2^x$; (d) $y = e^x + e^{-x}$;
(e) $y = 2e^x - e^{-x}$; (f) $y = 3^x + 4^x$; (g) $y = x \cdot 10^x$;
(h) $y = xe^x$; (i) $y = x/e^x$; (j) $y = \sqrt{2^x}$;
(k) $y = e^{x^2-5x^2}$; (l) $y = \frac{e^x}{1+x}$.

85. (a) $y = \log_3 x$; (b) $y = \log_2 x + \log_{1/3} x$; (c) $y = \log_5 \sqrt{x}$;
(d) $y = \log_7 x^5$; (e) $y = x + \ln x$;
(f) $y = x \ln x$; (g) $y = \ln^2 x$; (h) $y = \sqrt{\ln x}$;
(i) $y = \frac{1 - \ln x}{1 + \ln x}$; (j) $y = \frac{\ln x}{1 + x^2}$.

86. At the point x_0 , find the value of the derivative of the function (a) $y = 4^x$, $x_0 = 2$; (b) $y = e^{-x}$, $x_0 = \ln 3$;
(c) $y = \ln(x^2 - 4x)$, $x_0 = 5$; (d) $y = x \ln^2 x$, $x_0 = e$.

87. At the indicated point $K(x_0; y_0)$, set up an equation of the tangent to the curve (a) $y = e^x$; $K(0; 1)$;
(b) $y = \ln x$, $K(1; 0)$.

Find the critical points of the following functions:

88. (a) $y = 2^x - x \ln 2 + 1$; (b) $y = e^x (-x^2 + 4x - 1)$;
(c) $y = e^{-x} (x^2 + 5x + 7)$; (d) $y = xe^{x-x^2}$;
(e) $y = e^{-2x} + (6 - 2a)e^{-x} + 6ax + \cot 3$;
(f) $y = (0.2)^{2x} + (2a + 2)\left(\frac{1}{5}\right)^x - (2a \ln 5)x + \ln 3$;
(g) $y = e^{|x|} - 2x + 1$.

89. (a) $y = \ln(4x - x^2)$; (b) $y = \ln^2 x - 6 \ln x + 5$;
(c) $y = 4 \ln 3 - 16 \ln(x^2 + 3x) + 0.5(x^2 + 3x)^2$.

90. Determine the intervals of the monotone increase of the function

$$f(x) = 0.3125 (1/2)^{3x^2-8x} + 5 (\ln 2) (3x^2 - 8x + 1).$$

91. Determine the intervals of the monotone decrease of the function

$$f(x) = x^2 \ln 27 - 6x \ln 27 + (3x^2 - 18x + 24) \times \\ \times \ln(x^2 - 6x + 8).$$

92. Find the intervals of the increase and decrease of the function (a) $y = x - e^x + \tan \frac{\pi}{7}$; (b) $y = \frac{x}{\ln x} - \frac{\ln 3}{3}$; (c) $y = (2^x - 1)(2^x - 2)$.
93. Find the point of extremum of the function (a) $y = (x^2 - 2x) \ln x - \frac{3}{2}x^2 + 4x + 1$; (b) $y = \left(\frac{x^2}{2} - x\right) \ln x - \frac{x^2}{4} + x - 1$.
94. Find the values of a and b for which the function $f(x) = a \ln x + bx^2 + x + 2$ possesses extrema at the points $x_1 = 1$ and $x_2 = 2$.
95. In the indicated intervals, find the greatest and the least value of the function (a) $y = e^{-x}(x^2 + x - 5)$, $x \in [-4; 4]$; (b) $y = \frac{2^x + 2^{-x}}{\ln 2}$, $x \in [-1; 2]$; (c) $y = 2 \cdot 3^{3x} - 4 \cdot 3^{2x} + 2 \cdot 3^x$, $x \in [-1; 1]$; (d) $y = |x^2 + 2x - 3| + 1.5 \ln x$, $x \in [1/2; 4]$.
96. At what value of x does the expression $2^{x^2} - 1 + 2/(2^{x^2} + 2)$ assume the least value?
97. Solve the inequality $f'(x) < g'(x)$, if (a) $f(x) = x + 3 \ln(x - 2)$, $g(x) = x + 5 \ln(x - 1)$; (b) $f(x) = e^{2x} - 3x$, $g(x) = 5(e^x - x + 3)$.
98. Prove that the inequality (a) $e^x > 1 + x$; (b) $x > \ln(1 + x)$ is valid for all $x \in (0; \infty)$.

Investigate the behaviours of the following functions with the aid of their derivatives and construct their graphs:

99. $y = xe^{-x}$. 100. $y = \ln(x^2 + 1)$.

2.4. Transformation of Trigonometric Expressions

- Prove the identity (a) $\sin^6 \alpha + \cos^6 \alpha + 3 \sin^2 \alpha \times \cos^2 \alpha = 1$; (b) $\frac{\sin^2 \alpha - \tan^2 \alpha}{\cos^2 \alpha - \cot^2 \alpha} = \tan^6 \alpha$.
- Knowing that $\sin \alpha + \cos \alpha = a$, find (a) $|\sin \alpha - \cos \alpha|$; (b) $\cos^4 \alpha + \sin^4 \alpha$.
- Given: $\tan \alpha + \cot \alpha = p$. Find: (a) $\tan^2 \alpha + \cot^2 \alpha$; (b) $\tan^3 \alpha + \cot^3 \alpha$.

4. Find: (a) $\sin\left(\frac{\pi}{3} - \alpha\right)$, if $\tan \alpha = -\frac{3}{4}$, $\frac{3\pi}{2} < \alpha < 2\pi$;
 (b) $\cos(70^\circ + \alpha)$, if $\sin(40^\circ + \alpha) = b$, $0^\circ < \alpha < 45^\circ$;
 (c) $\sin(\alpha + \beta - \gamma)$, if $\sin \alpha = 12/13$, $\cos \beta = 8/17$, $\sin \gamma = 4/5$; $0 < \alpha < \pi/2$, $0 < \beta < \pi/2$, $0 < \gamma < \pi/2$;
 (d) $\sin 3\alpha$, $\cos 3\alpha$, $\tan 3\alpha$, if $\cot \alpha = 4/3$, $\pi < \alpha < \frac{3}{2}\pi$.
5. Given: α , β , γ are the angles of a triangle. Prove the equality $\sin \alpha \sin \beta - \cos \gamma = \cos \alpha \cos \beta$.
6. Prove the identity (a) $(\cos \alpha + \sin \alpha)^2 = 1 + \sin^2 \alpha$;
 (b) $1 - \sin \alpha = 2 \sin^2\left(\frac{\pi}{4} - \frac{\alpha}{2}\right)$;
 (c) $\frac{1 - 2 \sin^2 \alpha}{2 \cot\left(\frac{\pi}{4} + \alpha\right) \cos^2\left(\frac{\pi}{4} - \alpha\right)} = 1$;
 (d) $\frac{1 - 2 \sin^2 \beta}{1 + \sin 2\beta} = \frac{1 - \tan \beta}{1 + \tan \beta}$;
 (e) $\tan\left(\frac{\pi}{4} + \alpha\right) = \frac{1 + \sin 2\alpha}{\cos 2\alpha}$;
 (f) $\frac{\cos \alpha + \sin \alpha}{\cos \alpha - \sin \alpha} = \tan 2\alpha + \sec 2\alpha$;
 (g) $\frac{\sin^4 \alpha + 2 \sin \alpha \cos \alpha - \cos^4 \alpha}{\tan 2\alpha - 1} = \cos 2\alpha$;
 (h) $\frac{\sin(\alpha - \beta) \sin(\alpha + \beta)}{1 - \tan^2 \alpha \cot^2 \beta} = -\cos^2 \alpha \sin^2 \beta$;
 (i) $3 - 4 \cos 2\alpha + \cos 4\alpha = 8 \sin^4 \alpha$;
 (j) $\cos^4 \alpha = \frac{1}{8} \cos 4\alpha + \frac{1}{2} \cos 2\alpha + \frac{3}{8}$;
 (k) $\sin^4 \alpha + \cos^4 \alpha = \frac{1}{2} (1 + \cos^2 2\alpha)$;
 (l) $4 (\sin^6 \alpha + \cos^6 \alpha) = 1 + 3 \cos^2 2\alpha$;
 (m) $8 \left(\sin^8 \frac{\alpha}{2} + \cos^8 \frac{\alpha}{2} \right) = 1 + 6 \cos^2 \alpha + \cos^4 \alpha$.
7. Simplify the expression (a) $\frac{\sin \alpha + \sin 3\alpha}{\cos \alpha + \cos 3\alpha}$;
 (b) $\frac{\cos 4\alpha - \cos 2\alpha}{\sin 2\alpha + \sin 4\alpha}$; (c) $\frac{\sin \alpha - 3 \sin 2\alpha + \sin 3\alpha}{\cos \alpha - 3 \cos 2\alpha + \cos 3\alpha}$;
 (d) $\frac{2(\sin 2\alpha + 2 \cos^2 \alpha - 1)}{\cos \alpha - \sin \alpha - \cos 3\alpha + \sin 3\alpha}$;

- (e) $\cos \frac{2\pi}{7} + \cos \frac{4\pi}{7} + \cos \frac{6\pi}{7}$;
 (f) $\cos 0 + \cos \frac{\pi}{7} + \cos \frac{2\pi}{7} + \dots + \cos \frac{6\pi}{7}$.

8. Prove the identity

- (a) $\frac{2 \sin 2\alpha + \sin 4\alpha}{2(\cos \alpha + \cos 3\alpha)} = \tan 2\alpha \cos \alpha$;
 (b) $\cos^4 \alpha - \sin^4 \alpha + \sin 2\alpha = \sqrt{2} \cos \left(2\alpha - \frac{\pi}{4} \right)$;
 (c) $\cos^2 \alpha + \cos^2 \left(\frac{\pi}{3} + \alpha \right) + \cos^2 \left(\frac{\pi}{3} - \alpha \right) = \frac{3}{2}$;
 (d) $\sin^2 \alpha + \cos \left(\frac{\pi}{3} - \alpha \right) \cos \left(\frac{\pi}{3} + \alpha \right) = \frac{1}{4}$;
 (e) $\log_{1/3} [\cos^2 (\alpha + \beta) + \cos^2 (\alpha - \beta) - \cos 2\alpha \cos 2\beta] = 0$;
 (f) $\frac{\cot^2 2\alpha - 1}{2 \cot 2\alpha} - \cos 8\alpha \cot 4\alpha = \sin 8\alpha$;
 (g) $16 \sin 10^\circ \sin 30^\circ \sin 50^\circ \sin 70^\circ = 1$;
 (h) $\sin^2 \alpha \cos^4 \alpha = \frac{1}{16} + \frac{1}{32} \cos 2\alpha - \frac{1}{16} \cos 4\alpha - \frac{1}{32} \cos 6\alpha$;
 (i) $\sin 9\alpha + 3 \sin 7\alpha + 3 \sin 5\alpha + \sin 3\alpha = 8 \sin 6\alpha \cos^3 \alpha$;
 (j) $\tan (\alpha - \beta) + \tan (\beta - \gamma) + \tan (\gamma - \alpha) =$
 $= \tan (\alpha - \beta) \tan (\beta - \gamma) \tan (\gamma - \alpha)$;
 (k) $\sqrt{1 + \sin \alpha} - \sqrt{1 - \sin \alpha} = 2 \sin \frac{\alpha}{2}$; if $\alpha \in \left[0; \frac{\pi}{2} \right]$.

9. Given : $\sin \alpha + \cos \alpha = 1.4$, $0 < \alpha < \frac{\pi}{4}$. Find $\tan \frac{\alpha}{2}$.

10. The positive acute angles α , β , γ satisfy the relations
 $\tan \frac{\beta}{2} = \frac{1}{3} \cot \frac{\alpha}{2}$, $\cot \frac{\gamma}{2} = \frac{1}{2} \left(3 \tan \frac{\alpha}{2} + \cot \frac{\alpha}{2} \right)$. Find
 the sum $\alpha + \beta + \gamma$.

11. Calculate without using tables: (a) $\cos 292^\circ 30'$;

(b) $\operatorname{cosec} 10^\circ - \sqrt{3} \sec 10^\circ$; (c) $\frac{2 \cos 40^\circ - \cos 20^\circ}{\sin 20^\circ}$;

(d) $-2 \sqrt{2} \sin 10^\circ \left(2 \sin 35^\circ - \frac{\sec 5^\circ}{2} - \frac{\cos 40^\circ}{\sin 5^\circ} \right)$;

(e) $\cos^2 73^\circ + \cos^2 47^\circ + \cos 73^\circ \cos 47^\circ$;

- (f) $\sin 6^\circ - \sin 42^\circ - \sin 66^\circ + \sin 78^\circ$;
 (g) $\frac{\cos^2 33^\circ - \cos^2 57^\circ}{\sin 21^\circ - \cos 21^\circ}$; (h) $6 \cos 40^\circ - 8 \cos^3 40^\circ$;
 (i) $\tan^6 20^\circ - 33 \tan^4 20^\circ + 27 \tan^2 20^\circ - 3$;
 (j) $\cot^2 36^\circ \cot^2 72^\circ$.

12. Excluding α from the relations, find the relationship between x and y :

$$(a) \begin{cases} x = 3 \cos \alpha, \\ y = 4 \sin \alpha, \end{cases} \quad (b) \begin{cases} x^2 - 2 = -2 \cos \alpha, \\ y = 4 \cos^2 \frac{\alpha}{2}; \end{cases}$$

$$(c) \begin{cases} \sqrt{x} = \tan \alpha, \\ \sqrt{y} = \sec \alpha; \end{cases} \quad (d) \begin{cases} x = \sqrt{1 - \sin \alpha}, \\ y = \sin \frac{\alpha}{2} + \cos \frac{\alpha}{2}. \end{cases}$$

2.5. Trigonometric Functions

1. Find the domain of definition of the function (a) $y = \frac{1}{3} \tan 2x$; (b) $y = 5 \cot \frac{x}{3}$; (c) $y = \frac{4}{\cos x}$; (d) $y = -\frac{1}{\sin x}$.
2. Find the range of the function (a) $y = 2 \sin \frac{x}{3} + 1$;
 (b) $y = 5 \cos x \sqrt{2} + 3$; (c) $y = 4 \tan x \cos x$;
 (d) $y = 9 \cos 3x - 12 \cos^3 3x$; (e) $y = \cos^4 \frac{x}{5} - \sin^4 \frac{x}{5}$;
 (f) $y = \tan^2 \left(x - \frac{\pi}{4} \right)$; (g) $y = \sin \sqrt{x}$;
 (h) $y = \cos \left(1 - \frac{1}{x^2 + 1} \right)$; (i) $y = \cos (2 \sin x)$;
 (j) $y = \sin (\log_2 x)$; (k) $y = \cos 2x - \sin 2x$;
 (l) $y = 12 \sin x + 5 \cos x + 1$.
3. Find the greatest and the least value of the function
 (a) $y = a \cos x + b \sin x + c$; (b) $y = 10 \cos^2 x - 6 \sin x \cos x + 2 \sin^2 x$.
4. Find the range of the function $y = \frac{1}{\cos x} + \frac{1}{\sin x}$ defined on the set $X = (0; \pi/2)$, $x \in \mathbb{X}$.

5. Find the least value of the function

$$y = 2(1 + \sin 3x \sin 2x) - \frac{1}{2}(\cos 4x + \cos 6x).$$

6. Prove the function

$$y = \sin 5x + \sin 3x + 5 \sin x \cos 2x, \quad x \in \mathbb{R}$$

is odd.

7. Prove that the function

$$y = \cos 4x + \sin^3 \frac{x}{2} \sin x + 5x^2, \quad x \in \mathbb{R}$$

is even.

8. Find the least positive period of the function

(a) $y = \sin 3x$; (b) $y = \tan 2x + 2 \sin 3x$; (c) $y = \cos \frac{x}{2}$;

(d) $y = \cos^2 x$; (e) $y = \sin(\cos x)$; (f) $y = \cos(\sin x)$

(g) $y = \cos \frac{3}{5}x - \sin \frac{2}{7}x$.

9. Prove that the function $y = \sin \sqrt{x}$ is not periodic.

10. At what values of $n \in \mathbb{Z}$ does the function $y = \sin nx / \sin \frac{x}{n}$ possess the number 4π as its period?

11. With the only use of the definition of an increasing function prove that the function $y = \sin x$ increases on the interval $(0; \frac{\pi}{2})$.

Construct the graphs of the following functions:

12. (a) $y = \sin 2x$; (b) $y = -\sin \frac{x}{3}$; (c) $y = \sin(x - \frac{\pi}{3})$;

(d) $y = \sin |x|$; (e) $y = |\sin x|$; (f) $y = \frac{|\sin x|}{\sin x}$;

(g) $y = x + \sin x$; (h) $y = x \sin x$; (i) $y = \operatorname{cosec} |x|$;

(j) $y = 2^{\sin x}$; (k) $y = \sin[\arcsin(\log_{1/2} x)]$.

13. (a) $y = \cos(-\frac{x}{2})$; (b) $y = \cos 2x$;

(c) $y = \cos(x + \frac{\pi}{4})$; (d) $y = |\cos x|$; (e) $y = \sec x$.

14. (a) $y = \tan 3x$; (b) $y = -\tan \frac{x}{2}$;
 (c) $y = \tan \left(\frac{\pi}{6} - x \right)$; (d) $y = \tan |x|$;
 (e) $y = |\tan x|$; (f) $y = \tan x \cot x$.
15. Construct the graph of the equation (a) $|y| = \sin x$;
 (b) $\sin y = \sin x$.
16. Find the derivative of the function (a) $y = \sin x - \cos x$;
 (b) $y = \tan x + \cot x$; (c) $y = \sin^2 x$; (d) $y = \cos^2 x$;
 (e) $y = \frac{1}{3} \tan^3 x$; (f) $y = \frac{1}{4} \cot^4 x$; (g) $y = \sin 3x$;
 (h) $y = \cos \frac{x}{\sqrt{2}}$; (i) $y = \sin^2(2x - 1)$; (j) $y = \cos^3(x^2 + x)$;
 (k) $y = \frac{\sin x}{1 + \cos x}$.
17. At the indicated point x_0 , find the value of the derivative of the function (a) $y = \sin x$, $x_0 = \pi/6$;
 (b) $y = \cos(-2x)$, $x_0 = \pi/4$; (c) $y = \tan x - x$, $x_0 = \pi/3$.
18. At the indicated point $A(x_0; y_0)$, set up an equation of the tangent to the curve (a) $y = 2 \sin \frac{x}{3}$,
 $A\left(\frac{3}{2}\pi; 2\right)$; (b) $y = \cos^2 x$, $A\left(\frac{\pi}{4}; \frac{1}{2}\right)$;
 (c) $y = \tan 2x$, $A\left(\frac{\pi}{8}; 1\right)$.
19. Find the greatest and the least value of the function

$$y = \sin^2 x - 20 \cos x + 1.$$

20. Prove that the function

$$f(x) = \cos^2 x + \cos^2 \left(\frac{\pi}{3} + x \right) - \cos x \cos \left(\frac{\pi}{3} + x \right)$$

is a constant, i.e. that it does not depend on x . Find the value of that constant.

2.6. Inverse Trigonometric Functions

Find the domains of definition of the following functions:

- (a) $y = \arcsin(1 - x)$; (b) $y = \arccos\left(2 - \frac{x}{2}\right)$;
(c) $y = \arcsin(2x + x^2)$; (d) $y = \arccos \frac{2x}{1+x^2}$;
(e) $y = \arcsin(\cos x)$; (f) $y = \arccos(\sin^2 x)$.
- (a) $y = \arctan(1 - x^2)$; (b) $y = \operatorname{arccot} \sqrt{x}$;
(c) $y = \arctan(\log_2 x)$; (d) $y = \operatorname{arccot}(e^x + e^{-x})$.
- Find the range of the function (a) $y = \arcsin \sqrt{x}$;
(b) $y = \arccos\left(-\frac{1}{\sqrt{x}}\right)$; (c) $y = \arctan \frac{1}{x^2}$;
(d) $y = \operatorname{arccot}(2x - x^2)$.
- Prove the identity (a) $\sin(\arcsin |x|) = |x|$;
(b) $\cos(\arcsin x) = \sqrt{1 - x^2}$; (c) $\tan(\arcsin x) = x/\sqrt{1 - x^2}$, $x \in (-1; 1)$.
- Calculate (a) $\sin\left(2 \arcsin \frac{1}{3}\right)$; (b) $\cos\left(2 \arcsin \frac{1}{3}\right)$;
(c) $\tan\left(2 \arcsin \frac{1}{3}\right)$; (d) $\sin\left(3 \arcsin \frac{1}{3}\right)$;
(e) $\sin\left(\frac{1}{4} \arcsin \frac{\sqrt{63}}{8}\right)$.
- Prove the identity (a) $\cos|\arccos x| = x$;
(b) $\sin(\arccos x) = \sqrt{1 - x^2}$; (c) $\tan(\arccos x) = \sqrt{1 - x^2}/x$, $x \in [-1; 0) \cup (0; 1)$.
- Calculate (a) $\cos\left(3 \arccos \frac{1}{4}\right)$; (b) $\sin\left(\frac{1}{2} \arccos \frac{1}{9}\right)$;
(c) $\sin\left(\frac{1}{4} \arccos \frac{17}{32}\right)$.
- Prove the identity (a) $\tan|\arctan x| = |x|$;
(b) $\cos(\arctan x) = 1/\sqrt{1 + x^2}$;
(c) $\sin(\arctan x) = x/\sqrt{1 + x^2}$.

9. Calculate (a) $\sin (2 \arctan 3)$; (b) $\tan (2 \arctan 3)$;
(c) $\sin \left(\frac{1}{2} \arctan 3 \right)$; (d) $\cos \left(\frac{1}{2} \arctan 5 \right)$;
(e) $\cos \left(\frac{1}{4} \arctan \frac{24}{7} \right)$.
10. Prove the identity (a) $\cot |\operatorname{arccot} x| = x$;
(b) $\tan (\operatorname{arccot} x) = 1/x, x \neq 0$;
(c) $\sin (\operatorname{arccot} x) = 1/\sqrt{1+x^2}$;
(d) $\cos (\operatorname{arccot} x) = x/\sqrt{1+x^2}$.
11. Prove that (a) $\arcsin x = \arccos \sqrt{1-x^2}$ and $\arccos x =$
 $= \arcsin \sqrt{1-x^2}$ for $0 \leq x \leq 1$; (b) $\arcsin x =$
 $= \arctan \frac{x}{\sqrt{1-x^2}}$ and $\arccos x = \operatorname{arccot} \frac{x}{\sqrt{1-x^2}}$ for
 $0 \leq x < 1$; (c) $\arcsin x = \operatorname{arccot} \frac{\sqrt{1-x^2}}{x}$ and $\arccos x =$
 $= \arctan \frac{\sqrt{1-x^2}}{x}$ for $0 < x \leq 1$; (d) $\arctan x =$
 $= \operatorname{arccot} \frac{1}{x} = \arcsin \frac{x}{\sqrt{1+x^2}} = \arccos \frac{1}{\sqrt{1+x^2}}$ and
 $\operatorname{arccot} x = \arctan \frac{1}{x} = \arcsin \frac{1}{\sqrt{1+x^2}} = \arccos \frac{1}{\sqrt{1+x^2}}$
for $x > 0$.
12. Express (a) $\arcsin \frac{3}{5}$; (b) $\arccos \frac{12}{13}$; (c) $\arctan \frac{5}{12}$;
(d) $\operatorname{arccot} \frac{3}{4}$ in terms of all inverse trigonometric func-
tions.
13. Prove that (a) $\arcsin (-x) = -\arcsin x, x \in [-1; 1]$;
(b) $\arctan (-x) = -\arctan x$; (c) $\arccos (-x) = \pi -$
 $-\arccos x, x \in [-1; 1]$; (d) $\operatorname{arccot} (-x) = \pi - \operatorname{arccot} x$.
14. Express (a) $\arccos \left(-\frac{1}{3} \right)$; (b) $\arctan \left(-\frac{7}{24} \right)$;
(c) $\operatorname{arccot} \left(-\frac{7}{24} \right)$ in terms of all inverse trigonomet-
ric functions.
15. Prove that if $x \in [0; 1]$ and $y \in [0; 1]$, then
(a) $\arcsin x + \arcsin y = \arccos (\sqrt{1-x^2} \sqrt{1-y^2} - xy)$;
(b) $\arccos x + \arccos y = \arccos (xy - \sqrt{1-x^2} \sqrt{1-y^2})$;

- (c) $\arcsin x - \arcsin y = \arcsin (x\sqrt{1-y^2} - y\sqrt{1-x^2})$;
 (d) $\arccos x - \arccos y = \arcsin (y\sqrt{1-x^2} - x\sqrt{1-y^2})$;
 (e) $\arctan x + \arctan y = \operatorname{arccot} \frac{1-xy}{x+y}$, $x > 0$, $y > 0$;
 (f) $\arctan x - \arctan y = \arctan \frac{x-y}{1+xy}$, $x > 0$, $y > 0$;
 (g) $\operatorname{arccot} x - \operatorname{arccot} y = \arctan \frac{y-x}{1+xy}$, $x > 0$, $y > 0$;
 (h) $\operatorname{arccot} x + \operatorname{arccot} y = \operatorname{arccot} \frac{xy-1}{x+y}$, $x > 0$, $y > 0$.

16. Perform the indicated operations:

- (a) $\arcsin \frac{3}{5} + \arcsin \frac{12}{13}$; (b) $\arccos \frac{7}{25} + \arccos \frac{3}{5}$;
 (c) $\arctan 4 + \arctan 5$; (d) $\arcsin \frac{3}{5} - \arcsin \frac{24}{25}$;
 (e) $\arccos \frac{5}{13} - \arccos \frac{7}{25}$; (f) $\arctan 4 - \arctan 5$;
 (g) $\operatorname{arccot} 5 - \operatorname{arccot} 4$.

17. Prove that (a) $\arcsin x + \arccos x = \pi/2$, $x \in [-1; 1]$;
 (b) $\arctan x + \operatorname{arccot} x = \pi/2$.

18. Solve the equation (a) $4 \arcsin x + \arccos x = \pi$;
 (b) $5 \arctan x + 3 \operatorname{arccot} x + 2\pi$; (c) $\arctan x + \arctan 2x + \arctan 3x = \pi$.

19. Find the integral values of k at which the system of equations

$$\begin{cases} \arccos x + (\arcsin y)^2 = k \frac{\pi^2}{4}, \\ (\arcsin y)^2 \arccos x = \pi^4/16 \end{cases}$$

possesses solutions and find those solutions.

20. Find the greatest and the least value of the function

$$f(x) = (\arcsin x)^3 + (\arccos x)^3.$$

21. Calculate (a) $\arcsin \left(\sin \frac{10}{7} \pi \right)$;

(b) $\arccos \left(\sin \left(-\frac{\pi}{9} \right) \right)$; (c) $\arcsin \left(\cos \frac{33}{10} \pi \right)$.

Construct the graphs of the following functions:

22. (a) $y = \arcsin (x-2)$; (b) $y = \arccos \left(\frac{x}{2} \right)$;

(c) $y = \arcsin x^2$; (d) $y = -\arccos (-x^2)$.

23. (a) $y = \arctan(x + 1)$; (b) $y = \operatorname{arccot}(3 - x)$;
(c) $y = \arctan(x^2 - 1)$; (d) $y = \operatorname{arccot}(4 - x^2)$.
24. (a) $y = \sin(\arcsin x)$; (b) $y = \cos(\arcsin x)$;
(c) $y = \arcsin(\sin x)$.
25. Using the formula for seeking the derivative of an inverse function, prove that
(a) $(\arcsin x)' = 1/\sqrt{1-x^2}$, $x \in (-1; 1)$;
(b) $(\arccos x)' = -1/\sqrt{1-x^2}$, $x \in (-1; 1)$;
(c) $(\arctan x)' = 1/(1+x^2)$; (d) $(\operatorname{arccot} x)' = -1/(1+x^2)$.
26. Find the derivative of the function
(a) $y = \arcsin(1-x)$; (b) $y = \arccos(x+2)$;
(c) $y = \arcsin \frac{x}{2} + \arccos 2x$; (d) $y = x \arcsin x$;
(e) $y = \frac{\arccos x}{x}$; (f) $y = \frac{\arcsin x}{\arccos x}$;
(g) $y = \arctan x^2$; (h) $y = \operatorname{arccot} 2^x$;
(i) $y = \arcsin(\sin x)$; (j) $y = \arcsin \sqrt{\frac{1-x}{1+x}}$.
27. At the indicated point x_0 , find the value of the derivative of the function (a) $y = 2 \arcsin x$, $x_0 = \sqrt{3}/2$;
(b) $y = -3 \arccos x$, $x_0 = -\sqrt{2}/2$; (c) $y = \arctan x^3$, $x_0 = 1$; (d) $y = 2 \operatorname{arccot}(x^2 - 3)$, $x_0 = -1$.
28. At the indicated point $B(x_0; y_0)$, derive an equation of the tangent to the curve
(a) $y = \arcsin 3x$, $B\left(\frac{1}{5}; \arcsin \frac{3}{5}\right)$;
(b) $y = \arctan \frac{x}{2}$, $B\left(-2; -\frac{\pi}{4}\right)$.
29. Find the critical points of the function (a) $y = x + \arccos x + 1$; (b) $y = x \arctan x$.
30. Find the greatest and the least value of the function $y = \arctan \frac{1-x}{1+x}$ on the interval $[0; 1]$.

2.7. Trigonometric Equations and Systems of Equations

Solve the following equations:

1. (a) $\sin x = -\frac{1}{2}$; (b) $\sin\left(2x + \frac{\pi}{4}\right) = 1$;
(c) $2 \sin x \cos x - 3 \sin 2x = 0$;
(d) $\sin \frac{x}{2} \cos \frac{\pi}{3} - \cos \frac{x}{2} \sin \frac{\pi}{3} = \frac{1}{4}$;
(e) $\sin \sqrt{x} = -1$.
 2. (a) $\cos x = 0$; (b) $\cos\left(3x - \frac{\pi}{6}\right) = -1$;
(c) $\sin^4 \frac{x}{2} - \cos^4 \frac{x}{2} = \frac{1}{2}$;
(d) $\cos \frac{\pi}{6} \cos x - \sin \frac{\pi}{6} \sin x = \frac{\pi}{4}$;
(e) $\cos x^2 = 1$.
 3. $2 \cos \left[\frac{\pi}{6} \left(\sin x - 13 + \frac{\sqrt{2}}{2} \right) \right] = \sqrt{3}$.
 4. Find all values of the parameter a for which the equation $\cos x = (a - 1.5)/(2 - 0.5a)$ has a solution.
 5. Find the critical points of the function (a) $y = 3 \sin x + 2(x - 1)$; (b) $y = \cos 2x + ax - \sqrt{3}$.
- Solve the following equations:
6. (a) $\tan x = \frac{1}{\sqrt{3}}$; (b) $\tan\left(\frac{x}{2} - \frac{\pi}{7}\right) = -1$; (c) $\frac{2 \tan x}{1 - \tan^2 x} = 5$; (d) $\frac{\tan \frac{\pi}{4} - \tan x}{1 + \tan x \tan \frac{\pi}{4}} = \sqrt{3}$.
 7. (a) $\cot x = 1$; (b) $\cot\left(2x + \frac{\pi}{3}\right) = 2$; (c) $\cot\left(\frac{x}{2} - 3\right) = -1$; (d) $\frac{1}{\tan x} = \sqrt{7} - \sqrt{2}$.
 8. (a) $\cos(1.5\pi + x) = \sqrt{2} \sin(x + \pi) \cos x$;
(b) $2 \sin x \cos x + \sqrt{3} - 2 \cos x - \sqrt{3} \sin x = 0$;
(c) $\sin 2x = (\cos x - \sin x)^2$;

- (d) $\tan^3 3x - 2 \sin^3 3x = 0$;
 (e) $2 \tan x \cos x + 1 = 2 \cos x + \tan x$.
9. (a) $\sin x + \cos^2 x = 1/4$; (b) $3 \cos x = 2 \sin^2 x$;
 (c) $6 \cos^2 x + 13 \sin x = 12$;
 (d) $3 \cos^2 x - 4 \cos x - \sin^2 x - 2 = 0$;
 (e) $\cos^4 \frac{x}{5} + \sin^2 \frac{x}{5} = 1$;
 (f) $\sin x - \frac{|2 \cos x - 1|}{2 \cos x - 1} \sin^2 x = \sin^2 x$.
10. (a) $\tan^2 x - 4 \tan x + 3 = 0$;
 (b) $2 \tan x - 2 \cot x = 3$; (c) $\frac{\sqrt{3}}{\cos^2 x} = 4 \tan x$;
 (d) $\frac{1}{\sin^2 x} = \cot x + 3$.
11. (a) $2 \cos x (\cos x - \sqrt{8} \tan x) = 5$;
 (b) $\left(\cos \frac{\pi}{4} - \sin \frac{\pi}{6}\right) (\sec x + \tan x) = \sin \frac{\pi}{4} \cos x$;
 (c) $\log_2 (3 \sin x) - \log_2 \cos x - \log_2 (1 - \tan x) - \log_2 (1 + \tan x) = 1$.
12. (a) $\sin^4 2x + \cos^4 2x = \sin 2x \cos 2x$;
 (b) $\sin^4 x + \cos^4 x - 2 \sin 2x + \frac{3}{4} \sin^2 2x = 0$;
 (c) $\sin^4 x + \cos^4 x + \sin 2x + a = 0$;
 (d) $\frac{1}{\sin^2 x \cos^2 x} + \frac{2}{\sin x \cos x} - 4 = 0$;
 (e) $\tan 5x + 2 \sin 10x = 5 \sin 5x$.
13. (a) $\cos 2x - 3 \sin x + 2 = 0$;
 (b) $\cos (10x + 12) + 4 \sqrt{2} \sin (5x + 6) = 4$;
 (c) $6 \sin^2 x + 2 \sin^2 2x = 5$; (d) $a \sin^2 x + \cos x = 0$.
14. Find the critical points of the function
 (a) $f(x) = e^3 - \sqrt{4x^2 - 12x + 9} - 4 \sin^2 \frac{x}{2}$;
 (b) $f(x) = \sin^2 3x + 3 \sqrt{x^2 - 4x + 4} + \cos 1$;
 (c) $f(x) = 2x - 0.25 \sin 4x + 0.5 \sin 2x$;

$$(d) f(x) = \log_2 3 + x(1 - \sqrt{10}) + (\sqrt{2} - 2\sqrt{5} + \cos x) \sin x;$$

$$(e) f(x) = (2\sqrt{2} - 1)(1 + \cos x) - \frac{\sqrt{2}}{4} \sin 2x + \left(\frac{1}{\sqrt{2}} - 2\right)x.$$

Solve the following equations:

15. (a) $\cos^3 x + \cos^2 x - 4 \cos^2 \frac{x}{2} = 0;$

(b) $4 \cos x (2 - 3 \sin^2 x) = -(1 + \cos 2x);$

(c) $\tan^3 x - 1 + \frac{1}{\cos^2 x} - 3 \cot \left(\frac{\pi}{2} - x\right) = 3;$

(d) $8 \cos^4 x - 8 \cos^2 x - \cos x + 1 = 0.$

16. (a) $\sin x = 5 \cos x;$ (b) $\sin x - \cos x = 0;$

(c) $\sin x + \cos x = 0;$ (d) $|\sin x| = \sin x + 2 \cos x;$

(e) $\cos^2 x - 4 \sin x \cos x = 0.$

17. (a) $\sin x + \sin 2x = \cos x + 2 \cos^2 x;$

(b) $\sin 2x - \sin^2 x = 2 \sin x - 4 \cos x;$

(c) $\tan x + \sin(\pi + x) = 2 \sin^2 \frac{x}{2};$

(d) $(1 + \sin 2x)(\cos x - \sin x) = \cos x + \sin x;$

(e) $3(\cos x - \sin x) = 1 + \cos 2x - \sin 2x.$

18. (a) $\sin^2 x + 3 \sin x \cos x + 2 \cos^2 x = 0;$

(b) $2 \cos^2 x + 3 \sin 2x - 8 \sin^2 x = 0;$

(c) $3 \sin^2 x + 5 \cos^2 x - 2 \cos 2x - 4 \sin 2x = 0;$

(d) $2 \sin^2 x - 5 \sin x \cos x - 8 \cos^2 x = -2;$

(e) $1/\cos x = 4 \sin x + 6 \cos x.$

19. (a) $\sin^3 x + 4 \cos^3 x = 0;$

(b) $\sin^2 x (1 + \tan x) = 3 \sin x (\cos x - \sin x) + 3;$

(c) $\sin^4 x + \sin^3 x \cos x + \sin^2 x \cos^2 x + \sin x \cos^3 x + \cos^4 x = 1;$

(d) $(8a^2 + 1) \sin^3 x - (4a^2 + 1) \sin x + 2a \cos^3 x = 0.$

20. Find the critical points of the function

- (a) $y = 3 \cos 2x - 5 \sin 2x + 4 \cos 2$;
- (b) $y = 8 \sin 2x + 6 \cos^2 x + 17x + 1$;
- (c) $y = \cos^3 x - 3 \cos x + 3x/8 - 3 \sin 3$;
- (d) $y = 8 (\cos 2 - \cos x) - \sin x - 1/\sin x$;
- (e) $y = 9 \cot x - \cot^3 x + \tan 2$.

Solve the following equations:

21. (a) $\frac{\sqrt{3}}{2} \cos x + \frac{1}{2} \sin x = \frac{\sqrt{3}}{2}$;
- (b) $\sqrt{3} \sin x + \cos x = \sqrt{2}$;
- (c) $\sin 5x = \sqrt{3}(1 + \cos 5x)$; (d) $\cos x + \sin x = 1$;
- (e) $\sin x + \cos x \cot \frac{x}{2} = -\sqrt{3}$;
- (f) $\sin |x| \tan 5x = \cos x$; (g) $\cos x - \sin x = a$;
- (h) $(\sin 2x + \sqrt{3} \cos 2x)^2 - 5 = \cos \left(\frac{\pi}{6} - 2x \right)$;
- (i) $\cos 6x + \tan^2 x + \cos 6x \tan^2 x = 1$.
22. (a) $\frac{\tan 2x + \tan x}{1 - \tan 2x \tan x} = -1$;
- (b) $\frac{\tan 3x - \tan 2x}{1 + \tan 3x \tan 2x} = 1$;
- (c) $2 \tan 3x - 3 \tan 2x = \tan^2 2x \tan 3x$;
- (d) $\cot x + \cot 15^\circ + \cot (x + 25^\circ) =$
 $= \cot 15^\circ \cot x \cot (x + 25^\circ)$.
23. (a) $\sin x + \tan \frac{x}{2} = 0$; (b) $1 + \cos x + \tan \frac{x}{2} = 0$;
- (c) $\tan 2x + \cot x = 4 \sin 2x$;
- (d) $15 \cot \frac{x}{2} + 130 \sin x = \frac{53}{5} \tan \frac{x}{2}$;
- (e) $\frac{59}{4} \cos x + 6 \sin x \tan \frac{x}{2} = 4 \tan x \cot \frac{x}{2}$;
- (f) $2 \sin^2 \left(x - \frac{\pi}{4} \right) = 2 \sin^2 x - \tan x$.

24. Are the equations

$$1 + \cos 2x + \sin 2x = 0 \quad \text{and} \quad 1 + \frac{1 - \tan^2 x}{1 + \tan^2 x} + \frac{2 \tan x}{1 + \tan^2 x} = 0$$

equivalent?

Solve the following equations:

25. (a) $\cos 3x = -2 \cos x$; (b) $\cos 9x - 2 \cos 6x = 2$;
(c) $\cos 4x = \cos^2 3x$.

26. (a) $3 \sin \frac{x}{3} = \sin x$; (b) $\sin 6x + 2 = 2 \cos 4x$;

(c) $\sin \frac{3}{2} x + 3 \sin x = 3 \sin \frac{x}{2}$;

(d) $\sin \left(\frac{\pi}{4} + \frac{3}{2} x \right) = 2 \sin \left(\frac{3\pi}{4} + \frac{x}{2} \right)$.

27. $3 \cos x + 3 \sin x + \sin 3x - \cos 3x = 0$.

28. (a) $\sin x + \sin \frac{3}{2} x = a \sin \frac{x}{2}$;

(b) $a^2 \sin^2 3x = \sin^2 x$, $a > 0$.

29. $a \cos x + b \sin x = c$, $a^2 + b^2 \neq 0$.

30. At what values of p does the equation $\sqrt{p} \cos x - 2 \sin x = \sqrt{2} + \sqrt{2 - p}$ possess solutions?

31. Solve the equation (a) $2 \cos x + 3 \sin x = 2$;

(b) $\sin x + \cos x = a^2$; (c) $\sin 2x + 3 \cos 2x = a$;

(d) $2 \cos^2 6x - 9 \sin^2 6x + 4 \sin 6x \cos 6x = a + 5$.

32. Find the critical points of the function

$$f(x) = \sin 3x + \frac{4}{3} \cos 3x - ax.$$

Solve the following equations:

33. (a) $\sin x + \sin \left(x + \frac{\pi}{4} \right) = 0$; (b) $\sin 4x - \sin 2x = 0$;

(c) $\sin^2 x - \cos^2 x = \cos \frac{x}{2}$; (d) $\cos 2x - \cos 6x = 0$;

(e) $\cos (3x - 4\pi) = \sin (\pi - x)$,

(f) $\sin \pi x^2 = \sin \pi (x^2 + 2x)$.

34. (a) $\sin \left(x - \frac{\pi}{6} \right) - \sin \left(x + \frac{2\pi}{3} \right) = \cos \left(x + \frac{\pi}{4} \right)$;

(b) $1 + \sin 2x = (\sin 3x - \cos 3x)^2$;

- (c) $\cos 5x + \cos 7x = \cos(\pi + 6x)$;
 (d) $\cos x - \cos 3x = 2\sqrt{3}\sin^2 x$;
 (e) $\sin x + \sin 3x + 4\cos^3 x = 0$;
 (f) $\cos x - \cos 2x = \sin 3x$;
 (g) $\sin x + 2\sin 2x = -\sin 3x$;
 (h) $\frac{\sin x + \sin 2x}{\sin 3x} = -1$.
35. (a) $\sqrt{2}\sin 10x + \sin 2x = \cos 2x$;
 (b) $\cot x \sin 2x - \cos 2x = 1$;
 (c) $\tan 2x \cos 3x + \sin 3x + \sqrt{2}\sin 5x = 0$;
 (d) $2\sin\left(x + \frac{\pi}{3}\right) + 2\cos\left(\frac{x}{2} + \frac{\pi}{4}\right) = 3\sin\left(\frac{x}{4} + \frac{\pi}{8}\right) + \sqrt{3}\cos\left(\frac{x}{4} + \frac{\pi}{8}\right)$.
36. (a) $\sin x + \sin 2x + \sin 3x + \sin 4x = 0$;
 (b) $\cos 9x - \cos 7x + \cos 3x - \cos x = 0$;
 (c) $\cos 5x - \sin 5x = \sin 7x - \cos 7x$;
 (d) $\sin 7x + \cos^2 2x = \sin^2 2x + \sin x$;
 (e) $\cos 2x - \sin 3x - \cos 8x = \sin 10x - \cos 5x$;
 (f) $\sin x + \sin 2x + \sin 3x = 1 + \cos x + \cos 2x$;
 (g) $5\sin x + 6\sin 2x + 5\sin 3x + \sin 4x = 0$;
 (h) $\operatorname{cosec} x - \operatorname{cosec} 2x = \operatorname{cosec} 4x$;
 (i) $\sin a + \sin(x - a) + \sin(2x + a) = \sin(x + a) + \sin(2x - a)$.
37. Find the critical points of the function

$$f(x) = \frac{1}{2}\sin 2x + \frac{1}{4}\sin 4x + \frac{1}{6}\sin 6x + \frac{1}{8}\sin 8x.$$

Solve the following equations:

38. (a) $\tan 3x - \tan x = 0$; (b) $\tan x + \tan 2x - \tan 3x = 0$.
39. (a) $\cos 3x \cos 6x = \cos 4x \cos 7x$;
 (b) $\sin 2x \sin 6x = \cos x \cos 3x$;
 (c) $\cos 3x \sin 7x = \cos 2x \sin 8x$;
 (d) $\sin 5x \cos 3x = \sin 6x \sin 2x$;
 (e) $\sin\left(\pi x + \frac{\pi}{4}\right) \sin\left(\pi x - \frac{\pi}{12}\right) = \frac{1}{2}$.

40. (a) $\sin^2 x + \sin^2 2x = \sin^2 3x$;
 (b) $\cos^2 x + \cos^2 2x + \cos^2 3x + \cos^2 4x = 2$;
 (c) $\sin 7x + \sin 9x = 2 \left[\cos^2 \left(\frac{\pi}{4} - x \right) - \cos^2 \left(\frac{\pi}{4} + 2x \right) \right]$;
 (d) $\sin^2 2x + \sin^2 x = \frac{9}{16}$.
41. (a) $\sin x + \sin 2x + \sin 3x = \frac{1}{2} \cot \frac{x}{2}$;
 (b) $\cos x + \cos 2x + \cos 3x = -0.5$.
42. (a) $\sin^3 x \cos 3x + \cos^3 x \sin 3x + 0.375 = 0$;
 (b) $\cos^3 x \cos 3x + \sin^3 x \sin 3x = \sqrt{2}/4$.
43. (a) $\sin x \sin \left(\frac{\pi}{3} - x \right) \sin \left(\frac{\pi}{3} + x \right) = \frac{1}{8}$;
 (b) $8 \cos x \cos \left(\frac{\pi}{3} - x \right) \cos \left(\frac{\pi}{3} + x \right) + 1 = 0$;
 (c) $\tan x \tan \left(x + \frac{\pi}{3} \right) \tan \left(x + \frac{2\pi}{3} \right) = \sqrt{3}$.
44. (a) $\sin 3x = 4 \sin x \cos 2x$; (b) $\sin 3x \cos x = 1.5 \tan x$;
 (c) $\tan x \cot 3x = 4$; (d) $6 \tan x + \frac{5}{\tan 3x} = \tan 2x$;
 (e) $\sin x \cos x \sin 3x - \cos 3x \sin^2 x = 6 \cot x$.
45. (a) $2 \sin 3x \sin x + (3\sqrt{2} - 1) \cos 2x = 3$;
 (b) $2 \cos 4x + 5 \cos 2x - 1 = 2 \sin^2 x$;
 (c) $2 + \cos 4x = 5 \cos 2x + 8 \sin^6 x$;
 (d) $\tan^2 x + \cos 4x = 0$; (e) $\tan x + \cot x - \cos 4x = 3$
46. (a) $\sin^4 x - 2 \cos^2 x + a^2 = 0$;
 (b) $\cos^4 x - \sin^2 x \cos^2 x - 3 \sin^4 x =$
 $= 2 \cos 2x - 2a \cos 4x$;
 (c) $\cos^6 x - \sin^6 x = \frac{a}{8} \cos 2x$.
47. (a) $\sin 2x - 12 (\sin x - \cos x) + 12 = 0$;
 (b) $\frac{1}{\sin x} + \frac{1}{\sin \left(x - \frac{3\pi}{2} \right)} = 4 \sin \left(x + \frac{5\pi}{4} \right)$;
 (c) $1 + \tan x = 2\sqrt{2} \sin x$;
 (d) $\sin \left(x + \frac{\pi}{4} \right) = \frac{1}{\sqrt{2}} (1 - \sin x \cos x)$;

- (e) $\sin x + \sin^2 x + \cos^3 x = 0$;
- (f) $\sin \frac{\sqrt{x}}{2} + \cos \frac{\sqrt{x}}{2} = \sqrt{2} \sin \sqrt{x}$.
48. (a) $a \sin x + \tan x + 1 = 1/\cos x$;
- (b) $\sin 2x - 2\sqrt{2}b(\sin x - \cos x) + 1 - 4b = 0$;
- (c) $\sin^3 x + \cos^3 x + a \sin \left(x + \frac{\pi}{4}\right) = 0$.
49. Find the critical points of the function
 $f(x) = 8x - 8(\sin x - \cos x) - \cos 2x + 1$.
- Solve the following equations:**
50. (a) $\sin^2 x + 2 \tan^2 x + \frac{4}{\sqrt{3}} \tan x - \sin x + \frac{11}{12} = 0$;
- (b) $8 \cos x + 6 \sin x - \cos 2x - 7 = 0$;
- (c) $\sin^4 x + \sin^4 \left(\frac{x}{2} + \frac{\pi}{8}\right) + \cos^4 x = 0.5 \sin^2 2x$.
51. (a) $\left(\cos \frac{x}{4} - 2 \sin x\right) \sin x + \left(1 + \sin \frac{x}{4} - 2 \cos x\right) \times$
 $\times \cos x = 0$; (b) $3 \sin 3x = \cos 4x - \sin 9x - \cos 10x$.
52. (a) $\tan x + \frac{1}{9} \cot x = \sqrt{\frac{1}{\cos^2 x} - 1} - 1$;
- (b) $\sin x + \sqrt{3} \cos x = \sqrt{2 + \cos 2x + \sqrt{3} \sin 2x}$.
53. (a) $\sqrt{2 \cos 2x + 2} = \frac{3}{\sqrt{1 + 4 \cos 2x}}$;
- (b) $\sqrt{\sin x} = \sqrt{a \cos x}$.
54. (a) $\sqrt{\sin x} + \sqrt[4]{2} \cos x = 0$; (b) $\sin x + \sqrt{\cos x} = 0$;
- (c) $2 \cos x = \sqrt{2 + 2 \sin 2x}$;
- (d) $\sqrt{\cos^2 x - \cos^2 3x} = \sin 2x$;
- (e) $\sin x + \sqrt{3} \cos x = \sqrt{0.5 + \cos \left(\frac{\pi}{6} - x\right)}$;
- (f) $\frac{1 - a \sin x}{1 + a \sin x} \sqrt{\frac{1 + 2a \sin x}{1 - 2a \sin x}} = 1$.
55. (a) $\sqrt{1 + 4 \sin x \cos x} = \cos x - \sin x$;
- (b) $\sqrt{\cos 2x - \sin 4x} = \sin x - \cos x$;

- (c) $\sqrt{\frac{1+\tan x}{1-\tan x}} = \sin x + \cos x;$
 (d) $4 \sin 3x + 3 = \sqrt{2 \sin 3x + 2};$
 (e) $\sqrt{13 - 18 \tan x} = 6 \tan x - 3;$
 (f) $\sqrt{1 + 8 \sin 2x \cos^2 2x} = 2 \sin \left(3x + \frac{\pi}{4} \right).$
56. (a) $2\sqrt{3 \sin x} = \frac{3 \tan x}{2 \sqrt{\sin x - 1}} - \sqrt{3};$
 (b) $\sqrt{\sqrt{3} \cos x + \sin x - 2} + \sqrt{\cot 3x + \sin^2 x - \frac{1}{4}} =$
 $= \sin \frac{3x}{2} + \frac{1}{\sqrt{2}}.$
57. $\sqrt{\cos x - 1/2} + \sqrt{\cos x + 1/3} = a, a \in \mathbb{R}.$
58. (a) $\log_5 \tan x = (\log_5 4) \log_4 (3 \sin x);$
 (b) $\log_9 \sin 2x = \log_3 \sqrt{\frac{\sin x}{5}}.$
59. (a) $2^{\cos 2x} = 3 \cdot 2^{\cos^2 x} - 4;$
 (b) $\cot 2^x = \tan 2^x + 2 \tan 2^{x+1};$
 (c) $x^3 \sin 2x+2 = \sqrt{x}.$

Solve the following systems of equations:

60. (a) $\begin{cases} x - y = 6.5\pi, \\ 3 \cos^2 x - 12 \cos y = -4; \end{cases}$
 (b) $\begin{cases} x + y = \frac{2}{3} \pi, \\ \frac{\sin x}{\sin y} = 2; \end{cases}$
 (c) $\begin{cases} \cos x + \cos y = a, \\ x + y = \pi/4. \end{cases}$
61. (a) $\begin{cases} \sin 3x \cos 2y = 2^a - \cos 3x \sin 2y, \\ \cos(x - y) = 0.5; \end{cases}$
 (b) $\begin{cases} \sin x \sin y = \frac{\sqrt{3}}{4}, \\ \cos x \cos y = \frac{\sqrt{3}}{4}; \end{cases}$

$$\begin{aligned}
& \text{(c) } \begin{cases} \tan x + \tan y = 2, \\ \cos x \cos y = 0.5; \end{cases} \\
& \text{(d) } \begin{cases} \sin x \cos y = 1/4, \\ 3 \tan x = \tan y. \end{cases} \\
62. & \text{(a) } \begin{cases} \tan x - 2 \sin y = -2, \\ 5 \tan x + 2 \sin y = -4; \end{cases} \\
& \text{(b) } \begin{cases} 4 \sin y - 6 \sqrt{2} \cos x = 5 + 4 \cos^2 y, \\ \cos 2x = 0; \end{cases} \\
& \text{(c) } \begin{cases} \frac{1}{\sin x} - \cos y = \frac{a+3}{3}, \\ \sin x \cos y = -\frac{a}{3}; \end{cases} \\
& \text{(d) } \begin{cases} \frac{1}{\cos x} - \tan y = 2a + 2, \\ \tan y + (a^2 + 2a) \cos x = 0. \end{cases} \\
63. & \begin{cases} \sin^2(-2x) - (3 - \sqrt{2}) \tan 5y = (3\sqrt{2} - 1)/2, \\ (3 - \sqrt{2}) \sin(-2x) + \tan^2 5y = (3\sqrt{2} - 1)/2. \end{cases}
\end{aligned}$$

2.8. Trigonometric Inequalities

Solve the following inequalities:

$$\begin{aligned}
1. & \text{(a) } \sin 2x > 0; \text{ (b) } \sin \frac{x}{2} < 0; \\
& \text{(c) } \sin \left(x + \frac{\pi}{4}\right) \leq \frac{1}{2}; \\
& \text{(d) } \sin(2x - 1) > -\frac{1}{\sqrt{2}}; \text{ (e) } \sin x \leq -1. \\
2. & \text{(a) } \cos \frac{x}{3} > 0; \text{ (b) } \cos 4x < 0; \text{ (c) } \cos \left(x - \frac{\pi}{6}\right) \geq \frac{1}{2}; \\
& \text{(d) } \cos \left(\frac{x}{2} + \frac{1}{4}\right) < -\frac{\sqrt{2}}{2}; \text{ (e) } \cos x \geq 1. \\
3. & \text{(a) } \tan 2x > 0; \text{ (b) } \tan \frac{x}{4} < 0; \\
& \text{(c) } \tan \left(x + \frac{\pi}{3}\right) \geq 1; \\
& \text{(d) } \tan(3x - 2) < -\sqrt{3}.
\end{aligned}$$

4. (a) $\cot x < 0$; (b) $\cot\left(x - \frac{\pi}{4}\right) \geq 1$;
 (c) $\cot\left(2x + \frac{\pi}{3}\right) < -2$.
5. (a) $|\sin x| > 1/2$; (b) $|\cos x| < 1/2$; (c) $|\tan x| \leq 1$;
 (d) $|\cot x| < \sqrt{3}$.
6. (a) $\frac{1}{3} \leq \sin x < \frac{1}{2}$; (b) $-\frac{1}{2} < \cos x \leq -\frac{1}{4}$;
 (c) $-2 < \tan x < 3$; (d) $-4 < \cot x \leq 1.5$.
7. $2 \sin^2 x + \sqrt{3} \sin x - 3 > 0$.
8. $\cos 2x + 5 \cos x + 3 \geq 0$.
9. $\tan^2 x + (2 - \sqrt{3}) \tan x - 2\sqrt{3} < 0$.
10. $\cot^2 x + \cot x \geq 0$.
11. $2(\sqrt{2} - 1) \sin x - 2 \cos 2x + 2 - \sqrt{2} < 0$.
12. $\cos \pi x + \sin\left(\pi x - \frac{\pi}{4}\right) > 0$.
13. $\cos^3 x \sin 3x + \cos 3x \sin^3 x < \frac{3}{8}$.
14. $\cos x \cos 2x \cos 3x \leq 0$.
15. $\sin^4 \frac{x}{3} + \cos^4 \frac{x}{3} > \frac{1}{2}$.
16. $\sin^6 x + \cos^6 x > \frac{5}{8}$. 17. $8 \sin^6 x - \cos^6 x > 0$.
18. $\tan x \tan 3x < -1$. 19. $3 \sin 2x - 1 > \sin x + \cos x$.
20. $\sin 2x > \sqrt{2} \sin^2 x + (2 - \sqrt{2}) \cos^2 x$, $0 < x < 2\pi$.
21. $|\sin x| > \cos^2 x$. 22. $\sqrt{5 - 2 \sin x} \geq 6 \sin x - 1$.
23. $1 - \cos x < \tan x - \sin x$.
24. $9^{1 + \sin^2 \pi x} + 30 \cdot 9^{\cos^2 \pi x} \leq 117$.

Find the domain of definition of the following functions:

25. $y = \sqrt{\sin \sqrt{x}}$. 26. $y = \sqrt{\cos x^2}$.
27. $y = \arcsin \frac{2x}{1+x}$. 28. $y = \arccos(2 \sin x)$.
29. $y = \cot \pi x + \arccos 2^x$.

30. Prove that the function $y = \sin^2 x$ increases monotonically on the interval $x \in \left(-\pi; -\frac{\pi}{2}\right)$.
31. Prove that the function $y = \cos^3 x$ decreases monotonically on the interval $x \in \left(\frac{\pi}{2}; \frac{3}{4}\pi\right)$.
32. Prove that if $0 < x_1 < x_2 < \frac{\pi}{2}$, then $\frac{\tan x_2}{\tan x_1} > \frac{x_2}{x_1}$.

Find the critical points of the following functions:

33. $f(x) = 2 \sin a \cos x + \frac{1}{3} \cos 3x + \frac{1}{\sqrt{4a - a^2}}$.
34. $f(x) = \left(1 - \frac{\cos a}{4}\right) \sin 2x + \frac{1}{8} \sin(\pi + 4x) + x \left(\frac{\cos a - 3}{2}\right) + \sqrt{2a - a^2 + 3}$.
35. $f(x) = \frac{1}{3} \sin a \tan^3 y + (\sin a - 1) \tan x + \frac{\sqrt{a-2}}{\sqrt{8-a}}$.

Chapter 3

PROBLEMS ON DERIVING EQUATIONS AND INEQUALITIES

3.1. Problems on Motion

1. The train left station A for station B . Having travelled 450 km, which constitutes 75 per cent of the distance between A and B , the train was stopped by a snow-drift. Half an hour later the track was cleared and the engine-driver, having increased the speed by 15 km per hour, arrived at station B on time. Find the initial speed of the train.
2. A motor-boat went down the river for 14 km and then up stream for 9 km, having covered the whole way in five hours. Find the speed of the river flow if the speed of the boat in still water is 5 km/h.
3. In accordance with the schedule, the train is to travel the distance between A and B , equal to 20 km, at a constant speed. It travelled half a way with the specified speed and stopped for three minutes; to arrive at point B

- on time, it had to increase its speed by 10 km/h for the rest of the way. Next time the train stopped half-way for five minutes. At what speed must it travel the remaining half of the distance to arrive at point B in accordance with the schedule?
4. A cyclist left point A for point B and travelled at the constant speed of 20 km/h. When he covered the distance of $8\frac{1}{3}$ km, he was overtaken by a car, which left point A fifteen minutes later and travelled at a constant speed too. When the cyclist travelled another 25 km, he encountered the car returning from B , where it stopped for half an hour. Find the distance between A and B .
 5. A boat goes down the river from point A to point B , which is at the distance of 10 km from A , and then returns to A . If the actual speed of the boat is 3 km/h, then it takes 2 h 30 min less for the boat to go from A to B than from B to A . What should the actual speed of the boat be for the distance from A to B to be covered in two hours?
 6. The distance between A and B is 30 km. A bus left A and first travelled at a constant speed. Ten minutes later a helicopter left A and flew along the highroad to B . It overtook the bus in five minutes and continued on its way to B . Without landing at B , the helicopter turned back and again encountered the bus 20 minutes after it left point A . Determine the speeds of the bus and the helicopter.
 7. A goods train left the town M for the town N at 5 a.m. An hour and a half later a passenger train left M , whose speed was 5 km/h higher than that of the goods train. At 9 : 30 p.m. of the same day the distance between the trains was 21 km. Find the speed of the goods train.
 8. If a steamer and a motor-launch go down stream, then the steamer covers the distance from A to B 1.5 times as fast as the motor-launch, the latter lagging behind the steamer 8 km more each hour. Now if they go up stream, then the steamer covers the distance from B to A twice as fast as the motor-launch. Find the speeds of the steamer and the motor-launch in still water.
 9. Point C is at a distance of 12 km from point B down the river. A fisher left point A , which is somewhat farther

- up the river than point B , for point C in a boat. He arrived at C four hours later and covered the return trip in six hours. Fixing a motor to the boat and thus trebling its speed relative to the water, the fisher covered the distance from A to B in 45 minutes. Determine the speed of the river flow, considering it to be constant.
10. Two people left simultaneously two points: one left point A for point B and the other left B for A . Each of them walked at a constant speed and, having arrived at the point of destination, went back at once. First time they met 12 km from B , and the second time, six hours after the first meeting, 6 km from A . Find the distance between A and B and the speeds of the two people.
 11. Two aeroplanes, leaving simultaneously points A and B and flying towards each other, meet at the distance of a km from the midpoint of the distance AB . If the first aeroplane left b hours later than the second, they would meet at the midpoint of AB . Now if the second aeroplane left b hours later than the first, then they would meet at a quarter of the way from B . Find the distance AB and the speeds of the aeroplanes.
 12. Two tourists left simultaneously point A for point B , the first tourist covering each kilometre 5 minutes faster than the second. After travelling a fifth of the way, the first tourist returned to A , stopped there for ten minutes and again started for B . The two tourists arrived at B simultaneously. What is the distance between A and B if the second tourist covered it in 2.5 hours?
 13. Two cyclists left the same point simultaneously and travelled in the same direction. The speed of the first was 15 km/h and that of the second was 12 km/h. Half an hour later, another cyclist left the same point and travelled in the same direction. Some time later, he overtook the second cyclist and another hour and a half later he overtook the first cyclist. Find the speed of the third cyclist.
 14. The smaller arc AB of the circle is l cm in length. At the time moment $t = 0$, the points P_1 and P_2 moving along the circle are at the points A and B respectively. If points P_1 and P_2 move towards each other along the smaller arc, they will meet in t_1 seconds, and if they move along the larger arc, then they will meet in t_2

seconds. Point P_1 completes the circle in a time needed for P_2 to cover S cm. Find the length of the circle and the speeds of the points P_1 and P_2 , considering the motion of the points along the circle to be uniform.

15. Two bodies, moving along a circle in the same direction, meet every 56 minutes. Had they moved at the same speeds in the opposite directions, they would meet every eight minutes. If, moving in the opposite directions, the bodies are at the distance of 40 m from each other along the arc at some moment of time, then in 24 seconds, that distance will be 26 metres (the bodies never meet during those 24 seconds). Find the speeds of the bodies and the length of the circle.
16. The distance between points A and B located on a straight highway is 15 km. A cyclist leaves A at a constant speed of 8 km/h and a motor-cyclist leaves B and travels in the same direction with a constant acceleration of 2 km/h². In what time interval after their start will the distance between the cyclist and the motor-cyclist be 750 m if they start simultaneously? The initial speed of the motor-cyclist is zero.
17. The students went boating down the river at the distance of 20 km. Then they turned back and returned to the moorings, having travelled for seven hours. On their return trip, at the distance of 12 km from the moorings, they encountered a raft, which passed the moorings at the moment at which the students started boating. Determine the speed of the boat down stream and the speed of the river flow.
18. Two ships started simultaneously from the port, one to the north and the other to the east. Two hours later, the distance between them turned out to be 60 km. Find the speed of each ship, knowing that the speed of one of them was 6 km/h higher than the speed of the other.
19. Points A , B and C are at the distances of 60, 55 and 56 km from point M respectively. Three people left those points for point M simultaneously: the first person started from point A , the second from B and the third from C . The first person covered the whole way at a constant speed and arrived at M two hours before the second and the third persons who arrived simultaneously. The second person, having travelled 40 km at the same speed as the first, stopped for an hour. The

- rest of the way he travelled at a speed which is less than the speed of the third person by the same amount as the speed of the third is less than that of the first. The third person covered the whole way at a constant speed. Determine the speeds of the first and the third person.
20. The road passes through points A and B . Simultaneously and in the same direction a motor-cyclist started from A (in the direction of B) and a cyclist started from B . The motor-cyclist overtook the cyclist at the distance of a km from B . Had they both left simultaneously A for B , then, at the moment the motor-cyclist arrived at B , the cyclist would be b km behind. Determine the distance between A and B , the speeds of the motor-cyclist and the cyclist being constant.
 21. Two people started simultaneously from points A and B towards each other. At the moment the person who started from A covered two-thirds of the way, the other person was two km from the middle of the way. Find the distance between A and B , if it is known that when the person who started from B covered $3/16$ of the way, the first person was three km from the middle of the way. The speeds of the two people were constant.
 22. Two people left point A simultaneously. Twenty minutes later, the first person met a tourist travelling to A , while the second person met the tourist five minutes later than the first. Ten minutes after the tourist met the second person, he arrived at A . The speeds of the two people and the tourist were constant. Find the ratio of the speeds of the two people.
 23. A motor-cyclist left point A for point B . Two hours later, a car left A for B and arrived at B at the same time as the motor-cyclist. Had the car and the motor-cycle started simultaneously from A and B travelling towards each other, they would meet an hour and twenty minutes after the start. How much time did it take the motor-cyclist to travel from A to B ?
 24. The road passes through points A and B . A cyclist started from A in the direction of B . At the same time, two pedestrians started from B , travelling at the same speed, the first of them in the direction of point A and the other in the opposite direction. The cyclist covered the distance AB in half an hour and, keeping ahead, overtook the second pedestrian, 1.2 hours after he met

- the first pedestrian. Determine the time the cyclist spent travelling from the point of departure to the point of the meeting with the first pedestrian, the speeds of the cyclist and the pedestrians being constant.
25. The towns A and B are on the river bank. It takes a tugboat 13 hours to travel from A to B and back again, and a motor-launch, whose actual speed is twice that of the tugboat, covers the same distance in six hours. How many times is the actual speed of the tugboat higher than the speed of the river flow?
 26. A motor-boat left point A travelling up stream, and at the same time a raft left point B travelling down stream. They met a hours later and then travelled on without stops. Having reached B , the boat turned at once and, on her way back, overtook the raft at point A . The actual speed of the boat is assumed to be constant. How long did it take the raft and the boat to make their trips?
 27. Two pedestrians started simultaneously towards each other and met each other 3 h 20 min later. How much time will it take each of them to cover the whole distance if the first arrived at the place of departure of the second five hours later than the second arrived at the point of departure of the first?
 28. Two cyclists started simultaneously from points A and B travelling towards each other; 1.6 hours later the distance between them was 0.2 of the original distance. How many hours does it take each of them to cover the distance AB if the first needs three hours less to travel that distance than the second?
 29. Three skiers cover the distance running at uniform speeds; m minutes after the start, it remains for the third skier to run the part of the distance, which the first skier can run in n min and the second skier, in p min. How many minutes does it take each skier to run the whole distance if the speed of the third skier is equal to half the sum of the speeds of the first two?
 30. Two cars left points A and B simultaneously, travelling towards each other; 16 hours after their meeting, the car travelling from A arrived at B , and 25 hours after their meeting, the car travelling from B arrived at A . How many hours did it take each car to cover the whole trip?

31. A pedestrian and a cyclist left point A for point B at the same time. Having reached point B , the cyclist turned back and met the pedestrian an hour after the start. After their meeting, the pedestrian continued his trip to B and the cyclist turned back and also headed for B . Having reached B , the cyclist turned back again and met the pedestrian 40 minutes after their first meeting. Determine what time it takes the pedestrian to cover the distance between A and B .
32. Two cars left simultaneously points A and B and met each other at noon sharp. If the first of them doubles its speed and the second continues at the same speed, then their meeting will occur 56 minutes earlier. Now if the second car doubles its speed and the first continues at the original speed, their meeting will occur 65 minutes earlier. Determine the time of the meeting in the case when both cars double their speed.

3.2. Problems on Percentage, Mixtures, Numbers and Work

1. Three navvies dug a ditch of 216 m in four days working simultaneously. During one shift, the third navvy digs as many metres more than the second as the second digs more than the first. During five days, the third navvy digs as many metres as the first digs during seven days. How many metres does the first navvy dig per shift?
2. At first only two galleries of the coal mine were operative, and some time later, the third gallery joined in. As a result, the output of the mine became half as large again. What, in per cent, is the capacity of the second gallery as compared to that of the first, if it is known that a four-months output of the first and the third galleries was the same as the annual output of the second gallery?
3. Three workers completed the job in 10 days, the third worker having worked only the first three days. How many days would it take every worker to do the job if it is known that, working together, they did 37% of the job for the first three days, and during five days the first worker did the same amount that the second worker did during four days?

4. Working together, two workers did the whole job in five days. Had the first worker worked twice as fast and the second worker half as fast, it would take them four days to complete the job. How much time would it take the first worker alone to do the job?
5. Two scrapers of different capacity can do the job in six hours if they work together. If the first scraper alone worked for four hours and then the second scraper alone worked for six hours, they would do 80% of the whole job. How many hours would it take each scraper to complete the job if they worked separately?
6. Three workers have to make 80 identical workpieces. They are known to make 20 pieces an hour if they work together. First, one worker began working alone and made 20 pieces having worked more than three hours. The remaining part of the job was done by the second and the third worker who worked together. It took eight hours to complete the job. How many hours would it take the first worker to do the job if he worked alone from the very beginning and to the end?
7. It takes six days for three ordinary ploughs and two tractor ploughs working together to plough the field. Three tractor ploughs would do the same job five days sooner than nine ordinary ploughs. How many times does the output of a tractor plough exceed that of an ordinary plough?
8. Each of the three workers needs some time to do a certain job, and the third worker needing an hour less to complete the job than the first worker. When they all work together, they do the job in an hour. Now if the first worker works for an hour alone, then it would take the second worker four hours to complete the job. How soon can each worker do the job?
9. Two excavators are operating. If the first excavator worked alone, it would need eight hours more to complete the job than if they both worked together. Now if the second excavator worked alone, it would need 4.5 hours more to complete the job than they both working together. What time would it take each excavator to do the job if they worked separately?
10. For t minutes one machine-tool produces d workpieces more than the other. If it were possible to reduce the time needed by each machine-tool to manufacture a

workpiece by two minutes, then in t minutes the first machine-tool would produce $2d$ workpieces more than the second. How many pieces does each machine-tool produce in t minutes?

11. Two pieces of the same fabric cost 91 roubles. When as many metres from the first piece were sold as the second piece contained originally and half as many metres were sold from the second piece as the first piece contained originally, the remainder of the first piece turned out to contain 10 metres more than the remainder of the second piece. How many metres did each piece contain if a metre of the fabric costs 1 rouble and 40 kopecks?
12. A fashion house got black, green and blue fabric, one piece each colour. The cost of the pieces was the same although the piece of the green fabric contained nine metres less than the piece of the black fabric and six metres more than the piece of the blue fabric. It is also known that the cost of 4.5 metres of the black fabric is equal to the cost of 3 metres of the green fabric and 0.5 metre of the blue fabric taken together. How many metres did each piece contain?
13. A tank of 2400 cu m capacity is being filled with fuel. The delivery of the pump discharging the tank is 10 cu m/min higher than the delivery of the pump filling the same tank. As a result, eight minutes less time is needed to discharge the tank to fill it up. Determine the delivery of the pump filling the tank.
14. A reservoir is filled with water through two valves. The first valve was open for a third of the time needed for the second valve to fill the reservoir. Then the second valve alone was open for half the time needed for the first valve to fill the reservoir. As a result, the reservoir was filled to $\frac{5}{6}$ of its capacity. Both valves together can fill up the reservoir in 2.4 hours. What time will it take each valve separately to fill up the reservoir?
15. A tank of 425 cu m capacity has been filled with water through two valves, the first valve having been opened five hours longer than the second. Were the first valve open as long as the second valve was actually open, and were the second valve open as long as the first valve was open, then the first valve would deliver half the

amount of water delivered by the second valve; if the two valves were open simultaneously, the tank would be filled up in 17 hours. How long was the second valve open?

16. Two turners and an apprentice are entrusted with a rush order. The first turner needs three hours more to cope with the job than the second turner and the apprentice would need working together. The second turner, working alone, would need as much time as the first turner and the apprentice working together. The second turner, working alone, would spend eight hours less than the double period of time the first turner would spend working alone. How much time would the two turners and the apprentice need to complete the task if they worked all together?
17. Three workers of different skills did a certain job, the first worker having worked six hours, the second four hours and the third seven hours. Had the first worker worked four hours, the second two hours and the third five hours, they would do only two-thirds of the whole job. How many hours would the workers need to complete the job had they worked all together for the same time period?
18. Four pipes are fixed to the reservoir. Through the first three pipes the reservoir can be filled in 12 minutes; through the second, the third and the fourth pipe it can be filled in 15 minutes; and through the first and the fourth pipe, in 20 minutes. How much time will it take all the four pipes to fill up the reservoir?
19. One kind of iron ore contains 72% of iron and the other contains 58%. A certain amount of the first kind of ore is mixed with a certain amount of the second and the resulting ore contains 62% of iron. If we take 15 kg more ore of each kind than it was actually taken, we shall obtain a kind containing $p\%$ of iron. How many kilograms of the first and the second kind were taken to form the first mixture?
20. A first vessel of six litres capacity was filled with four litres of 70-per cent solution of sulphuric acid; a second vessel of the same capacity was filled with three litres of 90-per cent solution of sulphuric acid (per cent by volume being meant). How many litres of solution should be transferred from the second vessel to the first

for a q -per cent solution of sulphuric acid to result in the first vessel?

21. After two consecutive rises, the salary constituted $\frac{15}{8}$ of the original value. What was the first rise, in per cent, if the second rise was double the first (in per cent)?
22. The deposit being at the bank from the beginning of a year is known to increase by some per cent to the end of the year (the percentage being different for various banks). Some money, constituting three fifths of a certain amount was deposited at the beginning of the year at the first bank, and the rest of the money was deposited at the second bank. Towards the end of the year the sum of the deposits equalled 590 monetary units, towards the end of the second year it equalled 701 monetary units. When calculations were performed, it turned out that if, originally, three-fifths of the initial amount of money had been deposited at the second bank and the remaining part had been deposited at the first bank, then towards the end of the year the sum of the deposits at those banks would have been equal to 610 monetary units. What would the sum of the deposits have been towards the end of the second year in that case?
23. A litre of glycerin was poured out of a vessel filled up with pure glycerin to the brim and a litre of water was poured in. After the solution was mixed up, a litre of the mixture was poured out again and a litre of water was added. The resulting solution was mixed up again and again a litre of the mixture was poured out and a litre of water was added. As a result of these operations, there was seven times as much water in the vessel (by volume) as the remaining glycerin. How many litres of glycerin and water turned out to be in the vessel as a result of the operations performed?
24. One-tenth of the salt solution contained in a retort was poured out into a test-tube. Then a part of the water contained in the test-tube was vapourized by heating and, as a result, the percentage of the salt in the test-tube increased k times. What was the original percentage of the salt in the retort, if it is known that after the content of the test-tube was poured into the retort, the percentage of the salt in the retort increased by a per cent?

25. There are three pieces of a copper-tin alloy. The masses of the pieces are in the ratio of 3 : 4 : 5. The percentage of copper in the second piece is a times as large, and in the first piece a times as small, as in the third piece. After the three alloys were smelted together, a new alloy of copper and tin was obtained, in which the percentage of copper changed by p per cent as compared to the percentage of copper in the third piece. What was the original percentage of copper in the alloys?
26. The difference between the digits in a two-digit number is equal to 2, and the sum of the squares of the same digits is 52. Find the number.
27. If we divide a given two-digit number by the product of its digits, we obtain 3 as a quotient and 9 as a remainder. Now if we subtract the product of the digits constituting the number from the square of the sum of its digits, we obtain the given number. Find it.
28. Find the three-digit number if it is known that the sum of its digits is 17 and the sum of the squares of its digits is 109. If we subtract 495 from this number, we obtain a number consisting of the same digits written in reverse order.
29. The sum of the cubes of the digits constituting a two-digit number is 243 and the product of the sum of its digits by the product of its digits is 162. Find the two-digit number.

3.3. Problems on Deriving Inequalities and Systems of Inequalities. Problems on the Extremum

1. In a four-digit number, the sum of the digits in the hundred's place, ten's place and unit's place is 14, the sum of the digits in the thousand's place and the unit's place is 9, the digit in the hundred's place exceeds the digit in the ten's place by 4. Among all numbers satisfying the indicated conditions, find that for which the sum of the product of the digit in the thousand's place by the digit in the unit's place and the product of the digit in the ten's place by the digit in the hundred's place assumes the greatest value.
2. A boat sails down the river to the distance of 10 km and then sails 6 km up the river. The velocity of the river flow is 1 km/h. In what limits should the actual

- speed of the boat be for the whole trip to take from 3 to 4 hours?
3. We have bought several identical books and albums and payed 10 roubles 56 kopecks for the books and 56 kopecks for the albums. There were six more books than the albums. How many books have we bought if the cost of a book exceeds by more than a rouble that of an album?
 4. Two points began moving simultaneously from point A along a straight line in the same direction: the first point moved with a uniform acceleration, at the initial velocity of 3 m/s and the acceleration 2 m/s^2 , the second point moved uniformly. In what limits can the velocity of the second point change so that the second point should first leave behind the first point and then the first point should overtake the second point at the distance not greater than 10 m from A ?
 5. A student puts all his stamps into a new album. If he puts 20 stamps on one page, the album will not be enough, and if he puts 23 stamps on one page, then at least one page remains empty. If we present the student with one more album of the same kind whose every page contains 21 stamps, he will have 500 stamps. How many pages are there in the album?
 6. A group of students decided to buy a tape-recorder at the price of 170-195 roubles. At the last moment, however, two of them refused to participate and, therefore, the remaining students had to add one rouble each. What was the price of the recorder?
 7. Several people were to take part in an excursion. At the last moment, however, two of them refused to go and, therefore, each of the remaining tourists had to pay 3 roubles more for the excursion than it was planned before (all the participants had to pay the same sum of money). How much had each tourist to pay originally if the excursion costs more than 70 roubles, but not more than 75 roubles?
 8. A number of identical lorries were hired to transfer goods from one place to another. Since the road was bad because of some repairs, each lorry could take 0.5 ton less than was planned and, therefore, four additional lorries of the same kind were hired. The weight of the goods transferred was larger than 55 tons but did not

- exceed 64 tons. How many tons of goods did each lorry transfer?
9. Points A and B are located on the same river so that a raft sailing from A to B with the velocity of the river flow covers the way from A to B in 24 hours. A motor-launch covers the whole way from A to B and back again in not less than 10 hours. If the speed of the motor-launch in still water increased by 40%, then it would take the motor-launch not more than seven hours to cover the same way (from A to B and back again). Find the time necessary for the motor-launch to sail from B to A when its speed in still water is not increased.
 10. Thirty students took an examination and got the marks 2, 3, 4 and 5. The sum of the marks is equal to 93, the threes being more than the fives and less than the fours. Besides, the number of the fours was divisible by 10 and the number of the fives was even. How many marks of every kind the 30 students got?
 11. Limes and birches have been planted about the house, their total number being 14. If we double the number of the limes and increase by 18 the number of the birches, then the birches will be greater in number. If we double the number of the birches, without changing the number of the limes, there will be more limes all the same. How many limes and how many birches were planted?
 12. Two cars go at constant speeds of 40 and 50 km/h along two streets towards the crossing. The streets make the angle of 60° . At the initial moment of time the cars were at the distances of 5 and 4 km from the crossing respectively. In what time will the distance between them become the least?
 13. Three pipes are attached to the reservoir. The first pipe pours in 30 cu m of water per hour. The second pipe pours in $3V$ cu m of water less than the first pipe ($0 < V < 10$), and the third pipe pours in $10V$ cu m an hour more than the first pipe. First, the first and the second pipes operated together and filled 0.3 of the reservoir, and then all the three pipes operated together and filled the rest 0.7 of the reservoir. At what value of V will the filling of the reservoir be the quickest?
 14. A pedestrian left point A for a walk, going with the speed of v km/h. When the pedestrian was at the distance

- of 6 km from A a cyclist followed him, starting from A and cycling at a speed 9 km/h higher than that of the pedestrian. When the cyclist overtook the pedestrian, they turned back and returned to A together, at the speed of 4 km/h. At what v will the time spent by the pedestrian on his stroll be the least?
15. A vessel of 5 litres capacity contains 2 litres of p -per cent (by volume) salt solution. How many litres of a 20-per cent solution of the same salt must be poured into the vessel for the percentage of the salt in the vessel to become the greatest?
 16. There are three alloys. The first contains 45% of tin and 55% of lead, the second contains 10% of bismuth, 40% of tin and 50% of lead, and the third contains 30% of bismuth and 70% of lead. They must be used to produce a new alloy containing 15% of bismuth. What is the greatest and the least percentage of lead that can be contained in this new alloy?
 17. A body began moving rectilinearly at the time moment $t = 0$ at the initial velocity of 3 m/s. One second later, the velocity of the body became equal to 4 m/s. Find the acceleration of the body at the end of the first second and the length of the path traversed by the body for the first four seconds, if the velocity of the body changes by the law $v(t) = (at^2 + 2t + b)$.

Chapter 4

THE ANTIDERIVATIVE AND THE INTEGRAL

4.1. The Antiderivative. The Newton-Leibniz Formula

Find the antiderivatives of the following functions:

1. (a) $y = 2$; (b) $y = -3x + 1$; (c) $y = 4(2x - 1)$.
2. (a) $y = -x^2$; (b) $y = x^2 - 4x - \sqrt{3}$;
(c) $y = 18(3x + 2)^2$.
3. (a) $y = x - 3x^3$; (b) $y = \frac{1}{2}x + x^5$; (c) $y = x^2 - x^4$;
(d) $y = (3x - 4)^{100}$; (e) $y = (1 - 5x)^7$.

4. (a) $y = \frac{1}{x^2}$; (b) $y = \frac{1}{x^2} - x$; (c) $y = 4x + \frac{1}{(2x-1)^2}$;
 (d) $y = \frac{1}{(1-x)^3} - \frac{1}{(1+x)^3}$.
5. (a) $y = \frac{1}{4\sqrt{x}}$; (b) $y = \sqrt[3]{x} - 1$; (c) $y = \sqrt[4]{x^3 + x}$;
 (d) $y = \sqrt[7]{x} - \sqrt[3]{x} + \sqrt[6]{x}$; (e) $y = \sqrt{x+2}$;
 (f) $y = \sqrt{5-4x}$.
6. (a) $y = \frac{2}{x}$; (b) $y = -\frac{1}{2x}$; (c) $y = \frac{1}{1-x}$;
 (d) $y = \frac{3}{4x-1}$.
7. (a) $y = \frac{1}{x+1} - \frac{1}{x-1}$; (b) $y = \frac{1}{x(x+1)}$;
 (c) $y = \frac{1}{x^2+5x+4}$; (d) $y = \frac{2x+3}{x^2+3x}$.
8. (a) $y = \frac{1}{1+x^2}$; (b) $y = \frac{2}{x^2+4}$;
 (c) $y = \frac{4x^2+1}{x^2(1+x^2)}$; (d) $y = \frac{(x+1)^2}{x(1+x^2)}$.
9. (a) $y = \frac{4}{\sqrt{1-x^2}}$; (b) $y = -\frac{1}{\sqrt{1-4x^2}}$;
 (c) $y = \frac{\sqrt{1-x^2}+1}{1-x^2}$.
10. (a) $y = 2^x$; (b) $y = 3^{-x}$; (c) $y = 2e^{4x} + x$;
 (d) $y = e^{-x}$; (e) $y = \frac{e^x + e^{-x}}{2}$;
 (f) $y = \frac{e^x - e^{-x}}{2}$.
11. (a) $y = 2 \sin x$; (b) $y = 3 \sin \frac{x}{2}$;
 (c) $y = \sin(x - \pi/3)$;
 (d) $y = -5 \sin(10x + \pi/8)$.
12. (a) $y = 4 \cos(-x)$; (b) $y = -2 \cos \frac{x}{5}$;
 (c) $y = \cos\left(\frac{x}{2} + \frac{\pi}{6}\right)$; (d) $y = 2 \cos(7x - 1)$.

13. (a) $y = \sin^2 x$; (b) $y = -2 \cos^2 2x$;
 (c) $y = 2 \cos x \cos 5x$; (d) $y = 2 \sin 4x \sin 7x$;
 (e) $y = 2 \sin 8x \cos 3x$; (f) $y = 2 \sin x \cos 11x$.
14. (a) $y = \frac{3}{\cos^2 4x}$; (b) $y = \frac{2}{\sin^2 \frac{x}{2}}$;
 (c) $y = \tan^2 x$; (d) $y = \cot^2 x$.
15. Find the antiderivative of the function $f(x)$ whose graph passes through the point $M_0(x_0, y_0)$, if
 (a) $f(x) = 3x^2 - 2$, $M(2; 4)$; (b) $f(x) = 1 + \cos x + \cos 2x$; $M(0; 1)$; (c) $f(x) = 3 \cos x - 2 \sin x$, $M(\pi/2; 1)$; (d) $f(x) = e^{x/2}$, $M(0; 3)$.
16. Find the derivative of the function (a) $F(x) = \int \arcsin^2 x dx$; (b) $F(x) = \int_1^x (\sin^8 t + \sqrt{t^4 + 1}) dt$.
17. Find the critical points of the function
 (a) $f(x) = \int_1^x [t(t+1)(t+2)(t+3) - 24] dt$;
 (b) $f(x) = \frac{2}{3} \sqrt{x^3} - \frac{x}{2} + \int_1^x \left(\frac{1}{2} + \frac{1}{2} \cos 2t - t^{\frac{1}{2}} \right) dt$;
 (c) $f(x) = \int_2^x (\sin^2 t + \sin^2 2t + \sin^2 3t - 1.5) dt$;
 (d) $f(x) = \int_0^x (\sin^2 2t - 2 \cos^2 2t + a) dt$;
 (e) $f(x) = \int_0^x (\sin 3t - 3 \sin t + 0.5) dt$.
18. Calculate the integral
 (a) $\int_3^{-18^3} \sqrt{2 - \frac{x}{3}} dx$; (b) $\int_{-1}^1 x(x^2 - 1)^5 dx$;
 (c) $\int_{\sqrt{2}}^{\sqrt{e+1}} \frac{2x dx}{x^2 - 1}$;

$$(d) \int_{-2}^0 (\arcsin(x+1) + \arccos(x+1)) dx;$$

$$(e) \int_{-1}^3 \left(\arctan \frac{x}{x^2+1} + \operatorname{arccot} \frac{x}{x^2+1} \right) dx.$$

19. Find the set of positive values of a satisfying the

$$\text{equation } \int_0^a (3x^2 + 4x - 5) dx = a^3 - 2.$$

20. Find all the values of a for which the inequality

$$\frac{1}{\sqrt{a}} \int_1^a \left(\frac{3}{2} \sqrt{x+1} - \frac{1}{\sqrt{x}} \right) dx < 4 \text{ is satisfied.}$$

21. Find all the values of α belonging to the interval

$$[0, 2\pi] \text{ and satisfying the equation } \int_{\frac{\pi}{2}}^{\alpha} \sin x dx = \sin 2\alpha.$$

22. Solve the equation

$$\int_{-1}^x \left(8t^2 + \frac{28}{3}t + 4 \right) dt = \frac{1.5x+1}{\log_{x+1} \sqrt{x+1}}.$$

4.2. Calculating the Areas of Plane Figures

Find the areas of the figures bounded by the following curves:

1. (a) $y = x$, $x = 1$, $y = 0$; (b) $y = 2x$, $y = 4x$, $x = 2$;
 (c) $y = 2x$, $y = 4x$, $y = 3$;
 (d) $3x - 4y + 11 = 0$, $4x + 3y - 27 = 0$,
 $x + 7y - 13 = 0$.
2. (a) $y = x^2$, $x = -4$, $y = 0$; (b) $y = x^2$, $y = 9$, $x = 0$;
 (c) $y = x^2 + 1$, $x = -3$, $x = 6$, $y = 0$;
 (d) $y = -3x^2 - 2$, $x = 1$, $x = 2$, $y = -1$;
 (e) $y = 4x - x^2$, $y = 0$; (f) $y = x^2 - 5x + 4$, $y = 0$.
3. (a) $y = x^2 - 2x + 3$, $x + y = 5$;
 (b) $y = x - 5 - 3x^2$, $y = 7x - 5$;
 (c) $y = x^2 - 6x + 5$, $x = 11 - y$;
 (d) $y = x^2$, $|y| = x$;
 (e) $y^2 = 1 - x$, $y = 2x - 1$, $x = 0$.

4. Find the area of the figure bounded by the parabola $y = -x^2 + 7x - 12$, a tangent to that parabola, passing through its vertex, and the coordinate axes.
5. Find the area of the figure bounded by the parabola $y = 0.5x^2 - 2x + 2$ and a tangent to that parabola drawn at the points $A(1; 1/2)$ and $B(4; 2)$.
6. Find the area of the figure bounded by the straight line $y = -9x - 59$ and the parabola $y = 3x^2 + ax + 1$, if the tangent to the parabola at the point $x = -2$ is known to make the angle $\arctan 6$ with the x -axis.
7. Find the area of the figure bounded by the parabola $y = ax^2 + 12x - 14$ and the straight line $y = 9x - 32$, if the tangent drawn to the parabola at the point $x = 3$ is known to make the angle $\pi - \arctan 6$ with the x -axis.
8. The area of a curvilinear trapezoid bounded by the curve $y = 3x^3 + 2x$ and the straight lines $x = a$ and $y = 0$ is equal to unity. Find a .
9. Find the values of c for which the area of the figure bounded by the curve $y = 8x^2 - x^5$, the straight lines $x = 1$ and $x = c$ and the abscissa axis is equal to $16/3$.

Find the areas of the figures bounded by the following curves:

10. (a) $y = 5/x$, $y = 4$, $x = 7$;
 (b) $y = 1/(x - 1)$, $y = 5 - 2x$, (c) $xy = 5$,
 $x + y = 6$; (d) $x = |y - 2|$, $y = 1/(1 - x)$.
11. (a) $y = 8/x^2$, $y = x$, $x = 4$;
 (b) $y = 4/x^2$, $y = -4x$, $x = -2y$;
 (c) $y = -1/x^3$, $y = 27$, $16y = -x$.
12. Find the area of the figure bounded by the hyperbola $y = -4/x$, a tangent to that curve drawn at the point $x = 2$ and the straight line $x = 3$.
13. Find the values of c for which the area of the figure bounded by the curves $y = 4/x^2$, $x = 1$ and $y = c$ is equal to $2\frac{1}{4}$.

Find the areas of the figures bounded by the following curves:

14. (a) $y = \sqrt{x-1}$, $y = 3 - x$, $y = 0$; (b) $y = x^2$, $x = y^2$;
 (c) $y = \sqrt{x}$, $y = \sqrt{4-3x}$, $y = 0$;
 (d) $y = -x^3$, $y = \sqrt{x}$, $y = 8$.

15. (a) $y = 4 - x^2$, $y = x^2 - 2x$;
 (b) $y = -x^2 + 6x - 2$, $y = x^2 - 2x + 4$;
 (c) $y = 2x^2 - x + 1$, $y = (x - 7)^2$, $x = 1.5$, $y = 0$.
16. (a) $y = x^2$, $y = 1/x$, $y = 0$, $x = 2$;
 (b) $3 - y = 4/(x + 2)$, $y = x^2 - 1.5x + 1$;
 (c) $y = -2x^2 + 5x + 3$, $y + 1 = 4/(x + 1)$;
 (d) $y = -16x$, $y = -x^3$, $y = 1$;
 (e) $y = 8/x^2$, $2y = x^2$, $y = -8x$ ($x \geq -2$);
 (f) $y = -1/x$, $y = x^2$, $8y = x^2$.
17. (a) $y = 3(x - 1)/(x - 2)$,
 $x = 2(y + 1)/(y - 1)$, $x = 3$, $x = 5$;
 (b) $y = 1 + \frac{1}{3(x-4)}$, $y = 1/(6x)$.
18. At what values of a is the area of the figure bounded by the curves $y = 1/x$, $y = 1/(2x - 1)$, $x = 2$ and $x = a$ equal to $\ln \frac{4}{\sqrt{5}}$?

Find the areas of the figures bounded by the following lines:

19. (a) $y = 3^x$, $x = \log_3 4$, $x = \log_3 5$, $y = 0$;
 (b) $y = \left(\frac{1}{2}\right)^x$, $x = 0$, $x = 1$, $y = 0$;
 (c) $y = 2^x$, $x = 1$, $x = 5$, $y = x - 1$;
 (d) $y = x + 1$, $y = 3^{-x}$, $x = 2$, $x = 4$.
20. (a) $y = e^x$, $y = e^3$, $x = 0$; (b) $y = e^{-x}$, $y = e^{-4}$,
 $x = 1$; (c) $y = e^{-x}$, $y = x + 1$, $x = 5$;
 (d) $y = |x - 1|$, $x = 2$, $y = e^x$.
21. Find the area of the figure bounded by the curve $y = 9^{-x} + 85$ and the curve $y = k \cdot 3^{-x} + m$ passing through the points $C(0; 34)$ and $D(1; 14)$.
22. Find the area of the figure bounded by the curve $y = 25^x + 16$ and the curve $y = b \cdot 5^x + 4$, whose tangent at the point $x = 1$ is at an angle of $\arctan(40 \ln 5)$ to the x -axis.
23. Find the area of the figure bounded by the curve $y - 15 = e^{2x}$ and the curve $y = 7 \int e^x dx$ passing through the point $A(0, 10)$.

Find the areas of the figures bounded by the following curves:

24. (a) $y = \sin x$, $y = 0$, $x = 0$, $x = 2\pi$;
(b) $y = \sin 3x$, $x = \pi/12$, $x = \pi/6$, $y = 0$;
(c) $y = 2 \cos x$, $x = -\pi/4$, $x = \pi/4$, $y = 0$;
(d) $y = \cos 2x$, $x = -\pi/6$, $x = \pi/8$, $y = 0$.
25. (a) $y = \sqrt{3}/2$, $x = 1$, $y = \cos x$, $x = 0$, $y = 0$;
(b) $y = \sin x$, $y = 0.5$, $y = 0$, $x = 0$, $x = 3$;
(c) $y = \sin x$, $y = 2\sqrt{2}/3$, $x = 0$, $x = \arcsin(2\sqrt{2}/3)$;
(d) $y = 2 - |1 - x|$, $y = \sin x$, $x = 0$, $x = 2$.
26. (a) Find the value of k for which the area of the figure bounded by the curves $x = \pi/18$, $x = k$, $y = \sin 6x$ and the abscissa axis is equal to $1/6$.
(b) At what value of d is the area of the figure bounded by the curves $y = \cos 5x$, $y = 0$, $x = \pi/30$ and $x = d$ equal to 0.2 ?

Calculate the following integrals:

27. (a) $\int_0^2 \sqrt{4-x^2} dx$; (b) $\int_{\sqrt{3}}^2 \sqrt{4-x^2} dx$.
28. $\int_1^2 \ln x dx$. 29. $\int_0^1 \arcsin x dx$.

Chapter 5

PROGRESSIONS AND NUMBER SEQUENCES

5.1. Progressions

1. The first term of the arithmetic progression is unity and the common difference is 4. Is the number 10091 a term of that progression?
2. How many two-digit natural numbers are there which are multiples of 7?
3. Find the sum of all three-digit natural numbers, which, being divided by 5, leave a remainder equal to 4.
4. Find the arithmetic progression if the sum of all its terms, except for the first term, is equal to -36 , the

sum of all its terms, except for the last term, is zero, and the difference of the tenth and the sixth term is equal to -16 .

5. The sum of the first four terms of the arithmetic progression is 56. The sum of the last four terms is 112. Find the progression if its first term is equal to 11.
6. The sum of all terms of the arithmetic progression, except for the first term, is 99, and except for the sixth term, 89. Find the progression if the sum of the first and the fifth term is equal to 10.
7. How many terms of the arithmetic progression should be taken for their sum to equal 91, if its third term is 9 and the difference of the seventh and the second term is 20?
8. All terms of the arithmetic progression are natural numbers. The sum of its nine consecutive terms, beginning with the first, is larger than 200 and smaller than 220. Find the progression if its second term is equal to 12.
9. The sum of the first three terms of the arithmetic progression is 30 and the sum of the squares of the first and the second term of the same progression is 116. Find the first term of the progression if its fifth term is known to be exactly divisible by 13.
10. Find the increasing arithmetic progression, the sum of whose first three terms is 27 and the sum of their squares is 275.
11. The product of the third and the sixth term of the arithmetic progression is 406. The quotient of the division of the ninth term by the fourth term of the progression is equal to 2 and the remainder is -6 . Find the first term and the common difference of the progression.
12. The sum of three numbers is 0.6 (1) and the sum of the reciprocals of those numbers, forming an arithmetic progression, is 18. Determine the numbers.
13. The sum of the first seven consecutive terms of the arithmetic progression is zero and the sum of their squares is a^2 . Find the progression.
14. The product of the second and the twelfth term of the arithmetic progression is equal to unity and the product of the fourth and the tenth term of the same progression is b . Find the seventh term of the progression.
15. The sum of the squares of the fifth and the eleventh term of the arithmetic progression is 3 and the product

- of the second and the fourteenth term of the same progression is k . Find the product of the first and the fifteenth term of the progression.
16. The sum of the squares of the fourth and the tenth term of the arithmetic progression is b and the sum of the squares of the fifth and the ninth term of the same progression is equal to 1. Determine the product of the second and the twelfth term of the progression.
 17. In an arithmetic progression $S_p = q$, $S_q = p$ (S_n being the sum of the first n terms of the progression). Find S_{p+q} .
 18. The sum of the first n terms of the arithmetic progression is equal to half the sum of the next n terms of the same progression. Find the ratio of the sum of the first $3n$ terms of the progression to the sum of its first n terms.
 19. Four different integers form an arithmetic progression. One of these numbers is equal to the sum of the squares of the other three numbers. Find the numbers.
 20. A number of poles lie on the road 10 m from one another. Beginning with one end, a worker transferred all the poles, one by one, to the other end, covering for the purpose a total of 1.44 km. How many poles were there on the road?
 21. Given p arithmetic progressions, each of which consists of n terms. Their first terms are equal, respectively, to 1, 2, 3, . . . , p , and their differences are 1, 3, 5, , $2p - 1$. Find the sum of the terms of all the progressions.
 22. The sixth term of the arithmetic progression is equal to 3, and the common difference exceeds $1/2$. At what value of the difference of the progression is the product of the first, the fourth and the fifth term the largest?
 23. Determine the first term and the common ratio of the geometric progression, the sum of whose first and third terms is 40 and the sum of the second and fourth term is 80.
 24. Determine the sum of the first three terms of the geometric progression, in which the difference between the second and the first term is 6 and the difference between the fourth and the third term is 54.
 25. The sum of the first and the fourth term of the geometric progression is 18 and the sum of the second and

- the third term is 12. Find the difference between the third and the second term of the progression.
26. The sum of the first and the third term of the geometric progression is 20 and the sum of its first three terms is 26. Find the progression.
 27. In a geometric progression, the sum of the first 18 terms exceeds the sum of the first 10 terms by A and the sum of the first seven terms of the same progression, added to the number B , is equal to the sum of the first fifteen terms of the same progression. Find the common ratio of the progression.
 28. In a geometric progression, the sum of the first 109 terms exceeds the sum of the first 100 terms by 12. Find the sum of the first nine terms of the progression if the common ratio is equal to q .
 29. A geometric progression consists of 1000 terms. The sum of the terms occupying the odd places is S_1 and the sum of the terms occupying the even places is S_2 . Find the common ratio.
 30. The sum of the first ten terms of the geometric progression is S_1 and the sum of the next ten terms (11th through 20th) is S_2 . Find the common ratio.
 31. In the increasing geometric progression, the sum of the first and the last term is 66, the product of the second and the last but one term is 128, and the sum of all the terms is 126. How many terms are there in the progression?
 32. Three skaters whose speeds, in a certain order, form a geometric progression, start in a race-course. Some time later, the second skater leaves the first skater behind having run 400 metres more than the first skater. The third skater covers the distance run by the first skater by the time he was overtaken by the second skater in a time interval exceeding by $\frac{2}{3}$ min the time of the first skater. Find the speed of the first skater.
 33. Suppose S_n is the sum of the first n terms of a geometric progression. Prove that $S_n (S_{3n} - S_{2n}) = (S_{2n} - S_n)^2$.
 34. Find the common ratio of an infinitely decreasing geometric progression if its sum is thrice that of its first three terms.
 35. The sum of an infinitely decreasing geometric progression is 3.5 and the sum of the squares of its terms is

- 147/16. Find the sum of the cubes of the terms of that progression.
36. The sum of the second and the eighth term of an infinitely decreasing geometric progression is $325/128$ and the sum of the second and the sixth term, reduced by $65/32$, is equal to the fourth term of that progression. Find the sum of the squares of the terms of the progression.
 37. The difference between the second and the sixth term of an infinitely decreasing geometric progression is $8/(9\sqrt{3})$ and the difference between the fourth and the eighth term is $8/(27\sqrt{3})$. Find the ratio of the sum of the squares of the terms to the sum of the cubes of the terms of the same progression.
 38. The sum of an infinitely decreasing geometric progression is 243 and the sum of its first five terms is 275. Find the progression.
 39. The sum of the terms of an infinitely decreasing geometric progression is equal to the greatest value of the function $f(x) = x^3 + 3x - 9$ on the interval $[-2; 3]$, and the difference between the first and the second term is $f'(0)$. Find the common ratio of the progression.
 40. A certain number is inserted between the number 3 and the unknown number so that the three numbers form an arithmetic progression. If we diminish the middle term by 6, we get a geometric progression. Find the unknown number.
 41. The sum of three positive numbers constituting an arithmetic progression is 15. If we add 1, 4, 19 to those numbers, respectively, we get a geometric progression. Find the numbers.
 42. Three positive numbers form an arithmetic progression. The third number exceeds the first number by 14. If we add the first number to the third and leave the other two numbers unchanged, we obtain a geometric progression. Find the numbers.
 43. The first and the third term of an arithmetic progression are equal, respectively, to the first and the third term of a geometric progression, and the second term of the arithmetic progression exceeds the second term of the geometric progression by 0.25. Calculate the sum of the first five terms of the arithmetic progression if its first term is equal to 2.

44. Find a three-digit number whose consecutive numbers form a geometric progression. If we subtract 792 from this number, we get a number consisting of the same digits written in the reverse order. Now if we increase the second digit of the required number by 2, the digits of the resulting number will form an arithmetic progression.
45. Three numbers form a geometric progression. If we diminish the third term by 64, then the resulting three numbers will form an arithmetic progression. If we then diminish the second term by 8, we get a geometric progression. Determine the numbers.
46. Three numbers constitute a geometric progression. If we add 8 to the second number, then these numbers will form an arithmetic progression; if we then add 64 to the third number, the resulting numbers will again form a geometric progression. Find these three numbers.
47. Three numbers form a geometric progression. If we double the middle number, we get an arithmetic progression. Determine the common ratio of the given progression.
48. The sum of three numbers forming a geometric progression is 124. If we add 1 to the first number and subtract 65 from the third and leave the second number unchanged, the resulting numbers will form an arithmetic progression. Find the indicated progressions.
49. Three numbers whose product is 125 are three consecutive terms of a geometric progression and at the same time the first, the third and the sixth term of an arithmetic progression. Find the numbers.
50. Find the sum of the infinitely decreasing geometric progression whose third term, the triple product of the first term by the fourth and the second term form, in the indicated order, an arithmetic progression with the difference equal to $1/8$.
51. If we add 5, 6, 9 and 15, respectively, to four numbers constituting an arithmetic progression, we get a geometric progression. Find the numbers.
52. If we add 4, 21, 29 and 1, respectively, to four numbers constituting a geometric progression, we get four numbers forming an arithmetic progression. Find the numbers.

53. The sum of the first ten terms of the arithmetic progression is 155 and the sum of the first two terms of the geometric progression is 9. Determine the progressions if the first term of the arithmetic progression is equal to the common ratio of the geometric progression and the first term of the geometric progression is equal to the difference of the arithmetic progression.

5.2. Number Sequences

1. Using the definition of the limit of a number sequence, prove that

$$(a) \lim_{n \rightarrow \infty} \frac{1}{n} = 0; \quad (b) \lim_{n \rightarrow \infty} \frac{n-1}{n+1} = 1;$$

$$(c) \lim_{n \rightarrow \infty} \frac{1}{3^n} = 0.$$

2. Prove that the sequence (x_n) , specified by the formula

$$x_n = \frac{1 + (-1)^n}{n^2} \text{ is bounded.}$$

3. Which of the following sequences $(n \in \mathbb{N})$ are bounded:

$$(a) \frac{1}{3}, -\frac{1}{6}, \frac{1}{9}, \dots, \frac{(-1)^{n+1}}{3n}, \dots; \quad (b) -2, -2, -2, \dots, -2, \dots; \quad (c) 4, \frac{2}{1}, 4, \frac{2}{2}, 4, \frac{2}{3}, \dots, 4, \frac{2}{n}, \dots; \quad (d) 1, -2, 3, -4, \dots, n, -(n+1), \dots; \quad (e) \cos 1^\circ, \cos 2^\circ, \cos 3^\circ, \dots, \cos n^\circ, \dots; \quad (f) 0, 1, 0, 3, 0, 5, \dots, 0, 2n-1, \dots; \quad (g) 1, -2, 4, -8, \dots, (-1)^{n-1} 2^{n-1}, \dots; \quad (h) 2, \frac{4}{3}, \frac{6}{5}, \dots, \frac{2n}{2n-1}, \dots?$$

4. Is every bounded sequence convergent?
 5. Give a definition of an unbounded sequence (without using the prefix "un").
 6. Using the theorem on the limit of the sum of two convergent sequences, prove that

$$(a) \lim_{n \rightarrow \infty} \left(\frac{n+2}{n-1} + \frac{2-3n^2}{n^2+1} \right) = -2;$$

$$(b) \lim_{n \rightarrow \infty} \left(\left(\frac{1}{2} \right)^n + \frac{n-1}{n^2-1} \right) = 0.$$

7. The sequence $(x_n + y_n)$ is known to be convergent. Are the sequences (x_n) and (y_n) convergent?
8. Using the theorem on the limit of the product of two convergent sequences, prove that
- (a) $\lim_{n \rightarrow \infty} \frac{(1+5n^3)(1-n+n^2)}{n^2(n^3+3)} = 5$;
- (b) $\lim_{n \rightarrow \infty} \left(15 + \frac{1}{n^2}\right) \left(\frac{n-7}{n+6}\right) = 15$.
9. The sequence (x_n) is known to be convergent. Prove that the sequence $(-x_n)$ is also convergent, and if $\lim_{n \rightarrow \infty} x_n = a$, then $\lim_{n \rightarrow \infty} (-x_n) = -a$.
10. Given: $\lim_{n \rightarrow \infty} x_n = a$, $\lim_{n \rightarrow \infty} y_n = b$. Prove that $\lim_{n \rightarrow \infty} (x_n - y_n) = a - b$.
11. It is known that the sequence a_n , $n \in \mathbb{N}$, is convergent and the sequence b_n , $n \in \mathbb{N}$, is divergent. What can you say about the convergence of the sequences (a) $a_n + b_n$; (b) $a_n b_n$?
12. The sequences a_n and b_n , $n \in \mathbb{N}$, are divergent. Can you assert that the sequences (a) $a_n + b_n$ and (b) $a_n b_n$ are also divergent?
13. The sequences a_n and b_n , $n \in \mathbb{N}$, are such that $\lim_{n \rightarrow \infty} a_n b_n = 0$. Does it follow that either $\lim_{n \rightarrow \infty} a_n = 0$ or $\lim_{n \rightarrow \infty} b_n = 0$?
14. Which of the following sequences are monotonic:
- (a) $\left(\frac{4n+1}{5n-1}\right)$; (b) $\left((-1)^{n+1} \frac{2n+3}{n+7}\right)$;
- (c) $\left(\frac{6n+4}{3n+2}\right)$; (d) $\left(\frac{4n}{4n+7}\right)$; (e) $(n^{(-1)^n})$;
- (f) $\left(\frac{\sin n}{n}\right)$; (g) $((2 + (-1)^n)n)$; (h) $(4 - 5/3^n)$;
- (i) $(2 + 1/4^n)$?
15. Prove that the sequence $\left(\frac{5n}{n+2}\right)$ is bounded and increasing.
16. Prove that the sequence $\left(\frac{4^n+1}{4^n}\right)$ is bounded and decreasing.

17. The sequence (x_n) converges to zero and the sequence (y_n) is arbitrary. Can we assert that the limit of the sequence $(x_n y_n)$ is zero?

Find the limits of the following sequences:

18. $\lim_{n \rightarrow \infty} \frac{(2n+1)(n-3)}{(n+2)(n+4)}$.
19. $\lim_{n \rightarrow \infty} \frac{5n^3-4}{n^4+6}$. 20. $\lim_{n \rightarrow \infty} \frac{5n^8-n^7+1}{2-3n^8}$.
21. $\lim_{n \rightarrow \infty} \frac{(n+3)^2}{5n^2-n+1}$.
22. $\lim_{n \rightarrow \infty} \frac{3^n(n-2)^2}{3^{n+3}n^2}$. 23. $\lim_{n \rightarrow \infty} \frac{-3n+(-1)^n}{4n-(-1)^n}$.
24. $\lim_{n \rightarrow \infty} \frac{n \sin n}{n^2+1}$. 25. $\lim_{n \rightarrow \infty} \frac{3^{n+1}+4^{n+1}}{3^n+4^n}$.
26. $\lim_{n \rightarrow \infty} \frac{n!}{(n+1)!-n!}$ ($n! = 1 \cdot 2 \cdot 3 \dots (n-1)n$, $1! = 1$, $n \in \mathbb{N}$).
27. $\lim_{n \rightarrow \infty} \frac{(n+3)!+(n+2)!}{(n+4)!}$.
28. $\lim_{n \rightarrow \infty} \frac{3^n-1}{3^n+1}$.
29. $\lim_{n \rightarrow \infty} \frac{1 + \frac{1}{3} + \frac{1}{9} + \dots + \frac{1}{3^n}}{1 + \frac{1}{2} + \frac{1}{4} + \dots + \frac{1}{2^n}}$.
30. $\lim_{n \rightarrow \infty} \frac{3}{n^2} (1 + 2 + 3 + \dots + n)$.
31. $\lim_{n \rightarrow \infty} \frac{4}{n^3} (1^2 + 2^2 + 3^2 + \dots + n^2)$.
32. (a) $\lim_{n \rightarrow \infty} \left(\frac{1}{1 \cdot 2} + \frac{1}{2 \cdot 3} + \frac{1}{3 \cdot 4} + \dots + \frac{1}{n(n+1)} \right)$;
 (b) $\lim_{n \rightarrow \infty} \left(\frac{1}{1 \cdot 3} + \frac{1}{3 \cdot 5} + \frac{1}{5 \cdot 7} + \dots + \frac{1}{(2n-1)(2n+1)} \right)$;
 (c) $\lim_{n \rightarrow \infty} \left(\frac{1}{1 \cdot 2} - \frac{1}{1 \cdot 3} + \frac{1}{2 \cdot 3} - \frac{1}{3 \cdot 5} + \dots + \frac{1}{n(n+1)} - \frac{1}{(2n-1)(2n+1)} \right)$.
33. $\lim_{n \rightarrow \infty} \frac{b^n - b^{-n}}{b^n + b^{-n}}$, $b \neq 0$.

Chapter 6

ELEMENTS OF VECTOR ALGEBRA

6.1. Linear Operations on Vectors

1. What condition should be satisfied by the vectors \mathbf{a} and \mathbf{b} for the following relations to hold true: (a) $|\mathbf{a} + \mathbf{b}| = |\mathbf{a} - \mathbf{b}|$; (b) $|\mathbf{a} + \mathbf{b}| > |\mathbf{a} - \mathbf{b}|$; (c) $|\mathbf{a} + \mathbf{b}| < |\mathbf{a} - \mathbf{b}|$?
2. The nonzero vectors \mathbf{a} , \mathbf{b} and \mathbf{c} are related as $\mathbf{b} = 5\mathbf{a}$ and $\mathbf{c} = -2\mathbf{b}$. Determine (a) the angle between the vectors \mathbf{a} and \mathbf{c} , (b) $|\mathbf{a}| / |\mathbf{c}|$.
3. For what values of x does the inequality $|(x - 2)\mathbf{a}| < |3\mathbf{a}|$ hold true if $\mathbf{a} \neq \mathbf{0}$?
4. Assume $\mathbf{a} \neq \mathbf{0}$. For what values of x do the conditions $|x\mathbf{a}| \geq |\mathbf{a}|$ and $(x\mathbf{a} + 3\mathbf{a}) \uparrow \uparrow \mathbf{a}$ simultaneously hold true?
5. The vectors \mathbf{a} and \mathbf{b} are noncollinear. Find the values of x and y for which the vector equality $2\mathbf{u} - \mathbf{v} = \mathbf{w}$ holds true, if $\mathbf{u} = x\mathbf{a} + 2y\mathbf{b}$, $\mathbf{v} = -2y\mathbf{a} + 3x\mathbf{b}$, $\mathbf{w} = 4\mathbf{a} - 2\mathbf{b}$.
6. Given three nonzero vectors \mathbf{a} , \mathbf{b} and \mathbf{c} , every two of which are noncollinear. Find their sum if the vector $\mathbf{a} + \mathbf{b}$ is collinear with the vector \mathbf{c} and the vector $\mathbf{b} + \mathbf{c}$ is collinear with the vector \mathbf{a} .
7. Given three noncoplanar vectors \mathbf{a} , \mathbf{b} and \mathbf{c} . Find the numbers p and q for which the vectors $p\mathbf{a} + q\mathbf{b} + \mathbf{c}$ and $\mathbf{a} + p\mathbf{b} + q\mathbf{c}$ are collinear.
8. The vectors \mathbf{a} , \mathbf{b} and \mathbf{c} are collinear and $|\mathbf{c}| < |\mathbf{b}| < |\mathbf{a}|$. Is the assertion $(\mathbf{a} + \mathbf{b} + \mathbf{c}) \uparrow \uparrow \mathbf{a}$ true?
9. The points A , B and C are the vertices of a triangle, $\vec{AB} = \mathbf{a}$, $\vec{AC} = \mathbf{b}$. Represent the vector \vec{AO} , where O is the point of intersection of the medians of the triangle, in terms of the vectors \mathbf{a} and \mathbf{b} .
10. The points M and K are the midpoints of the sides $[BC]$ and $[CD]$ of the parallelogram $ABCD$. Find the vector \vec{AC} if $\vec{AM} = \mathbf{a}$ and $\vec{AK} = \mathbf{b}$.
11. What condition should be satisfied by the vectors \mathbf{a} and \mathbf{b} for the vector $\mathbf{a} + \mathbf{b}$ to bisect the angle between the vectors \mathbf{a} and \mathbf{b} ?

12. The points A , B and C are the vertices of a triangle, $\vec{AB} = \mathbf{a}$, $\vec{AC} = \mathbf{b}$, $[AD]$ is the bisector of the triangle. Find the unit vector \mathbf{e} , which is of the same direction as the vector \vec{AD} .
13. Given the points $A(1; 3)$, $B(2; 4)$ and $C(5; 14)$. Find: (a) $|\vec{AB} + \vec{AC}|$; (b) $|\vec{AB} - \vec{AC}|$.
14. At what values of x and y are the vectors $\mathbf{a} = (x; -2; 5)$ and $\mathbf{b} = (1; y; -4)$ collinear?
15. Find the coordinates of the vector \mathbf{p} , collinear with the vector $\mathbf{q} = (3; -4)$, if it is known that the vector \mathbf{p} makes an obtuse angle with the x -axis and $|\mathbf{p}| = 10$.
16. Given three vectors: $\mathbf{a} = (3; -1)$, $\mathbf{b} = (1; -2)$ and $\mathbf{c} = (-1; 7)$. Represent the vector $\mathbf{p} = \mathbf{a} + \mathbf{b} + \mathbf{c}$ in terms of the vectors \mathbf{a} and \mathbf{b} .
17. At what values of x and y are the points with the coordinates $A(2; 0)$, $B(0; 2)$, $C(0; 7)$ and $D(x; y)$ the successive vertices of the isosceles trapezoid $ABCD$?
18. M_1 and M_2 are the midpoints of the segments A_1B_1 and A_2B_2 . Find the vector $\vec{M_1M_2}$ if it is known that $A_1(0; 1; 2)$, $A_2(1; 2; 1)$, $B_1(-1; -1; 3)$ and $B_2(1; 0; 0)$.
19. Given four points: $A(-2; -3; 8)$, $B(2; 1; 7)$, $C(1; 4; 5)$ and $D(-7; -4; 7)$. Prove that the vectors \vec{AB} and \vec{CD} are collinear.
20. The vectors $\vec{AB} = -3\mathbf{i} + 4\mathbf{k}$ and $\vec{AC} = 5\mathbf{i} - 2\mathbf{j} + 4\mathbf{k}$ are the sides of the triangle ABC . Find the length of the median AM .
21. (a) Find the vector $\mathbf{b} = (x; y; z)$, collinear with the vector $\mathbf{a} = (2\sqrt{2}; -1; 4)$ if $|\mathbf{b}| = 10$.
 (b) The vector \mathbf{x} satisfies the following conditions: (1) the vectors \mathbf{x} and $\mathbf{a} = 6\mathbf{i} - 8\mathbf{j} - 7.5\mathbf{k}$ are collinear; (2) the vector \mathbf{x} makes an acute angle with the z -axis; (3) $|\mathbf{x}| = 50$. Find the coordinates of the vector \mathbf{x} .
 (c) The vector \mathbf{b} , collinear with the vector $\mathbf{a} = (3; -4; -12)$, makes an obtuse angle with the x -axis. Find its coordinates knowing that $|\mathbf{b}| = 26$.
22. Find the coordinates of the point M which lies on the x -axis and is equidistant from the points $A(1; 2; 3)$ and $B(-3; 3; 2)$.

23. A triangular pyramid is defined by the coordinates of its vertices $A(3; 0; 1)$, $B(-1; 4; 1)$, $C(5; 2; 3)$ and $D(0; -5; 4)$. Calculate the length of the vector \vec{AO} if O is the point of intersection of the medians of the triangle BCD .
24. Are the vectors $\mathbf{a} = (3/7; 1/2; -3/4)$, $\mathbf{b} = (-3/2; 6; 4/3)$ and $\mathbf{c} = (9/8; -9/2; -1)$ coplanar?
25. Given three vectors: $\mathbf{a} = (3; -2; 1)$, $\mathbf{b} = (-1; 1; -2)$ and $\mathbf{c} = (2; 1; -3)$. Represent the vector $\mathbf{d} = (11; -6; 5)$ in terms of the vectors \mathbf{a} , \mathbf{b} , \mathbf{c} .
26. In the triangular prism $ABCA_1B_1C_1$ the diagonal CB_1 is divided by the point M in the ratio $|CM|/|MB_1| = 2/3$. Represent the vector \vec{AM} in terms of the vectors $\vec{AA_1}$, \vec{AB} and \vec{AC} .
27. Given $|AA_1| = 12$, $|AB| = 3$, $|AD| = 4$ in the rectangular parallelepiped $ABCA_1B_1C_1D_1$. Resolve the unit vector \mathbf{e} , which is of the same direction as $\vec{AC_1}$, with respect to the rectangular basis \mathbf{i} , \mathbf{j} , \mathbf{k} . The unit vectors \mathbf{i} , \mathbf{j} , \mathbf{k} are of the same directions as the vectors \vec{AD} , \vec{AB} and $\vec{AA_1}$ respectively.
28. M_1 and M_2 are the respective points of intersection of the medians of the faces ADB and BDC of the tetrahedron $ABCD$. Find the ratio $|AC|/|M_1M_2|$.
29. Three forces are applied to a vertex of the cube, which are 1, 2 and 3 in magnitude and are directed along the diagonals of the faces of the cube meeting in that vertex. Find the resultant of these three forces.
30. The vector \vec{OM} is defined by the rectangular coordinates of the points $O(0; 0; 1)$ and $M(\alpha; \beta; 3)$. What condition should be satisfied by the parameters α and β for the terminus of the vector \vec{OM} to belong to the sphere $x^2 + y^2 + (z - 1)^2 = 5$?

6.2. The Scalar Product of Vectors

- Determine the angle between the vectors $2\mathbf{a}$ and $\frac{1}{2}\mathbf{b}$, if $\mathbf{a} = (-4; 2; 4)$ and $\mathbf{b} = (\sqrt{2}; -\sqrt{2}; 0)$.
- At what value of z are the vectors $\mathbf{a} = (6; 0; 12)$ and $\mathbf{b} = (-8; 13; z)$ perpendicular?

3. Find the cosine of the angle between the vectors $\mathbf{a} + \mathbf{b}$ and $\mathbf{a} - \mathbf{b}$, if $|\mathbf{a}| = 2$, $|\mathbf{b}| = 1$, $\widehat{(\mathbf{a}, \mathbf{b})} = 60^\circ$.
4. Find the cosine of the angle between the vectors \mathbf{p} and \mathbf{q} satisfying the system of equations
$$\begin{cases} 2\mathbf{p} + \mathbf{q} = \mathbf{a}, \\ \mathbf{p} + 2\mathbf{q} = \mathbf{b}, \end{cases}$$
 if it is known that in a rectangular system of coordinates the vectors \mathbf{a} and \mathbf{b} have the form $\mathbf{a} = (1; 1)$ and $\mathbf{b} = (1; -1)$.
5. Prove that the vector $\mathbf{p} = \mathbf{b}(\mathbf{a}\mathbf{c}) - \mathbf{c}(\mathbf{a}\mathbf{b})$ is perpendicular to the vector \mathbf{a} .
6. The vectors \mathbf{a} , \mathbf{b} and \mathbf{c} are such that $\mathbf{a} + \mathbf{b} + \mathbf{c} = \mathbf{0}$. Calculate $\mathbf{a}\mathbf{b} + \mathbf{b}\mathbf{c} + \mathbf{c}\mathbf{a}$ knowing that $|\mathbf{a}| = 13$, $|\mathbf{b}| = 14$ and $|\mathbf{c}| = 15$.
7. The triangle ABC is defined by the coordinates of its vertices $A(1; 1; 0)$, $B(1; 1; 2)$, $C(3; 3; 1)$. Find the angle of the triangle at the vertex A .
8. The vertices of the triangle are at the points $A(3; -2; 1)$, $B(3; 0; 2)$ and $C(1; 2; 5)$. Find the angle formed by the median BD and the base AC of the triangle.
9. The triangle is defined by the coordinates of its vertices $A(1; 1; 2)$, $B(3; 4; 2)$ and $C(5; 6; 4)$. Find the exterior angle of the triangle at the vertex B .
10. Two vertices of the triangle ABC are defined by the coordinates $A(1; 1; 3)$ and $B(-1; 2; 5)$. The third vertex, the point C , lies on the coordinate axis Oz . Determine the relationship between the degree measure of the angle α at the vertex A and the distance from the point C to the plane Oxy .
11. Three points $A(1; 0)$, $B(0; 1)$ and $C(5; 5)$ are defined on the coordinate plane. Calculate the area of the triangle ABC .
12. The vectors $\overrightarrow{AB} = (3; -2; 2)$ and $\overrightarrow{BC} = (-1; 0; 2)$ are the adjacent sides of a parallelogram. Find the angle between its diagonals \overrightarrow{AC} and \overrightarrow{BD} .
13. Prove that the points $A(2; 4; -4)$, $B(1; 1; -3)$, $C(-2; 0; 5)$ and $D(-1; 3; 4)$ are the vertices of a parallelogram and find the angle between its diagonals.
14. Prove that the points $A(1; -1; 1)$, $B(1; 3; 1)$, $C(4; 3; 1)$ and $D(4; -1; 1)$ are the vertices of a

- rectangle. Calculate the length of its diagonals and the coordinates of their point of intersection.
15. Find the vector \mathbf{b} , which is collinear with the vector $\mathbf{a} = (2; 1; -1)$ and satisfies the condition $\mathbf{a}\mathbf{b} = 3$.
 16. Find the vector \mathbf{c} , knowing that it is perpendicular to the vectors $\mathbf{a} = (2; 3; -1)$ and $\mathbf{b} = (1; -2; 3)$ and satisfies the condition $\mathbf{c}(2\mathbf{i} - \mathbf{j} + \mathbf{k}) = -6$.
 17. Calculate the coordinates of the vector \mathbf{c} , which is perpendicular to the vectors $\mathbf{a} = 2\mathbf{j} - \mathbf{k}$ and $\mathbf{b} = -\mathbf{i} + 2\mathbf{j} - 3\mathbf{k}$ and makes an obtuse angle with the y -axis, if $|\mathbf{c}| = \sqrt{7}$.
 18. Given the vectors $\mathbf{a} = (3; -1; 5)$ and $\mathbf{b} = (1; 2; -3)$. Find the vector \mathbf{c} , provided that it is perpendicular to the z -axis and satisfies the conditions $\mathbf{c}\mathbf{a} = 9$ and $\mathbf{c}\mathbf{b} = -4$.
 19. The vectors \mathbf{a} , \mathbf{b} and \mathbf{c} are of the same length and pairwise form equal angles. Find the coordinates of the vector \mathbf{c} if $\mathbf{a} = \mathbf{i} + \mathbf{j}$, $\mathbf{b} = \mathbf{j} + \mathbf{k}$.
 20. Two points A and B are given in the rectangular Cartesian system of coordinates Oxy on the curve $y = 6/x$ and are such that $\overrightarrow{OA}\mathbf{i} = -2$ and $\overrightarrow{OB}\mathbf{i} = 3$, where \mathbf{i} is a unit vector of the x -axis. Find the length of the vector $2\overrightarrow{OA} + 3\overrightarrow{OB}$.
 21. Find the vector $\mathbf{a} = (x; y; z)$ making equal angles with the vectors $\mathbf{b} = (y; -2z; 3x)$ and $\mathbf{c} = (2z; 3x; -y)$, if the vector \mathbf{a} is perpendicular to the vector $\mathbf{d} = (1; -1; 2)$, $|\mathbf{a}| = 2\sqrt{3}$ and the angle between the vector \mathbf{a} and the y -axis is obtuse.
 22. At what values of x is the angle between the vectors $\mathbf{a} = x\mathbf{i} - 3\mathbf{j} - \mathbf{k}$ and $\mathbf{b} = 2x\mathbf{i} + x\mathbf{j} - \mathbf{k}$ acute and the angle between the vector \mathbf{b} and the axis of ordinates obtuse?
 23. The points M , N , P and Q are located in space so that $(MN) \perp (PQ)$, $(MP) \perp (NQ)$. Prove that $(MQ) \perp (NP)$.
 24. Find the obtuse angle formed by the medians drawn from the vertices of the acute angles of an isosceles right-angled triangle.
 25. Given the vectors $\overrightarrow{AB} = \mathbf{b}$ and $\overrightarrow{AC} = \mathbf{c}$, coinciding with the sides of the triangle ABC . Represent by the components \mathbf{b} and \mathbf{c} the vector applied to the vertex B of that triangle and coinciding with its altitude BM .

26. The triangle ABC is defined by the coordinates of the vertices $A(1; -2; 2)$, $B(1; 4; 0)$ and $C(-4; 1; 1)$. Find the vector \overrightarrow{BM} , where the point M is the foot of the altitude drawn from the vertex B .
27. The tetrahedron $ABCD$ is defined by the coordinates of its vertices $D(1; 0; 0)$, $A(3; -2; 1)$, $B(3; 1; 5)$ and $C(4; 0; 3)$. Find the degree measure of the dihedral angle formed by the lateral face ADC and the plane of the base ABC .
28. Write the equation of the plane passing through three given points $M_1(1; -1; 2)$, $M_2(0; 3; 0)$ and $M_3(2; 1; 0)$.
29. Write the equation of the plane passing through the points $A(4; 0; 0)$ and $B(0; 0; 4)$ parallel to the y -axis.
30. At what value of k do the points $A(1; 0; 3)$, $B(-1; 3; 4)$, $C(1; 2; 1)$ and $D(k; 2; 5)$ lie in the same plane?
31. Given four points: $A(1; -2; 2)$, $B(1; 4; 0)$, $C(-4; 1; 1)$, and $D(-5; -5; 3)$. (a) Prove that these points lie in the same plane; (b) calculate the angle between the straight lines (AC) and (BD) ; (c) determine the area of the quadrilateral $ABCD$.
32. Find the angle between the plane passing through the points $A(0; 0; 0)$, $B(1; 1; 1)$, $C(3; 2; 1)$ and the plane passing through the points A , B and $D(3; 1; 2)$.
33. Given the equations of the planes $2x + 3y + 4z - 8 = 0$ and $4x + y + 3z - 6 = 0$; p is a straight line along which these planes intersect. Determine (a) the coordinates of the points of intersection of the line p and the planes xOy and yOz ; (b) the angle between the line p and the plane xOz .
34. The edge of the cube $ABCD A_1 B_1 C_1 D_1$, $(AA_1) \parallel (BB_1) \parallel (CC_1) \parallel (DD_1)$, is 12 in length. The vertex B of the cube coincides with the origin of the coordinates $Oxyz$, and the points A , C and B_1 lie on the Ox , Oy and Oz axes respectively (in the positive direction). Points E , F_1 and G , taken on the edges $[AA_1]$, $[B_1C_1]$ and $[CD]$, are such that $|AE|/|EA_1| = 1/3$, $|B_1F_1|/|F_1C_1| = 1/4$, $|CG|/|GD| = 1/4$. (a) Determine the coordinates of the points E , F_1 and G ; (b) set up an equation of the plane (EF_1G) ; (c) find the distance between the point B_1 and the plane (EF_1G) .

Chapter 7

PLANE GEOMETRY

7.1. Problems on Proving Propositions

1. M is the midpoint of the interval $[AB]$. Prove that
 $|CM| = \frac{1}{2} ||AC| - |BC||$ if $C \in [AB]$, and
 $|CM| = \frac{|AC| + |BC|}{2}$ if $C \in (AB)$ but $C \notin [AB]$.
2. Five straight lines meeting at a point O are drawn in the plane α . Prove that the sum of the angles, which are not adjacent to each other and have a common vertex O , is equal to π .
3. In the convex quadrilateral $ABCD$, the length of the diagonal AC is equal to that of the side AD . Prove that $|BC| < |BD|$.
4. Prove that in a trapezoid, whose diagonals are the bisectors of the angles at one of the bases, three sides are equal in length.
5. Prove that the midpoints of the sides of a convex quadrilateral are the vertices of a parallelogram.
6. Suppose a and b ($a > b$) are the lengths of the bases of a trapezoid. Prove that the segment connecting the midpoints of the diagonals of the trapezoid is parallel to its bases and the length of the segment is $(a-b)/2$.
7. The bisectors of the interior angles are drawn in a parallelogram. Prove that the points of intersection of the bisectors are the vertices of a rectangle the length of whose diagonal is equal to the difference between the lengths of the neighbouring sides.
8. In the parallelogram $ABCD$, the point M is the midpoint of the side CB , N is the midpoint of the side CD . Prove that the straight lines (AM) and (AN) divide the diagonal BD into three equal parts.
9. Prove that the bisector of the interior angle of a triangle divides the opposite side into segments proportional to the adjacent sides.
10. A straight line, parallel to the bases of the trapezoid, is drawn through the point O of intersection of the diagonals. Prove that the point O bisects the segment inter-

- cepted on the straight line by the nonparallel sides of the trapezoid.
11. Prove that the sum of the distances from any point belonging to a regular triangle to its sides is equal to the length of its altitude.
 12. Suppose p is half the perimeter, S is the area of the triangle, and r is the radius of the inscribed circle. Prove that $r = S/p$.
 13. Assume that a , b and c are the lengths of the sides of a triangle, S is its area, and R is the radius of a circumscribed circle. Prove that $R = abc/(4S)$.
 14. Prove that in a right triangle the sum of the lengths of the legs is equal to the sum of the lengths of the diameters of the inscribed and the circumscribed circle.
 15. Through a point A , lying outside the ring, two straight lines are drawn one of which touches the circle, serving as the boundary of the ring, at a point B , and the other cuts that circle at points C and D , the point C lying between A and D . Prove that $|AD| \cdot |AC| = |AB|^2$.
 16. Prove that any point of a convex quadrilateral belongs to at least one of the circles whose diameters are the sides of the quadrilateral.
 17. A quadrilateral $MNPQ$ is inscribed into a circle, the diagonals of the former being mutually perpendicular and meeting at a point F . A straight line passing through the point F and the midpoint of the side NP cuts the side MQ at a point H . Prove that FH is the altitude of the triangle MFQ .
 18. The squares $ABDE$ and $BCKF$ are constructed on the sides AB and BC of the triangle ABC outside of it. Prove that $|DF| = 2|BP|$, where $[BP]$ is the median of the triangle ABC .
 19. Squares are constructed on the bases AB and CD of the trapezoid $ABCD$, outside of it. Prove that the straight line connecting the centres of the squares passes through the point of intersection of the diagonals of the trapezoid.
 20. Suppose a and b are the lengths of the sides of a parallelogram, and d_1 and d_2 are the lengths of its diagonals. Prove that $d_1^2 + d_2^2 = 2(a^2 + b^2)$.

7.2. Construction Problems

1. Through a point A lying in the interior of the angle, draw a straight line so that the point A would be the midpoint of the segment intercepted on the straight line by the sides of the angle.
2. Construct a triangle if its two sides and the median, all emanating from a common vertex, are given.
3. Points A and B belong to one of the half-planes into which the plane is divided by the straight line p . Find a point on the line p , the sum of whose distances from the points A and B is the least.
4. Construct the bisector of the angle whose vertex lies outside the sheet of paper.
5. A point D is given in the interior of the angle ABC with an unattainable vertex B . Construct the straight line (BD) .
6. Construct the triangle proceeding from its medians.
7. Given two segments a and b in length. Construct the segments whose lengths are (a) \sqrt{ab} ; (b) $\sqrt{a^2 - ab + b^2}$; (c) $\sqrt{a^2 - 2ab + 4b^2}$.
8. Construct a triangle knowing its perimeter and two angles.
9. Inscribe into a given circle a triangle similar to a given triangle.
10. Given a circle with centre at a point O and a point A lying outside the ring bounded by that circle. (a) Construct a tangent to the circle passing through the point A ; (b) through the point A draw a straight line cutting the circle at points B and C so that $|AC| = 2|AB|$ (the point B lies between A and C).
11. Construct three circles, having an external tangency, with centres at the vertices of the given triangle.
12. Points A and B belong to one of the half-planes into which the plane is divided by the straight line p . (a) Construct a circle passing through the points A and B and touching the line p ; (b) find the point $C \in p$ such that the angle ACB is the greatest.
13. Through the given point of the plane lying outside the given angle draw a straight line intercepting a triangle of the specified perimeter on the angle.

7.3. Problems on Calculation

1. In the triangle ABC , the side $|AB| = c = 13$ cm, $|BC| = a = 14$ cm, $|AC| = b = 15$ cm. Determine: (a) the degree measure of the largest interior angle of that triangle; (b) the area S ; (c) the length h_b of the altitude BD ; (d) the length r of the radius of the inscribed circle; (e) the length R of the radius of the circumscribed circle; (f) the length l_b of the bisector BE of the angle B ($E \in [AC]$); (g) the length m_b of the median BF ; (h) the distance between the centres of the inscribed and the circumscribed circle; (i) the distance between the point G of intersection of the medians and the centre of the circumscribed circle.
2. Determine the area of the triangle if its base is a and the angles at the base are equal to 30° and 45° .
3. Given the lengths 6 cm and 3 cm of two sides of a triangle. Find the length of the third side if half the sum of the lengths of the altitudes dropped to the given sides is equal to the length of the third side.
4. In a right triangle the legs are related as 3:2 and the altitude divides the hypotenuse into segments one of which is two metres longer than the other. Find the length of the hypotenuse.
5. In the triangle ABC , $|AB| = |BC|$, the point O is the point of intersection of the altitudes. Find $\angle ABC$ if $|OB| = |AC|$.
6. A circle is inscribed into an isosceles triangle with the vertex angle equal to 120° and a lateral side equal to a . Find the radius of the circle.
7. The centre of the inscribed circle divides the altitude of the isosceles triangle, dropped to the base, into segments 5 cm and 3 cm in length, reckoning from the vertex. Determine the lengths of the sides of the triangle.
8. The inscribed circle touches the hypotenuse of the right triangle at the point dividing the hypotenuse into segments whose lengths are equal to two and three units. Find the radius of the circle.
9. The legs of a right triangle are 15 dm and 20 dm in length. Determine the distance from the centre of the inscribed circle to the altitude dropped to the hypotenuse.

10. Determine the angles of an isosceles triangle knowing that the point of intersection of its altitudes belongs to the inscribed circle.
11. A circle with radius equal to 4 cm is inscribed into a triangle. One of the sides of the triangle is divided by the point of tangency into segments 6 cm and 8 cm in length. Find the lengths of the other sides of the triangle.
12. The lateral side of an isosceles triangle is equal to 10 cm and the base to 12 cm. A circle is inscribed into the triangle and tangents are drawn to it, which are parallel to the altitude of the triangle and intercept on it two small right triangles. Find the lengths of the sides of these triangles.
13. From the centre of the circle inscribed into a triangle with sides equal to 13, 14 and 15 another circle is drawn whose radius is equal to 5. Find the lengths of the chords intercepted by this circle on the sides of the triangle.
14. Find the area of a right triangle if the radius of the inscribed circle is r and the radius of the escribed circle, touching the hypotenuse and the extensions of the legs, is R .
15. In a right triangle, the legs are 75 dm and 100 dm in length. The foot of the altitude drawn from the vertex of the right angle divides the hypotenuse into two segments on which semicircles are constructed on the same side as the given triangle. Determine the lengths of the segments on the legs intercepted between these circles.
16. On the side AB of the triangle ABC a point M is taken such that $|AM|/|MB| = 1/1$. Calculate $|CM|$ if $|AC| = 6$, $|BC| = 4$, $\angle ACB = 120^\circ$.
17. The median drawn to one of the lateral sides of an isosceles triangle divides its perimeter into two parts 15 cm and 6 cm in length. Find the lengths of the sides of the triangle.
18. In the triangle ABC , $|AB| = 2$ cm, $[BD]$ is a median, $|BD| = 1$ cm, $\angle BDA = 30^\circ$. Find the area of the triangle ABC .
19. Find the area of the triangle whose sides are the medians of the triangle with the area equal to S .

20. The legs of a right triangle are b and c in length. Find the length of the bisector of the right angle.
21. In the triangle ABC , $|AB| = 3$ cm, $|AC| = 5$ cm, $\angle BAC = 120^\circ$. Find the lengths of the bisector $[BD]$ and the segments $[AD]$ and $[CD]$.
22. Given in the triangle ABC : $\angle B : \angle C = 1 : 3$. The bisector of the angle BAC divides the area of the triangle in the ratio $2 : 1$. Find the angles of the triangle.
23. In the triangle ABC the angle A is twice the angle B $|AC| = b$, $|AB| = c$. Find $|BC|$.
24. In the right triangle ABC the length of the altitude dropped from the vertex of the right angle to the hypotenuse is a and the length of the bisector of the same angle is b . Find the area of the triangle ABC .
25. In the isosceles triangle ABC , $|AB| = |BC|$, the median AD and the bisector CE are mutually perpendicular. Calculate the angle ADB .
26. In the triangle ABC , $|AC| = 13$ cm, $|AB| + |BC| = 22$ cm, $\angle ABC = 60^\circ$. Find the lengths of the sides $[AB]$ and $[BC]$.
27. The sides of the parallelogram inscribed into a triangle are 3 cm and 4 cm in length and the diagonal is 4 cm. Find the lengths of the sides of the triangle if it is known that the diagonals of the parallelogram are respectively parallel to the lateral sides of the triangle and the smaller side belongs to the base of the triangle.
28. The bisectors of the four angles are drawn in a parallelogram with sides a and b in length and an acute angle α . Find the area of the quadrilateral whose vertices are the points of intersection of the bisectors.
29. Regular triangles are constructed on the sides of the square, in its exterior, and the vertices of the triangles are consecutively connected. Determine the ratio of the perimeter of the resulting quadrilateral to the perimeter of the given square.
30. Find the area of the isosceles trapezoid whose bases are 10 cm and 26 cm in length and the diagonals are perpendicular to the non-parallel sides.
31. One of the angles of the trapezoid is 30° , and the extensions of the nonparallel sides (legs) meet at right angles. Find the smaller leg of the trapezoid if its midline is 10 cm and one of the bases is 8 cm.

32. Find the length of the altitude of the trapezoid if its bases are $a = 28$ cm and $b = 16$ cm, and the non-parallel sides are $c = 25$ cm and $d = 17$ cm.
33. Find the area of the trapezoid whose bases are a and b in length, $a > b$, and the acute angles between the larger base and the non-parallel sides are α and β .
34. An isosceles trapezoid 20 sq cm in area is circumscribed about a circle with radius 2 cm. Find the lengths of the sides of the trapezoid.
35. An isosceles trapezoid $ABCD$ is circumscribed about a circle with radius r ; E and K are the points of tangency of that circle and the non-parallel sides of the trapezoid. The angle between the base AB and the leg AD is 60° . Find the area of the quadrilateral $ABEK$.
36. The centre of the circle inscribed into a right-angled trapezoid is at the distances of 4 cm and 8 cm from the end-points of its leg. Find the length of the midline of the trapezoid.
37. The bases of the isosceles trapezoid are 21 cm and 9 cm in length and the altitude is 8 cm. Determine the radius of the circle circumscribed about the trapezoid.
38. The circle constructed on the base AD of the trapezoid $ABCD$ as a diameter passes through the midpoints of the non-parallel sides AB and CD of the trapezoid and touches the base BC . Find the angles of the trapezoid.
39. The bases of the trapezoid are a and b in length. Find the length of the segment, connecting the non-parallel sides of the trapezoid, which is parallel to the bases and bisects the area of the trapezoid.
40. In the trapezoid $ABCD$, $[AD] \parallel [BC]$, $|AD| = a$, $|BC| = b$, and O is the point of intersection of the diagonals. Find the ratio of the area of the trapezoid to the area of the triangle AOD .
41. Two circles with an external tangency are inscribed into an acute angle of 60° . The radius of the smaller circle is r . Find the radius of the larger circle.
42. The radius of the sector is R and that of the circle inscribed into the sector is r . Calculate the area of the sector.
43. Given two nonintersecting circles with radii R and $2R$. Common tangents are drawn to them which meet at a point A of the segment connecting the centres of the

- circles. The distance between the centres of the circles is equal to $2R\sqrt{3}$. Find the area of the figure bounded by the segments of the tangents, intercepted between the points of tangency, and the larger areas of the circles connecting the points of tangency.
44. The bisector $[AE]$ of the angle A cuts the quadrilateral $ABCD$ into an isosceles triangle ABE ($|AB| = |BE|$) and a rhombus $AECD$. The radius of the circle circumscribed about the triangle ECD is 1.5 times as large as the radius of the circle inscribed into the triangle ABE . Find the ratio of the perimeters of the triangles ECD and ABE .
 45. Inscribed into a semi-circle of radius R are two circles touching each other, the semi-circle and its diameter. The radius of one of them is r in length. Find the radius of the other circle.
 46. The circle inscribed into the triangle ABC touches its sides AC and BC at points M and N respectively and cuts the bisector BD at points P and Q . Find the ratio of the areas of the triangles PQM and PQN if $\angle A = \pi/4$ and $\angle B = \pi/3$.
 47. Two circles with radii $\sqrt{2}$ cm and 1 cm meet at a point A . The distance between their centres is 2 cm. The chord $[AC]$ of the larger circle cuts the smaller circle at a point B and is bisected by that point. Find the length of the chord $[AC]$.
 48. The diagonals of the convex quadrilateral make a right angle, and the sum of their lengths is 6 cm. What is the largest possible value of the area of the quadrilateral?
 49. At what value of the length of the altitude does the right-angled trapezoid, with an acute angle of 45° and the perimeter of 4 cm, have the largest area?
 50. In the isosceles triangle ABC the angle at the base AC is α , and the lateral side is a in length. The point D is on the altitude BM and the sum of the squares of its distances from the points A , B and C is the least as compared to the other points of the segment BM . Find the length of the segment MD .
 51. Two sides of the parallelogram lie on the sides of the given triangle, and one of its vertices belongs to the third side. Under what conditions is the area of the parallelogram the largest?

Chapter 8

SOLID GEOMETRY

8.1. A Straight Line, a Plane, Polyhedra. Solids of Revolution

1. Two right triangles lie in the mutually perpendicular planes and have a hypotenuse in common. Find the distance between the vertices of the right angles of the triangles if the legs of the triangles are 4 cm and 3 cm in length.
2. Given a dihedral angle φ in magnitude. From a point of its edge in one of its faces a segment is drawn making an angle ψ with that edge. What angle does the segment make with the plane of the other face?
3. The legs AB and AC of a right triangle belong to the faces α and β of an acute dihedral angle and make acute angles φ and ψ , respectively, with the edge of the dihedral angle. Determine the magnitude of the dihedral angle.
4. The vertices A and B of the rectangle $ABCD$ are at a distance $8l$ each from the plane γ , and the midpoint M of the side $[CD]$ belongs to the plane γ . The diagonals AC and BD of the rectangle meet at a point O . Find the distance from the centre of the circle circumscribed about the triangle AOB to the plane γ if $\angle ADB = \varphi$.
5. The vertices A and B of the regular triangle ABC are at a distance h and the point C is at a distance equal to m ($h > m$) from a certain plane β . At what distance from the plane β is the centre of the circle inscribed into the triangle ABC ?
6. The diagonal of the rectangular parallelepiped is equal to l and makes an angle equal to α with the plane of the base. Find the area of the lateral surface of the parallelepiped if the area of its base is S .
7. The angle between the diagonals of the base of the rectangular parallelepiped is equal to α . The diagonal of the parallelepiped makes an angle β with the plane of the base. Find the altitude of the parallelepiped if its volume is V .
8. The bases of the parallelepiped are squares with a side b , and all the lateral faces are rhombi. One of the ver-

- tices of the upper base is equidistant from all the vertices of the lower base. Find the volume of the parallelepiped.
9. Given the cube $ABCD A_1 B_1 C_1 D_1$. M is the midpoint of the edge $A_1 B_1$ and the point N is the centre of the face $ABB_1 A_1$. Calculate the angle between the lines MD and CN .
 10. Given the cube $ABCD A_1 B_1 C_1 D_1$. Calculate the angle between the planes (BCB_1) and $(BC_1 M)$, where M is the midpoint of the edge AD .
 11. The edge of the cube $ABCD A_1 B_1 C_1 D_1$ is a in length. P is the midpoint of the edge CC_1 , the point Q is the centre of the face $AA_1 B_1 B$. The segment MN with its endpoints on the lines AD and $A_1 B_1$ cuts the line PQ and is perpendicular to it. Find the length of the segment.
 12. The diagonal of the lateral face of a regular triangular prism, equal to l makes an angle β with the plane of the other lateral face. Find the volume of the prism.
 13. An isosceles triangle with the vertex angle α and the perimeter equal to p serves as the base of a right prism. The angle between the diagonals of congruent (equal) lateral faces of the prism, drawn from the same vertex, is equal to β . Find the volume of the prism.
 14. A plane is drawn through the side of the lower base of a regular triangular prism and the opposite vertex of the upper base at an angle α to the plane of the base. The area of the section of the prism formed by the plane is equal to S . Find the volume of the cut-off triangular pyramid.
 15. Given the regular triangular prism $ABCA_1 B_1 C_1$, with $|BB_1| = 2|AC|$. The points E and F are the centres of the faces $AA_1 B_1 B$ and $CC_1 B_1 B$. The point P is the centre of the base ABC and the point Q is the midpoint of the edge CC_1 . Calculate the angle between the lines EF and PQ .
 16. The sides of the base of the regular triangular prism $ABCA_1 B_1 C_1$ are a in length. The vertices M and N of the regular tetrahedron $MNPQ$ lie on the straight line passing through the points C_1 and B , and the vertices P and Q lie on the line $A_1 C$. Find the volume of the prism.
 17. The length of the side of the base of the regular triangular prism $ABCA_1 B_1 C_1$ is 3 and the altitude is $4\sqrt{3}$. The vertex of the regular tetrahedron belongs to the segment connecting the centres of the faces ABC and $A_1 B_1 C_1$.

The plane of the base of the tetrahedron coincides with that of the face ABC of the prism, and the plane of one of its lateral faces passes through the diagonal AB_1 of the lateral face of the prism. Find the length of the edge of the tetrahedron.

18. The side of the base ABC of the regular triangular prism $ABCA_1B_1C_1$ is a . M and N are the midpoints of the edges AC and A_1B_1 respectively. The projection of the segment MN onto the line (BA_1) is equal to $a/2\sqrt{6}$. Determine the altitude of the prism.
19. The length of each edge of the tetrahedron $SABC$ is a . Find the distance between (SA) and (BC) .
20. Find the volume of the regular triangular pyramid whose lateral edge makes an angle α with the plane of the base and is at the distance k from the middle of the opposite side of the base.
21. The angle between the altitude of the regular triangular pyramid and the apothem of the pyramid is α and the length of the lateral edge of the pyramid is l . Find the volume of the pyramid.
22. A perpendicular equal to b is dropped from the foot of the altitude of a regular triangular pyramid to its lateral face. Find the volume of the pyramid if the angle of inclination of the lateral edge to the plane of the base is α .
23. Find the total surface of a regular triangular pyramid from its given volume V and the angle α of inclination of the lateral face to the plane of the base.
24. The base of a triangular pyramid whose all lateral faces make the angle α with the plane of the base is a regular triangle whose side is a in length. Find the volume of the pyramid.
25. The bases of the truncated triangular pyramid $ABCA_1B_1C_1$ are regular triangles whose sides are a and b in length ($a > b$). The lateral faces make the angle α with the plane of the lower base. Find the volume of the polyhedron AB_1C_1CB .
26. The base of the pyramid $SABC$ is a regular triangle whose side is a in length. The edge SA is perpendicular to the plane of the base. The lateral face SBC is at an angle φ to the plane of the base. Determine the area of the lateral surface of the pyramid if one of its lateral faces is taken to be its base.

27. Given the regular triangular pyramid $SABC$. A plane, perpendicular to the lateral edge SA , is drawn through the vertex C of the base of the pyramid. That plane makes an angle whose cosine is equal to $2/3$ with the plane of the base. Find the cosine of the angle between the lateral faces.
28. The line segment connecting the centre of the base of a regular triangular pyramid with the midpoint of a lateral edge is equal to the side of the base. Find the angle between the adjacent lateral faces of the pyramid.
29. (a) In the trihedral angle $SABC$, $\angle ASB = \beta$, $\angle ASC = \gamma$, $\angle BSC = \alpha$. The measure of the dihedral angle at the edge AS is that of the angle A . Prove that $\cos \alpha = \cos \beta \cos \gamma + \sin \beta \sin \gamma \cos A$ (the cosine theorem for a trihedral angle); (b) find the magnitude of the dihedral angle between the lateral faces of a regular triangular pyramid if the magnitude of the dihedral angle between a lateral face and the base is equal to φ .
30. The altitude of a regular triangular pyramid is h in length, and the magnitude of the dihedral angle formed by the lateral faces is 2φ . Find the volume of the pyramid.
31. A plane cuts a triangular pyramid into two polyhedra. Find the ratio of the volumes of the polyhedra if it is known that the secant plane divides three edges emanating from the same vertex of the pyramid in the ratios $1 : 2$, $1 : 2$ and $2 : 1$, reckoning from the vertex.
32. The volume of a regular triangular pyramid is $1/6$ of the volume of the cube, the length of whose edge is equal to that of the lateral edge of the pyramid. Find the plane angle at the vertex of the pyramid.
33. The lateral edges of a regular quadrangular pyramid are equal to a and make an angle α with the plane of the base. Find the area of the lateral surface and the volume of the pyramid.
34. The side of the base of the regular quadrangular pyramid $SABCD$ is equal to 2 and the altitude is $\sqrt{2}$. Find the distance between the lateral edge SA and the diagonal BD of the base.
35. Find the volume of a regular quadrangular pyramid, the side of whose base is a and the dihedral angle between the lateral faces is equal to α .

36. Find the volume of a regular quadrangular pyramid the length of whose lateral edge is equal to l and the dihedral angle formed by two opposite faces is equal to β .
37. In a regular quadrangular pyramid the side of the base is a in length and the vertex plane angle is equal to the angles of inclination of the lateral edges to the plane of the base. Find the volume of the pyramid.
38. The base of the pyramid $MABCD$ is a rhombus $ABCD$, whose diagonal $[AC]$ is a in length. The straight line (DM) makes an angle α with the plane of the base of the pyramid, and $|DM| = k$. Find the area of the total surface of the cube whose volume is equal to that of the given pyramid, if it is known that the angle between the lines (DM) and (MB) is equal to γ and $\angle MBC = \angle ABM$.
39. The base of the pyramid is a rhombus whose diagonals are 6 m and 8 m in length. The altitude of the pyramid passes through the point of intersection of the diagonals of the rhombus and is 1 m in length. Find the area of the lateral surface of the pyramid.
40. The base of the pyramid $SABCD$ is a square. The edge SA is perpendicular to the base. The area of the base is m times as small as the lateral surface. Find the angles of inclination of the faces SCD and SBC to the plane of the base.
41. The base of the quadrangular pyramid $SABCD$ with vertex S is a rhombus and the altitude SO of the pyramid passes through the point of intersection of the diagonals of the rhombus. Calculate the dihedral angle formed by the lateral face SAB and the base of the pyramid if $\angle ASO = \alpha$ and $\angle BSO = \beta$.
42. The dihedral angle at the lateral edge of a regular quadrangular pyramid is equal to α . Calculate the angle between the lateral face of the pyramid and the plane of the base.
43. In the regular quadrangular pyramid $SABCD$, the angle between the lateral edge SA and the plane of the base $ABCD$ is equal to the angle between the edge SA and the plane of the face SBC . Calculate that angle.
44. When the lateral surface of a cylinder is developed, it becomes a rectangle whose diagonal is equal to a and makes an angle α with the base. Find the volume of the cylinder.

45. The plane passing through the centre of the lower base of the cylinder at an angle α° to the plane of the base cuts the upper base along the chord, b in length, subtending the arc of β° . Find the volume of the cylinder.
46. The area of the total surface of the cone is S and the angle at the vertex of the axial section is α . Find the volume of the cone.
47. A regular triangle, whose side is a in length, is inscribed into the base of a cone. The section formed by the plane, passing through the vertex of the cone and a side of the triangle, and the surface of the cone is a regular triangle. Find the volume of the cone.
48. A plane drawn through the vertex of the cone cuts its base along the chord whose length is equal to the radius of the base. Determine the ratio of the volumes of the resulting portions of the cone.
49. A section is drawn in a given cone through its vertex and at an angle β to the plane of its base. The plane of the section is at a distance a from the centre of the base of the cone. Determine the total surface of the cone if the greatest angle between the generating lines of the cone is equal to α .
50. Given the right triangular prism $ABCA_1B_1C_1$ in which $|AC| = 6$, $|AA_1| = 8$. A plane is drawn through the vertex A cutting the edges BB_1 and CC_1 at points M and N respectively. In what ratio does the plane divide the volume of the prism if it is known that $|BM| = |MB_1|$ and AN is the bisector of the angle CAC_1 ?

8.2. Problems on Combinations of Polyhedra and Solids of Revolution

1. The volume of a regular triangular prism is equal to V . A plane, cutting off a pyramid of volume W from the prism, is drawn through the vertex of the base, parallel to the opposite edge of that base, at an angle α to the plane of the base. Find the altitude of the prism if $V > 3W$.
2. A cube, with an edge equal to a , is inscribed into a regular quadrangular pyramid so that its four vertices are on the lateral edges and the other four vertices are on the base of the pyramid. The lateral faces of

the pyramid make an angle α with the plane of the base. Determine the volume of the pyramid.

3. The base of the pyramid $SABC$ is an isosceles triangle ABC , $|AB| = |AC| = a$, $\angle ABC = \varphi$. The straight line (AS) makes an angle α with the plane of the base of the pyramid, the plane of the lateral face (BSC) makes an angle β with the same plane, and $\angle SAC = \angle SAB$. Find the volume of the pyramid $KSLC$ if it is known that the points K and L belong to the edges $[AS]$ and $[BS]$ respectively and the area of the triangle KSL is in the ratio of 4 : 25 with the area of the triangle ABS .
4. A cylinder is inscribed into a regular quadrangular pyramid with the vertex plane angle α , the lower base of the cylinder lying in the plane of the base of the pyramid and the circumference of the upper base touching the lateral faces of the pyramid. Find the volume of the pyramid if it is known that the altitude of the cylinder is half that of the pyramid and the radius of the base is equal to r .
5. Determine the area of the lateral surface of the cone inscribed into a regular triangular pyramid if the lateral edge of the pyramid is l in length and the lateral face of the pyramid makes an angle α with the plane of the base.
6. Find the volume of the cone inscribed into a regular triangular pyramid with a lateral edge l and the vertex plane angle α .
7. A truncated cone is inscribed into a regular triangular truncated pyramid with the base dihedral angle α . Determine the lateral surface of the cone if the apothem of the lateral face of the pyramid is equal to the sum of the radii of the bases of the cone and the radius of the smaller base of the cone is equal to r .
8. The base of the pyramid is a rhombus with a side a and the acute angle α . A cone whose generatrix is at an angle φ to the plane of the base, is inscribed into the pyramid. Find the volume of the cone.
9. A right prism whose base is a rhombus is circumscribed about a sphere. The longer diagonal of the prism makes an angle with the plane of the base which is equal to α . Calculate the acute angle of the rhombus.

10. In the rectangular parallelepiped the lateral edge is c in length and the sides of the rectangle serving as the base are a and b in length. Through one of the vertices of the upper base of the parallelepiped and the opposite vertex of the lower base a plane is drawn parallel to the diagonal of the rectangle serving as the base. Find the radius of the sphere touching the indicated plane and the plane of the lower base of the parallelepiped at the point of intersection of its diagonals.
11. In a regular triangular pyramid, the vertex plane angle is equal to α and the altitude of the pyramid is h in length. Find the radius of the sphere circumscribed about the pyramid.
12. The base of the triangular pyramid, whose altitude is equal to h , is a right triangle with a leg equal to a and the acute angle adjacent to that leg equal to α . The vertex of the pyramid is mapped into the vertex of the right angle of the triangle. Find the radius of the sphere circumscribed about the pyramid.
13. Determine the volume of the ball circumscribed about a regular triangular pyramid the side of whose base is equal to a and the lateral edges make an angle α with the plane of the base.
14. The base of the pyramid is a rectangle with the angle α between the diagonals. The lateral edges are at an angle φ to the plane of the base. Find the volume of the pyramid if the radius of the circumscribed ball is R . The centre of the ball is outside the pyramid.
15. Find the altitude of a regular quadrangular pyramid if it is known that the volume of the ball circumscribed about the pyramid is equal to V and the perpendicular dropped from the centre of the ball to its lateral face makes an angle α with the altitude of the pyramid. The centre of the ball is inside the pyramid.
16. The radius of the ball circumscribed about a regular quadrangular pyramid is in the ratio $3 : 4$ with the side of the base of the pyramid. Calculate the angle between the lateral face and the plane of the base of the pyramid.
17. The base of the pyramid $SABCD$ is a rectangle $ABCD$ in which $(AB) \parallel (CD)$, $(BC) \parallel (AD)$, $|AB| = 3$, $|BC| = 4$. All the lateral edges of the pyramid make equal angles with the plane of the base. Calculate the

angle between the lines (BS) and (CS) if the radius of the sphere circumscribed about the pyramid is equal to 6.5.

18. The base of the pyramid is an isosceles triangle whose lateral sides are equal to b and the angle between them is equal to α . Two lateral faces of the pyramid passing through equal (congruent) sides of the base are perpendicular to the base and the third face is at an angle α to the base. Find the radius of the ball inscribed into the pyramid.
19. The altitude of a regular triangular pyramid is h in length and the radius of the circle inscribed into the base of the pyramid is equal to r . A secant plane is drawn through the midpoints of two sides of the base and the vertex of the pyramid. Find the radius of the sphere touching the base of the pyramid at the point of intersection of its medians and the secant plane.
20. Each edge of the tetrahedron is 1 in length. Find the radius of the sphere touching all the planes of the faces of the tetrahedron.
21. The base of the pyramid is a rhombus with a side a and the acute angle α . Each base dihedral angle is equal to φ . Find the volume of the ball inscribed into the pyramid.
22. The side of the base of a regular quadrangular pyramid is equal to a and the vertex plane angle is equal to α . Find the area of the surface of the sphere inscribed into the pyramid.
23. The angle between the planes of the base and of the lateral face of a regular quadrangular pyramid is equal to β and the area of the sphere inscribed into the pyramid is equal to S . Find the area of the lateral surface of the pyramid.
24. In a regular quadrangular pyramid each vertex plane angle is equal to β and the radius of the ball touching all the five planes of the faces of the pyramid is equal to R . Find the volume of the pyramid.
25. A regular quadrangular truncated pyramid is circumscribed about a ball, the sides of the base of the pyramid being in the ratio $m : n$. Determine the ratio of the volumes of the pyramid and the ball.
26. Find the length of the radius of the ball touching the base and the lateral edges of a regular quadrangular

- pyramid in which the side of the base is a in length and the vertex plane angle is equal to 2β .
27. A ball with radius R is inscribed into a cone. From the centre of the ball the generatrix of the cone is seen at an angle α . Find the volume of the cone.
 28. The sphere touches the plane of the base of a right circular cone at its centre. The plane making an angle γ with the altitude of the cone touches the sphere and intercepts on the circumference of the base an arc with an acute central angle α . Find the radius of the sphere if the radius of the circumference of the base of the cone is r .
 29. Find the ratio of the volume of a right circular cone to that of the ball inscribed into the cone if it is known that the generatrix of the cone makes an angle α with the plane of the base of the cone.
 30. Find the angle between the generatrix and the base of the truncated cone whose total surface is twice the surface of the ball inscribed into it.
 31. A truncated cone is circumscribed about a ball, the area of the lower base of the cone being a times as large as the area of its upper base. How many times is the volume of the truncated cone greater than the volume of the ball?
 32. The ratio of the altitude of the cone to the radius of the ball circumscribed about it is equal to q . Find the ratio of the volumes of these solids.
 33. A ball is inscribed into a regular quadrangular pyramid. The apothem of the pyramid, equal to l makes an angle α with the base of the pyramid. A cylinder is inscribed into the ball. Determine the ratio of the volume of the pyramid to that of the cylinder if the altitude of the cylinder is equal to double the radius of its base.
 34. A regular triangular pyramid is inscribed into a ball so that the plane of the base of the pyramid divides the radius of the ball perpendicular to it in the ratio $3 : 7$, reckoning from the centre of the ball. Find the volume of the cone inscribed into the pyramid. The radius of the ball is equal to R .
 35. A regular quadrangular pyramid is inscribed into a sphere of radius R , the base of the pyramid bisecting

- the radius perpendicular to it. Determine the area of the surface of the sphere inscribed into the pyramid.
36. A right triangle ABC serves as the base of a right prism. The radius of the circle circumscribed about it is equal to r and the leg AC subtends an arc equal to $2\beta^\circ$. Through the diagonal of the lateral face passing through the other leg BC a plane is drawn at right angles to that face, forming an angle β° with the plane of the base. Determine the area of the section.
 37. The base of a right prism is a rhombus with the acute angle α , the altitude of the prism being longer than the longer diagonal of the base. At what angle to the plane of the base must we draw a secant plane to obtain a square in the section?
 38. An isosceles trapezoid with the acute angle α circumscribed about a circle with radius r serves as the base of a right prism. Through the lateral side of the lower base and the opposite vertex of the acute angle of the upper base a plane is drawn forming a dihedral angle equal to β with the plane of the lower base. Determine the area of the section of the prism formed by that plane.
 39. In the regular triangular pyramid $SABC$ the side of the base ABC is equal to a and the vertex plane angle is equal to α . Find the area of the section drawn through the vertex S parallel to the edge $[AB]$ and forming an angle γ with the plane of the base ABC .
 40. The apothem of a lateral face of a regular triangular pyramid is k in length. The pyramid is cut by a plane equidistant from all its vertices. Find the area of the resulting section if the lateral edge of the pyramid makes an angle β with the plane of its base.
 41. A lateral edge of a regular quadrangular pyramid is l in length and the angle between the plane of a lateral face and the plane of the base is equal to β . The pyramid is cut by a plane equidistant from all its vertices. Find the area of the resulting section.
 42. The side of the base of a regular quadrangular pyramid is a in length and its lateral edge makes an angle α with the plane of the base. The pyramid is cut by a plane passing through a vertex of the base at right angles to the lateral edge emanating from the opposite vertex of the base. Find the area of the section.

43. A lateral face of a regular quadrangular pyramid is at an angle α to the base. The radius of the sphere inscribed into the pyramid is equal to r . Find the area of the section of the pyramid passing through the centre of the inscribed sphere parallel to the base of the pyramid.
44. In the regular quadrangular pyramid $SABCD$ the side of the base $ABCD$ is a in length and the altitude is $2a\sqrt{2}$ in length. A plane is drawn through the vertex A parallel to the diagonal BD of the base of the pyramid so that the angle between the line AB and that plane is equal to $\pi/6$. Find the area of the section.
45. The base of the regular quadrangular pyramid $SABCD$ is a square $ABCD$ whose side is a in length. The planes of the lateral faces make an angle α with the plane of the base of the pyramid. Points E and F are taken on the sides AD and BC such that $|AE| = 2a/3$ and $|CF| = a/3$. The plane drawn through those points makes an angle β with the plane of the base. Find the area of the resulting section.
46. Among all regular triangular prisms with the volume V find the prism with the least sum of the lengths of all the edges. How long is the side of the base of that prism?
47. A cylinder is inscribed into a cone with the altitude H and the radius of the base R so that one of its bases lies in the plane of the base of the cone and the circumference of the other base belongs to the lateral surface of the cone. What should the altitude of the cylinder be for the volume to be the largest? Find that greatest value of the volume.
48. Find the radius r of the base and the altitude h of the right circular cone inscribed into a sphere with radius R so that its volume is the greatest.
49. Find a cone of the least volume circumscribed about a ball with radius R .
50. Find the altitude of the cone of the least volume circumscribed about a half-ball with radius R (the centre of the base of the cone is at the centre of the ball).
51. A regular quadrangular pyramid is inscribed into a sphere with radius R so that all its vertices belong to the sphere. What should the altitude of the pyramid be for its volume to be the greatest? Find that greatest value of the volume.

52. A regular hexagonal prism is inscribed into a cone with the altitude H and the radius of the base R , so that one of its bases lies in the plane of the base of the cone and the vertices of the other base belong to the lateral surface of the cone. What should the altitude of the prism be for its volume to be the greatest? Find that greatest value of the volume of the prism.
53. The angle between a lateral edge and the altitude of a regular triangular pyramid is equal to φ . A cylinder is inscribed into the pyramid whose radius and the altitude are of the same length r . One of the bases of the cylinder has one point in common with each lateral face of the pyramid and the other base lies in the plane of its base. At what value of φ is the volume of the pyramid the smallest?
54. A regular triangular pyramid is inscribed into a right circular cone, the apothem of the lateral face of the pyramid being equal to k in length and the lateral face itself making an angle α with the plane of the base. Through one of the lateral edges of the pyramid a plane is drawn cutting the conical surface. Find the area of the section of the cone formed by that plane if it is known that that area is of the greatest value possible.

8.3. Volumes of Solids of Revolution

1. A triangle rotates about the side which is a in length. Determine the volume of the solid of revolution if the adjacent angles are equal to α and β .
2. Two isosceles triangles ABC and ADC lie on the same side of the common base AC equal to b . Find the volume of the solid produced by the rotation of the figure $ABCD$ about the base AC if $\angle ACB = \alpha$, $\angle ACD = \beta$ ($\alpha > \beta$).
3. The smaller side of the parallelogram is a in length, the acute angle of the parallelogram is equal to α and the angle between the smaller diagonal and the larger side is equal to β . Find the volume of the solid produced by rotating a parallelogram about its larger side.
4. The figure bounded by the area of the parabolas $y = x^2$ and $y^2 = x$ rotates about the abscissa axis. Calculate the volume of the resulting solid.

5. Find the volume of the figure resulting from rotation about the axis of ordinates of a curvilinear trapezoid whose boundary is defined by the equations $y^2 = x$, $y = 0$, $y = 1$ and $x = 0$.
6. Find the volume of the figure resulting from rotation about the axis of abscissas of a curvilinear trapezoid whose boundary is defined by the equations (a) $y = |x - 1| - 2$, $x = 0$, $x = 3$, $y = 0$; (b) $y = |x - 1| - |x + 1|$, $x = -2$, $x = 2$, $y = 0$; (c) $y = x|x - 2|$, $x = 0$, $x = 3$, $y = 0$; (d) $y = \frac{x^2 - 3|x| + 2}{x}$, $x = -1$, $x = 2$, $y = 0$; (e) $y = \sqrt{1-x}$, $x = -3$, $x = 1$, $y = 0$.
7. The square rotates about an axis lying in its plane and passing through only one of its vertices. At what position of the square relative to the axis is the volume of the resulting solid of revolution the greatest?

Chapter 9

MISCELLANEOUS PROBLEMS

9.1. Problems in Algebra

1. Given two sets: $M_1 = \{1, 2\}$ and $M_2 = \{a, 5\}$, $a \in \mathbb{R}$. Find the sets $A = M_1 \cup M_2$ and $B = M_1 \cap M_2$.
2. Prove that the product of three successive natural numbers is a multiple of 6.
3. Prove that the number 1110987654312 cannot be a square of an integer.
4. Suppose m and n are coprime natural numbers ($n > m$). Find the greatest common divisor, different from unity, of the numbers $3n - m$ and $5n + 2m$ if it is known to exist.
5. There are young men and women in a group of gymnasts, the men constituting more than 94%. What can be the smallest number of gymnasts in the group?
6. Prove that $\log_2 5$ is not a rational number.
7. Suppose a , b and c are integers. Determine the sign of a if it is known that the numbers $(-6)^{2n+2}a^{2n+3}b^{2n-1}c^{n+5}$ and $(-7)^{2n+1}a^n b^{2n+1}c^{n-3}$, $n \in \mathbb{N}$ are of the same sign.
8. Calculate $a^4 + b^4 + c^4$ knowing that $a + b + c = 0$ and $a^2 + b^2 + c^2 = 1$.

9. Prove that

(a) $1^2 + 2^2 + 3^2 + \dots + n^2 = \frac{n(n+1)(2n+1)}{6}$, $n \in \mathbb{N}$;

(b) $\frac{1}{2} + \frac{2}{2^2} + \frac{3}{2^3} + \dots + \frac{n}{2^n} = 2 - \frac{n+2}{2^n}$, $n \in \mathbb{N}$.

10. Find the sum

(a) $S_n = 1 + 3 + 6 + \dots + \frac{n(n+1)}{2}$, $n \in \mathbb{N}$;

(b) $S_n = 1^3 + 2^3 + 3^3 + \dots + n^3$, $n \in \mathbb{N}$.

11. The product of two positive numbers is equal to unity. Prove that the sum of those numbers is not smaller than 2.

12. The product of n positive numbers is equal to unity. Prove that the sum of those numbers is not smaller than n .

13. Suppose $x_1, x_2, x_3, \dots, x_n$ are positive numbers.

Prove that $\frac{x_1 + x_2 + x_3 + \dots + x_n}{n} \geq \sqrt[n]{x_1 x_2 x_3 \dots x_n}$.

14. Prove the inequality $n! < \left(\frac{n+1}{2}\right)^n$, $n \in \mathbb{N}$, $n \geq 2$.

15. Suppose $x_1, x_2, x_3, \dots, x_n$ ($n \in \mathbb{N}$) are numbers of the same sign exceeding -1 . Prove that $(1 + x_1) \times (1 + x_2) \dots (1 + x_n) \geq 1 + x_1 + x_2 + \dots + x_n$.

16. Prove the inequality: (a) $\frac{1}{2} \cdot \frac{3}{4} \cdot \frac{5}{6} \dots \frac{99}{100} < \frac{1}{10}$;

(b) $\frac{1}{2} \cdot \frac{3}{4} \cdot \frac{5}{6} \dots \frac{2n-1}{2n} \leq \frac{1}{\sqrt{3n+1}}$, $n \in \mathbb{N}$;

(c) $\frac{1}{2} \cdot \frac{3}{4} \cdot \frac{5}{6} \dots \frac{99}{100} < \frac{1}{12}$.

17. Prove that for any natural $n > 1$ the following inequality holds true:

$$\frac{1}{n+1} + \frac{1}{n+2} + \dots + \frac{1}{n+n} > \frac{13}{24}.$$

18. Prove that $|\sin n\alpha| \leq n |\sin \alpha|$ for any $n \in \mathbb{N}$.

19. Prove that (a) $\tan(-314^\circ) > \frac{61}{59}$; (b) $\ln \frac{5}{7} < \frac{11}{30}$.

20. Suppose D_1 and D_2 are the domains of definition of the functions $f_1(x)$ and $f_2(x)$ respectively. (a) Find the domain D of the function $f(x) = f_1(x) + f_2(x)$; (b) Under what condition is the equality $D = D_1 \cup D_2$ satisfied for the domain of the function $f(x)$?

21. Find the value of $f(2)$ if the equality $2f(x) - 3f(1/x) = x^2$ is satisfied for any $x \neq 0$.
22. What curve is the graph of the function $y = f(f(f(x)))$ if $f(x) = 1/(1-x)^2$?
23. Given the graph of the function $y = f(x)$ (see p. 269, Fig. 23). Construct the graph of the function (a) $y = |f(x)|$;
 (b) $y = \frac{1}{2}(|f(x)| + f(x))$; (c) $y = \frac{1}{2}(|f(x)| - f(x))$;
 (d) $y = f(|x|)$, (e) $y = f(-|x|)$.
24. The function $f(x)$ increases on the interval $(a; b)$. Can we assert that the function $\varphi(x) = f^2(x)$ increases on the same interval?
25. The functions $f_1(x)$ and $f_2(x)$ are decreasing on the interval $(a; b)$. Prove that the function $\varphi(x) = f_1(x) + f_2(x)$ decreases on the interval $(a; b)$.
26. The function $f(x)$ is periodic with period T . Prove that the number $T_1 = nT$, where n is any integer, $n \neq 0$, is also a period of that function.
27. The functions $f_1(x)$ and $f_2(x)$ are defined on the entire number axis and are not periodic. Can the function $\varphi(x) = f_1(x)f_2(x)$ be periodic?
28. The function $f(x)$ is defined on the interval $(-a; a)$. Prove that (a) the function $\varphi_1(x) = f(x) + f(-x)$ is even; (b) the function $\varphi_2(x) = f(x) - f(-x)$ is odd.
29. Prove that every function $f(x)$ defined on the symmetric interval $(-a; a)$ can be represented as the sum of an even and an odd function.
30. Prove that an even function cannot be strictly monotonic.
31. Find the function which is defined on the entire number axis and is even and odd at the same time.
32. The functions $f_1(x)$ and $f_2(x)$ are defined on the symmetric interval $(-a; a)$. (a) Prove that if $f_1(x)$ and $f_2(x)$ are even functions then the functions $\varphi_1(x) = f_1(x) \pm f_2(x)$ and $\varphi_2(x) = f_1(x)f_2(x)$ are even;
 (b) prove that if $f_1(x)$ and $f_2(x)$ are odd functions then the function $\varphi_3(x) = f_1(x) + f_2(x)$ is odd and $\varphi_4(x) = f_1(x)f_2(x)$ is even;
 (c) suppose $f_1(x)$ is an odd function and $f_2(x)$ is an even function. Prove that $\varphi_5(x) = f_1(x)f_2(x)$ is an odd function.

33. Prove that the even function $f(x)$ does not have an inverse.
 34. Prove that the periodic function $f(x)$ does not have an inverse.

9.2. Limit of a Function. Continuity

Find the following limits:

1. $\lim_{x \rightarrow 1} \frac{x^2 - 1}{2x^2 - x - 1}$. 2. $\lim_{x \rightarrow 1} \frac{x^3 - 1}{x^3 - x^2 + x - 1}$.
3. $\lim_{x \rightarrow -3} \frac{x^4 - 6x^2 - 27}{x^3 + 3x^2 + x + 3}$.
4. $\lim_{x \rightarrow 1} \left[\left(\frac{4}{x^2 - x^{-1}} - \frac{1 - 3x + x^2}{1 - x^3} \right)^{-1} + 3 \frac{x^4 - 1}{x^3 - x^{-1}} \right]$.
5. $\lim_{x \rightarrow \infty} \left(\frac{3x}{5x - 1} \cdot \frac{2x^2 + 1}{x^2 + 2x - 1} \right)$.
6. $\lim_{x \rightarrow \infty} \left(\frac{x^3}{3x^2 - 4} - \frac{x^2}{3x + 2} \right)$.
7. $\lim_{x \rightarrow \pi/6} \frac{2 \sin^2 x + \sin x - 1}{2 \sin^2 x - 3 \sin x + 1}$.
8. $\lim_{x \rightarrow \pi/4} \frac{1 - \cot^3 x}{2 - \cot x - \cot^3 x}$.
9. $\lim_{x \rightarrow 1} \frac{x^2 - \sqrt{x}}{\sqrt{x} - 1}$. 10. $\lim_{x \rightarrow 2} \frac{x - \sqrt{3x - 2}}{x^2 - 4}$.
11. $\lim_{x \rightarrow 1} \frac{\sqrt{5 - x} - 2}{\sqrt{2 - x} - 1}$.
12. $\lim_{x \rightarrow a} \frac{\sqrt{x - b} - \sqrt{a - b}}{x^2 - a^2}$, $a \neq 0$, $a > b$.
13. $\lim_{x \rightarrow 1} \frac{\sqrt{x} - 1}{\sqrt[3]{x} - 1}$. 14. $\lim_{x \rightarrow 0} \frac{\sqrt{1 + x} - \sqrt{1 - x}}{\sqrt[3]{1 + x} - \sqrt[3]{1 - x}}$.
15. $\lim_{x \rightarrow a} \left\{ \left[\left(\frac{\sqrt{a} + \sqrt{x}}{\sqrt[4]{a} - \sqrt[4]{x}} \right)^{-1} - \frac{2\sqrt[4]{ax}}{x^{3/4} - a^{1/4}x^{1/2} + a^{1/2}x^{1/4} - a^{3/4}} \right]^{-1} - \sqrt{2^{\log_4 a}} \right\}^8$.
16. $\lim_{x \rightarrow 2} \frac{2^x + 2^{3-x} - 6}{\sqrt{2-x} - 2^{1-x}}$.
17. $\lim_{x \rightarrow \pi/3} \frac{\sin(x - \pi/3)}{1 - 2 \cos x}$.

18. $\lim_{x \rightarrow \pi/3} \frac{\tan^3 x - 3 \tan x}{\cos(x + \pi/6)}$. 19. $\lim_{x \rightarrow \pi/6} \frac{1 - 4 \sin^2 x}{\cos 3x}$.
20. $\lim_{x \rightarrow 0} \frac{\sin 2x}{5x}$. 21. $\lim_{x \rightarrow 0} \sin 8x \cot 3x$.
22. $\lim_{x \rightarrow 0} \frac{(x^2 + 3x - 1) \tan x}{x^2 + 2x}$. 23. $\lim_{x \rightarrow 1} \frac{x^3 + x^2 - 2}{\sin(x - 1)}$.
24. $\lim_{x \rightarrow 0} \frac{\cos x \sin x - \tan x}{x^2 \sin x}$. 25. $\lim_{x \rightarrow 0} \frac{1 - \cos 5x}{3x^2}$.
26. $\lim_{x \rightarrow \pi} \frac{1 - \cos 7(\pi - x)}{5(x - \pi)^n}$, $n = 1, 2$.
27. $\lim_{x \rightarrow 0} \frac{\sin(a + 2x) - 2 \sin(a + x) + \sin a}{x^2}$.
28. $\lim_{x \rightarrow 0} \frac{\sqrt{1 + \tan x} - \sqrt{1 + \sin x}}{x^3}$.
29. $\lim_{x \rightarrow 0} \frac{\sqrt[3]{1 + x^2} - \sqrt[4]{1 - 2x}}{x + x^2}$.
30. Find the points of discontinuity of the function
- (a) $f(x) = \frac{x}{x^2 - 9}$; (b) $f(x) = \begin{cases} x^2 - 1, & \text{if } x \neq 0, \\ -2, & \text{if } x = 0; \end{cases}$
- (c) $f(x) = 1 + 2^{1/x}$; (d) $f(x) = (\sin x)/x$; (e) $f(x) = x/\cos x$; (f) $f(x) = [x]$.
31. Given the function $f(x) = 5\sqrt{x-1} + 2\sqrt{1-x}$. Is this function continuous at the point $x = 1$?
32. At what value of A is the following function continuous at the point $x = 2$:

$$f(x) = \begin{cases} \frac{x^2 - 4}{x - 2}, & \text{if } x \neq 2, \\ A, & \text{if } x = 2? \end{cases}$$

9.3. The Derivative of a Function

- Can we assert that the function $\varphi(x) = f_1(x) + f_2(x)$ does not have a derivative at the point $x = x_0$ if (a) the function $f_1(x)$ possesses a derivative at the point x_0 and the function $f_2(x)$ does not possess a derivative at that point; (b) neither of the functions $f_1(x)$ and $f_2(x)$ has a derivative at the point x_0 ?
- Can we assert that the function $\varphi(x) = f_1(x) f_2(x)$ does not have a derivative at the point $x = x_0$ if (a)

- the function $f_1(x)$ possesses a derivative at the point x_0 and the function $f_2(x)$ does not possess a derivative at the point x_0 ; (b) neither of the functions $f_1(x)$ and $f_2(x)$ possesses a derivative at the point x_0 ?
3. Prove that the derivative of an even differentiable function is an odd function.
 4. Prove that the derivative of an odd differentiable function is an even function.
 5. Prove that the derivative of a differentiable periodic function is a periodic function with the same period.
 6. The differentiable function $f(x)$ is such that $f(0) = 0$. Prove that

$$\lim_{x \rightarrow 0} \frac{f(x)}{x} = f'(0).$$

7. The differentiable functions $f(x)$ and $g(x)$ are such that $f(0) = g(0) = 0$, with $g'(0) \neq 0$. Prove that

$$\lim_{x \rightarrow 0} \frac{f(x)}{g(x)} = \frac{f'(0)}{g'(0)}.$$

8. Can we assert that if the function $f(x)$ possesses a maximum at the point x_0 , then in a certain, sufficiently small, neighbourhood of that point, to the left of the point x_0 , the function $f(x)$ increases and to the right of that point it decreases?
9. Find all the values of a for which the function $f(x)$ does not possess critical points:

$$(a) f(x) = (a^2 - 3a + 2) \left(\cos^2 \frac{x}{4} - \sin^2 \frac{x}{4} \right) + (a - 1)x + \sin 1;$$

$$(b) f(x) = (a^2 - 6a + 8) \frac{\sin(\pi + x)}{\sin(x + \pi/2)} + (a^2 - 7a + 12)(x - 2\sqrt{2});$$

$$(c) f(x) = (4a - 3)(x + \ln 5) + 2(a - 7) \cot \frac{x}{2} \sin^2 \frac{x}{2}.$$

10. Find the critical points of the function

$$y = 2 \sin^2 \frac{x}{6} + \sin \frac{x}{3} - \frac{x}{3},$$

whose coordinates satisfy the inequality $x^2 - 10 < -19.5x$.

11. Find the critical points of the function

$$f(x) = 4x^3 - 6x^2 \cos 2a + 3x \sin 2a \sin 6a + \sqrt{\ln(2a - a^2)}.$$

- Does $f(x)$ decrease or increase at the point $x = 1/2$?
12. Does $f(x)$ decrease or increase at the point $x = \sin 8$ if $f(x) = -x^3/3 + x^2 \sin 1.5a - x \sin a \sin 2a - 5 \arcsin(a^2 - 8a + 17)$?
13. Find all the values of a for which the function

$$f(x) = \left(\frac{\sqrt{a+4}}{1-a} - 1 \right) x^5 - 3x + \ln 5$$

decreases for all $x \in \mathbb{R}$.

14. Does the parameter b possess any values for which the function $f(x) = \left(1 - \frac{\sqrt{21-4b-b^2}}{b+1} \right) x^3 + 5x + \sqrt{6}$ is increasing at every point of its domain of definition?
15. Find the difference between the greatest and the least value of the function $y = \cos x + \frac{1}{2} \cos 2x - \frac{1}{3} \cos 3x$.
16. On the graph of the function $y = \frac{3}{\sqrt{2}} x \ln x$, where $x \in [e^{-1.5}; +\infty)$, find the point $M(x, y)$ such that the segment of the tangent to the graph of the function at that point, intercepted between the point M and the y -axis, is the shortest.
17. At what point $M(x, y)$ of the graph of the function $y = e^{-|x|}$ should a tangent be drawn for the area of the triangle bounded by that tangent and the coordinate axes be the greatest?
18. Prove that the curve $y = x^4 + 3x^2 + 2x$ does not meet the straight line $y = 2x - 1$ and find the distance between their nearest points.
19. At what value of a does the equation $ax^2 = \ln x$ possess a single root?

9.4. Integral Calculus. Miscellaneous Problems

1. Given the continuous periodic function $f(x)$, $x \in \mathbb{R}$. Can we assert that the antiderivative of that function is a periodic function?

2. The function $f(x)$ is defined and continuous on the interval $[-a; a]$, with $f(x) = -f(-x)$ for any $x \in [-a; a]$. (a) Prove that every antiderivative $F(x)$ of the function $f(x)$ is an even function;

(b) prove that
$$\int_{-a}^a f(x) dx = 0,$$

(c) calculate the integral
$$\int_{-1}^1 x^6 (\arcsin x)^7 dx.$$

3. The even function $f(x)$, $f(x) \neq 0$, is defined and continuous on the interval $[-a; a]$. Which of its antiderivatives $F(x)$ is an odd function?
4. Under what condition does the value of the integral
$$\int_a^b f(x) dx$$
 coincide with the value of the area of the curvilinear trapezoid bounded by the curves $y = f(x)$, $x = a$, $x = b$, $y = 0$?
5. The functions $y = 1 + \cos x$ and $y = 1 + \cos(x - \alpha)$, where $0 < \alpha < \pi/2$, are given on the interval $[0; \pi]$. At what value of α is the figure bounded by the curves $y = 1 + \cos x$, $y = 1 + \cos(x - \alpha)$, $x = 0$, equivalent to the figure bounded by the curves $y = 1 + \cos(x - \alpha)$, $y = 1$, $x = \pi$?
6. At what values of the parameter $a > 0$ is the area of the figure bounded by the curves $x = a$, $y = 2^x$, $y = 4^x$ larger or equal to the area bounded by the curves $y = 2^x$, $y = 0$, $x = 0$, $x = a$?
7. Find the critical points of the function $f(x)$ if

(a)
$$f(x) = 1 + x + \int_1^x (\ln^2 t + 2 \ln t) dt.$$

(b)
$$f(x) = x - \ln x + \int_2^x \left(\frac{1}{z} - 2 - 2 \cos 4z \right) dz.$$

8. On the interval $[5\pi/4; 4\pi/3]$ find the least value of the function

$$F(x) = \int_{5\pi/4}^x (3 \sin t + 4 \cos t) dt.$$

9. On the interval $[5\pi/3; 7\pi/4]$ find the greatest value of the function

$$F(x) = \int_{5\pi/3}^x (6 \cos u - 2 \sin u) du.$$

10. For the function $f(x) = 1 + 3^x \ln 3$ find the antiderivative $F(x)$, which assumes the value 7 for $x = 2$. At what values of x does the curve $F(x)$ cut the abscissa axis?
11. Prove the identity $\cos 2x = \cos^2 x - \sin^2 x$ by term-wise differentiation of the identity $\sin 2x = 2 \sin x \cos x$.
12. At what positive values of a do the graphs of the functions $f(x) = a |x + 1|$ and $\varphi(x) = x + a^2 |x|$ meet at three distinct points?
13. The graph of the function $y = 1 - 3x^2$ intersects at two points a straight line passing at an angle φ to the x -axis. Calculate the abscissa of the midpoint of the segment connecting the orthogonal projections of the points of intersection onto the x -axis.
14. Find all the values of φ for which the sum of the squares of the roots of the equation $x^2 + (\sin \varphi - 1)x - \frac{1}{2} \cos^2 \varphi = 0$ is the greatest.
15. At what values of the parameter a belonging to the interval $[\pi; 11\pi/8]$ do the roots of the quadratic equation $x^2 + 2\sqrt{\sin 2a}x + \cos 2a = 0$ exist and are distinct?
16. At what values of the parameter a belonging to the interval $[7\pi/6; 7\pi/4]$ does the quadratic trinomial $(\cot a)x^2 + 2\sqrt{\tan a}x + \tan a$ assume only positive values?
17. Find all the values of the parameter α for which the quadratic function $(\sin \alpha)x^2 + (2 \cos \alpha)x + (\cos \alpha + \sin \alpha)/2$ is the square of a linear function.
18. Find the values of b for which the equation $2 \log_{1/25}(bx + 28) = -\log_5(12 - 4x - x^2)$ has only one solution.
19. At what values of a is any solution of the inequality

$$\frac{\log_3(x^2 - 3x + 7)}{\log_3(3x + 2)} < 1$$

also a solution of the inequality $x^2 + (5 - 2a)x \leq 10a$?

20. Are the inequalities $f(x) > g(x)$ and $f'(x) > g'(x)$ equivalent?

21. Solve the following systems of equations:

$$(a) \begin{cases} 2 \arctan x + y - e^z = 3, \\ 4 \arctan x - y - 2e^z = 0, \\ \arctan x + y + e^z = 3a + 1; \end{cases}$$

$$(b) \begin{cases} 2x + \ln y^2 - 2 \sin z = 0, \\ 3x - 2 \ln y^2 + 4 \sin z = 7, \\ x + \ln y^2 + \sin z = 3a + 2. \end{cases}$$

22. Depict on the coordinate plane xOy the set of points whose coordinates satisfy the equation

$$x^3 + (3y + 1)x^2 + (4y + y^2)x + 5y^2 - 5y^3 = 0.$$

23. Find the numbers A , B and C such that the function of the form $f(x) = Ax^2 + Bx + C$ satisfies the conditions

$$f'(1) = 8, f(2) + f''(2) = 33, \int_0^1 f(x) dx = \frac{7}{3}.$$

24. Find the numbers K , L and M such that the function of the form $f(x) = \frac{Kx^2 + L}{x - 1} + Mx$ satisfies the conditions

$$f(2) = 23, f'(0) = 4 \text{ and } \int_{-1}^0 (x - 1)f(x) dx = \frac{37}{6}.$$

25. Find the numbers P , Q and R such that the function of the form $f(x) = Pe^{2x} + Qe^x + Rx$ satisfies the conditions

$$f(0) = -1, f'(\ln 2) = 31, \int_0^{\ln 4} [f(x) - Rx] dx = 19.5.$$

26. Use graphical means to solve the system

$$\begin{cases} x + y \leq 2, \\ x + y \geq 1, \\ x \geq 0, \\ y \geq 0, \end{cases}$$

for which the sum $z = 2x + 3y$ assumes the greatest value.

27. Find the least value of the function $x^2 + 2xy + 3y^2 + 2x - 3y - 5$. At what values of x and y can this least value be attained?
28. Construct the graph of the function

$$f(x) = \lim_{n \rightarrow \infty} \frac{x^n - x^{-n}}{x^n + x^{-n}}, \quad x > 0, \quad n \in \mathbb{N}.$$

29. Find the sum of the roots of the equation $\cos 4x + 6 = 7 \cos 2x$ on the interval $[0; 314]$.
30. Find the sum $S_1(x) = 1 + x^2 + x^4 + \dots + x^{2n}$ and then the sum $S_2(x) = 2x + 4x^3 + \dots + 2n \cdot x^{2n-1}$.
31. A point $A(x_1, y_1)$ with the abscissa $x_1 = 1$ and a point $B(x_2, y_2)$ with the ordinate $y_2 = 11$ are given in the rectangular Cartesian system of coordinates Oxy on the portion of the curve $y = x^2 - 2x + 3$ lying in the first quadrant. Find the scalar product of the vectors \vec{OA} and \vec{OB} .
32. In the rectangular Cartesian system of coordinates Oxy a tangent is drawn to the curve $y = 8/x^2$ at the point $A(x_0, y_0)$, where $x_0 = 2$, and the tangent cuts the x -axis at a point B . Find the scalar product of the vectors \vec{AB} and \vec{OB} .
33. At what values of c do the vectors $\mathbf{p} = (c \log_2 x; -6; 3)$ and $\mathbf{q} = (\log_2 x; 2; 2c \log_2 x)$ make an obtuse angle for any $x \in (0; \infty)$?
34. Find all the values of α for which the vector $\mathbf{a} = (1; 3; \sin 2\alpha)$ makes an obtuse angle with the z -axis if it is known that the vectors $\mathbf{b} = \left(\tan \alpha; -1; 2 \sqrt{\sin \frac{\alpha}{2}} \right)$ and $\mathbf{c} = \left(\tan \alpha; \tan \alpha; -\frac{3}{\sqrt{\sin \frac{\alpha}{2}}} \right)$ are mutually orthogonal.
35. Tangents are drawn from the point $A(1, 6)$ to the circle $x^2 + y^2 + 2x - 19 = 0$. Derive the equations of those tangents.

ANSWERS, HINTS, SOLUTIONS

Chapter 1

RATIONAL EQUATIONS, INEQUALITIES AND FUNCTIONS IN ONE VARIABLE

1.1. Linear Equations and Inequalities in One Variable. A Linear Function

1. $\{1\}$. 2. $\{-7\}$. 3. (a) $\{c \mid c \in \mathbb{R}\}$; (b) \emptyset . 4. $\{a\}$ for $a \neq 0$; $\{c \mid c \in \mathbb{R}\}$ for $a = 0$. 5. $\{a + 2\}$ for $a \neq 2$; $\{c \mid c \in \mathbb{R}\}$ for $a = 2$.

6. $\left\{ \frac{a^2 - 3a + 9}{a - 3} \right\}$ for $a \in (-\infty; -3) \cup (-3; 3) \cup (3; \infty)$;

$\{c \mid c \in \mathbb{R}\}$ for $a = -3$; \emptyset for $a = 3$. 7. (a) $(3/7; \infty)$; (b) $(-\infty; -5/4)$; (c) $(-\infty; -7)$; (d) $[3 + 2\sqrt{3}; \infty)$. 8. (a) $[1/a; \infty)$ for $a \in (-\infty; 0)$, $(-\infty; \infty)$ for $a = 0$, $(-\infty; 1/a]$ for $a \in (0; \infty)$; (b) $(-\infty; 1/a]$ for $a \in (-\infty; 0)$, \emptyset for $a = 0$, $(1/a; \infty)$ for $a \in (0; \infty]$; 9. (a) $(1/3; \infty)$; (b) $(-\infty; \pi/2)$; (c) $(-1; 2]$; (d) \emptyset . 10. $\{1; 2; 3; 4\}$. 11. (a) $\{-2; 4\}$.

▲ By the definition

$$|x-1| = \begin{cases} x-1, & \text{if } x-1 \geq 0, \\ -(x-1), & \text{if } x-1 < 0. \end{cases}$$

Therefore, the equation has two solutions: $x - 1 = 3$, $x_1 = 4$ and $-(x - 1) = 3$, $x_2 = -2$; (b) \emptyset .

12. (a) $\{3 - a; 3 + a\}$ for $a \in [0; \infty)$, \emptyset for $a \in (-\infty; 0)$;

(b) $\{a - 2; a + 2\}$ for $a \in (-\infty; \infty)$. 13. (a) $[3; \infty)$; (b) $(-\infty; 3]$;

(c) $\{1.5\}$. 14. $\left\{ -\frac{2}{3}; 4 \right\}$. ▲ The original equation is equivalent to

the equation $|2x - 1|^2 = |x + 3|^2$ or $(2x - 1)^2 - (x + 3)^2 = (2x - 1 + x + 3)(2x - 1 - x - 3) = 0$. Solving it, we find the roots. 15. $(-\infty; \infty)$ for $a = 4$; $\{a/2 + 2\}$ for $a \neq 4$. 16. (a) $\{-4.5; 4.5\}$. ▲ 1st method. We seek the solution of the equation on three intervals: (1) $-\infty < x < -4$, (2) $-4 \leq x < 4$, (3) $4 \leq x < \infty$. On the first interval the equation has the form $-(x - 4) + (-1)(x + 4) = 9$, whence we find that $2x = -9$, $x = -4.5$ is a root of the equation. On the second interval the equation has the form $-(x - 4) + (x + 4) = 9$, whence we get $8 = 9$ (a false equality) and, therefore, on the second interval the equation has no roots. For the third interval we have $(x - 4) + (x + 4) = 9$ or $2x = 9$; $x = 4.5$, the second root of the equation.

2nd method. The function $f(x) = |x - 4| + |x + 4|$ is even. Suppose $x_0 \geq 0$ is a root of the equation. Then $-x_0$ is also a root of the equation. Solving now the equation $-(x - 4) + (x + 4) = 9$ on the

interval $0 \leq x < 4$ and the equation $(x - 4) + (x + 4) = 9$ on the interval $4 \leq x < \infty$, we find the root $x = 4.5$. Since the function $f(x)$ is even, the second root of the equation is $x = -4.5$; (b) $[-4; 4]$; (c) $(-\infty; -4]$; (d) $[4; \infty]$. 17. $\{-6; 2\}$. 18. $\{0\}$. 19. (a) $(-\infty; \infty)$ for $a \in (-\infty; 0)$, $(-\infty; -a) \cup (a; \infty)$ for $a \in [0; \infty)$. \blacktriangle For $a \in (-\infty; 0)$ the inequality holds for any real x since $|x| \geq 0$ (by the definition of the absolute value of a number). For nonnegative values of a the original inequality is equal to the collection of the inequalities

$$\begin{cases} -x > a, & \text{if } x < 0; \\ x > a, & \text{if } x \geq 0; \end{cases}$$

if we unite the solutions of the collection obtained, we get a complete solution of the inequality; (b) $(-\infty; \infty)$; (c) $(-\infty; 0) \cup (2; \infty)$. 20. (a) \emptyset for $a \in (-\infty; 0]$. $(-a; a)$ for $a \in (0; \infty)$. \blacktriangle For positive values of a the original inequality is equivalent to the system of inequalities

$$\begin{cases} -x < a, \\ x < a, \end{cases}$$

or to the inequality $-a < x < a$; (b) \emptyset ; (c) $(-4; 0)$.

21. (a) $(-\infty; \infty)$; (b) $[1.5; \infty)$. 22. $[-0.75; 2.5]$. 23. $(-\infty; -2) \cup (3; \infty)$. 24. $(2; \infty)$. 25. $(-\infty; -3) \cup (-1; 0]$. 26. (a) $\{2\}$; (b) $\{4, 3\}$. 27. $\{-3\}$. 28. (a) $(1; \infty)$; (b) $(-\infty; 1)$. 29. $(-\infty; -2) \cup (-2; 2) \cup (2; \infty)$; $(1/(m^2 - 4))(x - |m|)$. 30. \bullet Consider the function $F(x) = k(kx + b) + b$.

31.

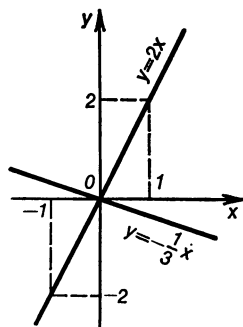

32.

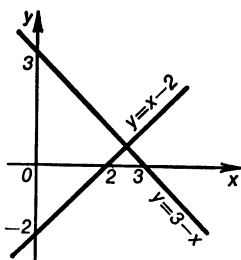

33.

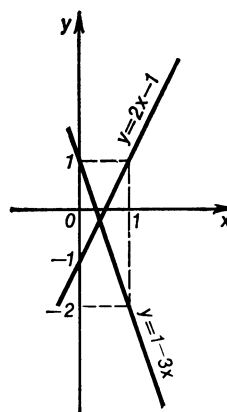

34.

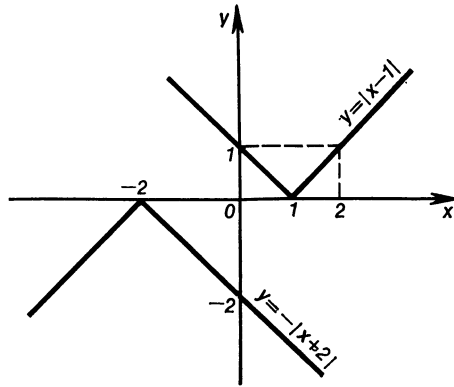

35.

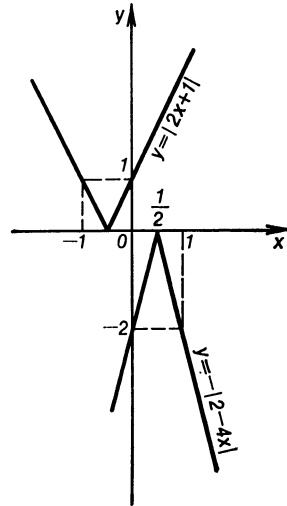

36.

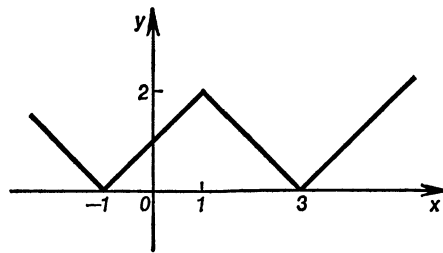

37.

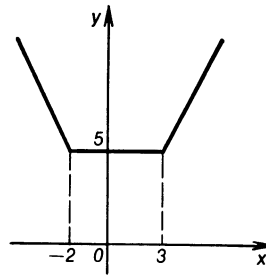

38.

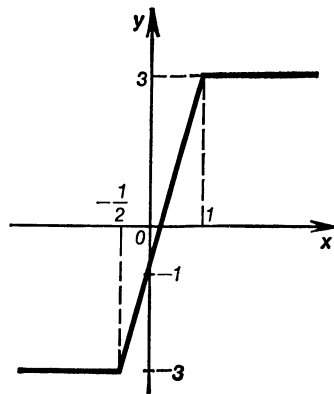

39.

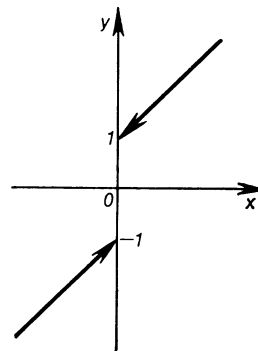

40.

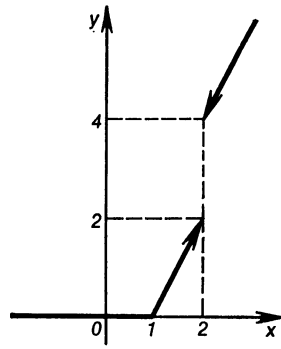

41.

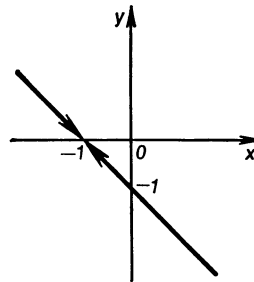

42.

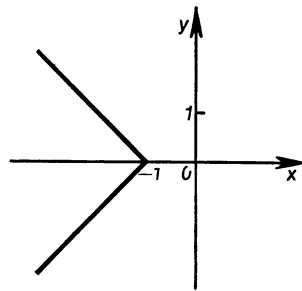

43.

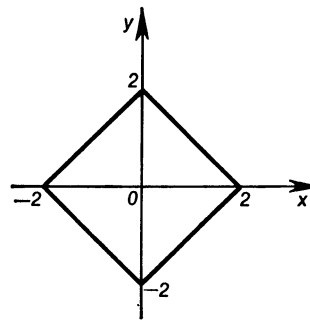

44.

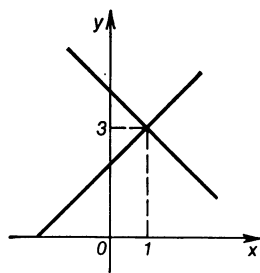

45.

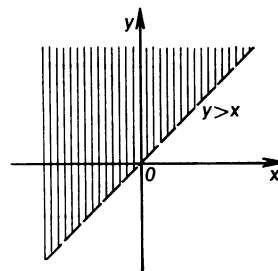

46.

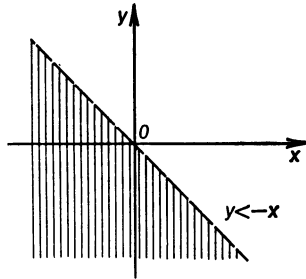

47.

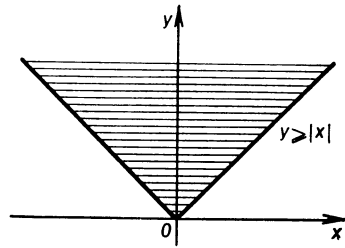

48.

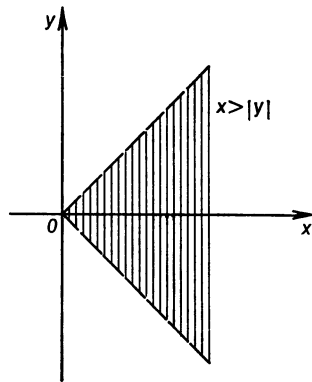

49.

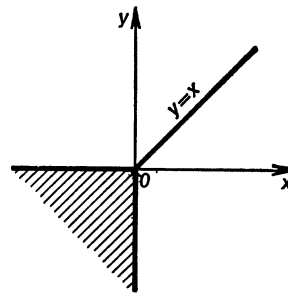

50.

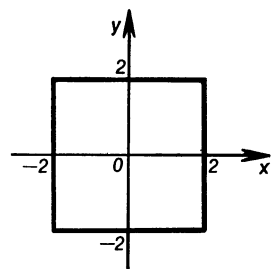

51.

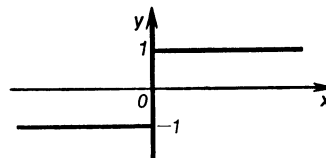

52.

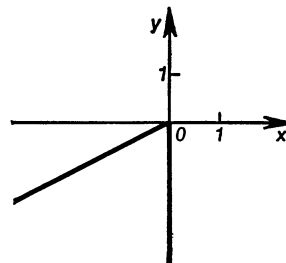

53. ▲ Since the given function is defined in the neighbourhood of the point $x = 0$ and $y(0) = 1$ at that point itself, it follows that for this function to be continuous at that point, it is necessary that $\lim_{x \rightarrow 0} (2x + 1) = \lim_{x \rightarrow 0} (-x + a) = 1$, i.e. $a = 1$. 54. (a) $\{-1/3\}$.

▲ The interior points of the domain of definition of the function at which the derivative is equal to zero or does not exist are called *critical points of the function*. The given function is differentiable at every point of its domain of definition (since it is defined throughout the number axis, all its points are interior), except for the point $x = 1/3$ and, therefore, $x = 1/3$ is a critical point and the equation $y' = 0$ has no solutions; (b) $(-\infty; -1]$. ▲ Let us represent the given function in the form

$$y = \begin{cases} 2x + 2, & \text{if } x \geq -1, \\ 0, & \text{if } x < -1. \end{cases}$$

On the interval $(-1; \infty)$ the derivative $y' = 2$, at the point $x = -1$ the derivative does not exist, and at all points of the interval $(-\infty; -1)$ the derivative $y' = 0$. Therefore, all the points of the ray $(-\infty; -1]$ are critical; (c) $[-1; 1]$; (d) $(-\infty; -3] \cup [3; \infty)$. 55. (a) Decreases on $(-\infty; \infty)$; (b) increases on $(-\infty; +\infty)$. 56. (a) Decreases on $(-\infty; 4)$, increases on $(4; \infty)$; (b) increases on $(-\infty; 0)$; decreases on $(0; \infty)$. 57. (a) Increases on $[-\infty; -10]$, decreases on $(10; \infty)$; (b) decreases on $(-5; 4)$; (c) decreases on the intervals $(-\infty; -4)$, $(-3; -2)$ and $(-1; 0)$; increases on the intervals $(-4; -3)$, $(-2; -1)$ and $(0; \infty)$. 58. (a) $x = 1/2$ is a point of minimum; (b) $x = 3/4$ is a point of maximum. 59. (a) $x = -2/3$ is a point of minimum; (b) $x = 2$ is a point of maximum. ● Use the theorem on the sufficient condition for the extremum of a function. 60. $x = -2$ is a point of maximum. 61. $x = 2$ is a point of minimum for $a = 2$. For other values of a the function has no points of extremum. ▲ Suppose $a < 2$ (for $a > 2$ the solution is similar). Then all the points of the interval $[a; 2]$ are critical but the condition for an extremum is not fulfilled at any of them. In the case $a = 2$ the function $y = 2|x - 2|$ has a minimum at the point $x = 2$ (at that point itself the function is nondifferentiable, but in the neighbourhood of that point the function is differentiable; in the left-hand neighbourhood the derivative is negative and in the right-hand neighbourhood it is positive). 62. $a \in [3; \infty)$. 63. $y_{\min}(1) = 1 - a$, $y_{\max}(2) = 2 - a$ for $a \in (-\infty; 1)$; $y_{\min}(2) = a - 2$; $y_{\max}(1) = a - 1$ for $a \in (2; \infty)$; $y_{\min}(a) = 0$, $y_{\max}(2) = 2 - a$, $a \in (1; 1.5)$; $y_{\min}(a) = 0$, $y_{\max}(1) = a - 1$ for $a \in (1.5; 2)$; $y_{\min}(1.5) = 0$; $y_{\max}(1) = y_{\max}(2) = 0.5$ for $a = 1.5$.

1.2. Quadratic Equations and Inequalities.

A Quadratic Function

1. (a) $\{3, 4\}$; (b) $\{-1; 5\}$; (c) $\{1/3; 1/2\}$; (d) $\{-1/3; -3\}$; (e) $\{1 \pm \sqrt{6}\}$;

(f) $\left\{ \frac{-1 \pm \sqrt{65}}{4} \right\}$. 2. (a) $(-\infty; -1) \cup (4; \infty)$;

(b) $[-1; 4]$; (c) $(-\infty; -2) \cup (-2; \infty)$; (d) $\{-1; 2\}$; (e) $(-\infty; \infty)$;

(f) \emptyset . 3. (a) $\{1/2\}$; (b) $\{-1; 3\}$; (c) $(-\infty; -3] \cup [3; 4)$;

(d) $[-5; 1] \cup \{5\}$; (e) \emptyset ; (g) $\{2\} \cup \left[2 \frac{161}{163}, 3\right]$.

4. (a) 5. ● Use the identity $x_1^2 + x_2^2 = (x_1 + x_2)^2 - 2(x_1x_2)$; (b) -22. ● Use the identity $x_1^3 + x_2^3 = (x_1 + x_2)^3 - 3(x_1x_2) \times (x_1 + x_2)$; (c) 127. 6. $\{1\}$. 9. $a \in (0; 4)$. ● Solve the inequality $(a^2 - 4a)/2 < 0$ ($(a^2 - 4a)/2 = x_1x_2$, where x_1 and x_2 are roots of the equation). 10. $a \in (-2; 2)$. 11. $k \in (-\infty; -1]$. ▲ The quadratic equation has real roots if $D = [2(k-1)]^2 - 4(k+5) \geq 0$. The solution of this inequality is (the union of the rays) $(-\infty; -1] \cup [4; \infty)$. For these values of k the roots can be both positive, of different signs and both negative. Let us find the values of k for which both roots are negative. By the Vieta theorem, we have a system of inequalities $x_1 + x_2 = -2(k-1) < 0$, $x_1x_2 = k+5 > 0$; its solution is the ray $[4; \infty)$. Thus, for all $k \in (-\infty; -1)$, at least one root of the equation is positive. 12. (a) $\left[-\sqrt{\frac{40}{7}}; -\frac{1+\sqrt{13}}{2}\right) \cup \left(\frac{\sqrt{13}-1}{2}; \sqrt{\frac{40}{7}}\right]$. ▲ Both roots x_1 and x_2 of the function

$f(x) = ax^2 + bx + c$, $a > 0$ are smaller than a certain number x_0 if the following conditions are simultaneously fulfilled:

$$\begin{cases} D = b^2 - 4ac \geq 0, \\ -b/2a = \frac{x_1 + x_2}{2} < x_0, \end{cases} \text{ or } \begin{cases} m^2 - 2 \cdot 4(m^2 - 5) \geq 0, \\ -m/4 < 1, \\ 2 \cdot 1^2 + m \cdot 1 + m^2 - 5 > 0. \end{cases}$$

Solving the system of inequalities, we get the answer;

(b) $\left[-\sqrt{\frac{40}{7}}; \frac{-\sqrt{13}+1}{2}\right) \cup \left(\frac{1+\sqrt{13}}{2}; \sqrt{\frac{40}{7}}\right]$.

13. $(-2; 3)$. 14. $(6; 6.75)$. ▲ The function $f(x) = ax^2 + bx + c$, $a > 0$, has roots x_1 and x_2 , confined between the numbers p and q , if and only if the following conditions are fulfilled:

$$\begin{cases} D = b^2 - 4ac > 0, \\ f(p) > 0, f(q) > 0, \\ p < -\frac{b}{2a} < q \end{cases} \text{ or } \begin{cases} [2(k-3)]^2 - 4 \cdot 9 > 0, \\ (-6)^2 + 2(k-3)(-6) + 9 > 0, \\ 1^2 + 2(k-3) \cdot 1 + 9 > 0, \\ -6 < -(k-3) < 1. \end{cases}$$

Solving this system, we get the answer. 15. $(5; 24)$. 16. $[0; 4/61)$. 17. $(2.5; \infty)$. 18. (a) $\{-2; 2\}$. ▲ The original equation is equivalent to the collection of the systems

$$\begin{cases} x^2 - x - 2 = 0, \\ x \geq 0; \end{cases} \quad \begin{cases} x^2 + x - 2 = 0, \\ x < 0. \end{cases}$$

The solutions of the equation of the first system are $x_1 = -1$ and $x_2 = 2$. The value of x_1 does not satisfy the inequality of this system

and, therefore, we have here only one solution $x = 2$. Similarly, we find the solution $x = -2$ of the second system; (b) \emptyset .

19. (a) $\{(-5 \pm \sqrt{41})/4; 1/2; 2\}$; (b) $\{(-1 \pm \sqrt{5})/2\}$.
 20. (a) $(-\infty; -3] \cup [2; \infty)$; (b) $[1/3; 1/2]$; (c) $(-\infty; -1] \cup [0; \infty)$;
 (d) \emptyset . 21. (a) $\{(1 \pm \sqrt{17})/2\}$; (b) $\{(1 \pm \sqrt{17})/2\}$. 22. (a) \emptyset ;
 (b) $\{(1 \pm \sqrt{13})/3\}$. 23. $\{-2/5; 2\}$. 24. (a) $(-4; 4)$. \blacktriangle The original inequality is equivalent to the collection of the systems of inequalities

$$\begin{cases} x^2 - x - 12 < 0, \\ x \geq 0; \end{cases} \quad \begin{cases} x^2 + x - 12 < 0, \\ x < 0. \end{cases}$$

The solutions of the first system are $x \in [0, 4)$, and of the second system, $x \in (-4; 0)$. Uniting these solutions, we get the answer;

- (b) $(-\infty; -3] \cup [3; \infty)$; (c) $[-5; -2] \cup [2; 5]$; (d) $(-\infty; \infty)$;
 (e) \emptyset . 25. (a) $(-\infty; -(5 + \sqrt{34})/3) \cup (\sqrt{34} - 5)/3, 1/3) \cup (3; \infty)$;
 (f) $[-2; 1]$. 26. (a) $(-\infty; -5] \cup [4; \infty)$; (b) $(0; 1/2)$; (c) $[-4; -2]$
 27. (a) $(-\infty; 1) \cup 2 + \sqrt{11}; \infty)$; (b) $(-3, 0) \cup (1, 2)$.
 28. (a) $(-\infty; -4) \cup (-3; (9 - \sqrt{465})/6) \cup (9 + \sqrt{465})/6; \infty)$;
 (b) $[-5/3; 5/3]$. 29. (a) $\{0\}$; (b) $[-1; 1]$; (c) $(-\infty; 1] \cup [3; \infty)$;
 (d) $(-\infty; -4) \cup (0; \infty)$; (e) $[-4; -1] \cup [0; 4]$; (f) $(-3; -1] \cup \{0\} \cup [1; 3)$. 31. $[5; \infty)$. 32. (a) $3 - \sqrt{8 + x}$; (b) $3 + \sqrt{8 + x}$.

33. (a); (b)

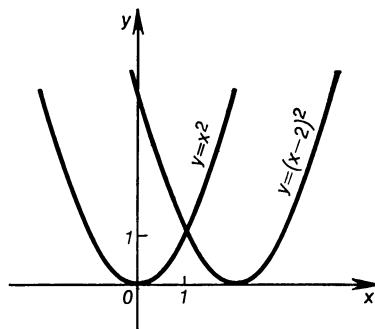

33. (c); (d)

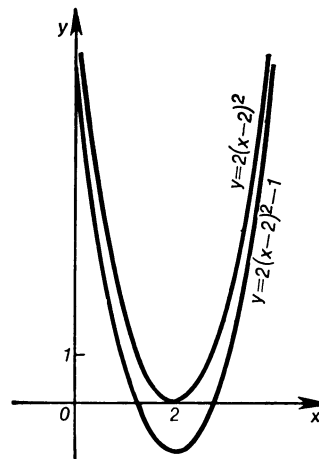

34. (a); (b)

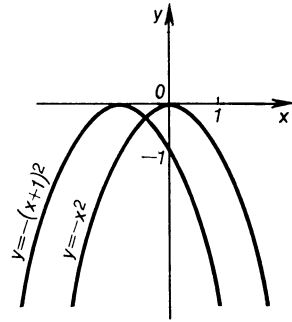

34. (c); (d)

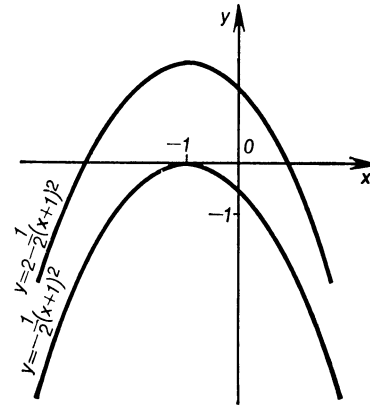

35.

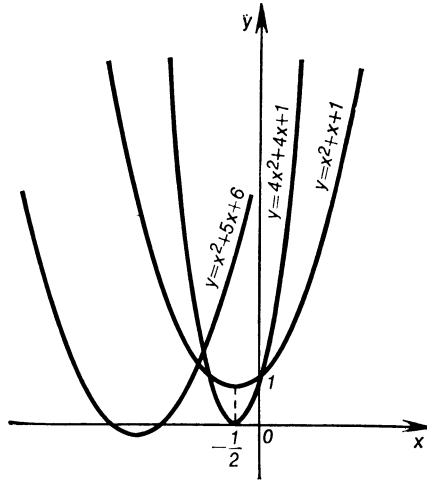

36.

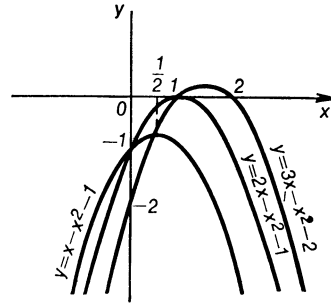

37. (a); (b)

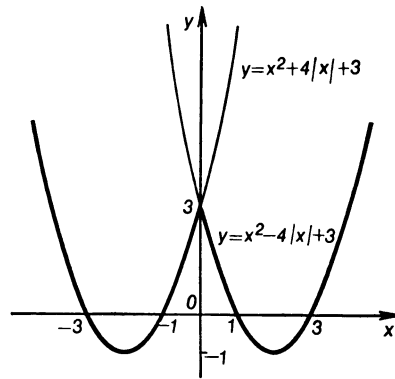

37. (c)

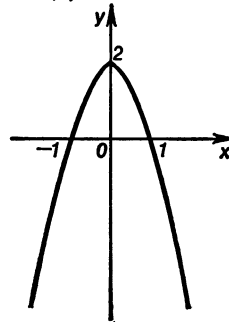

38.

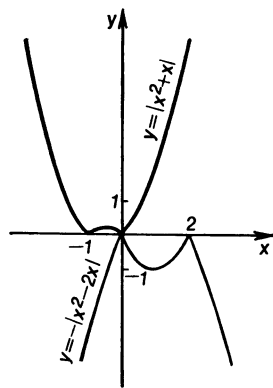

39. (a)

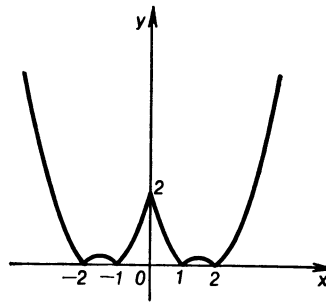

39. (b)

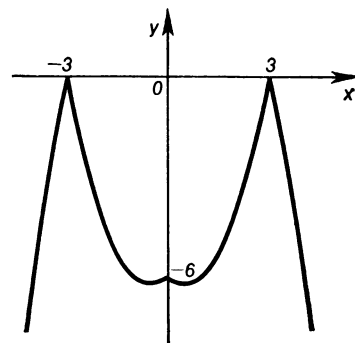

40.

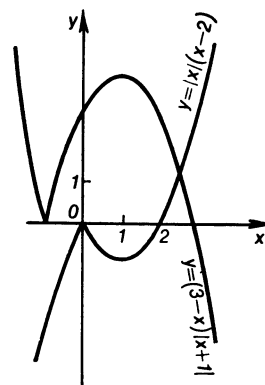

41.

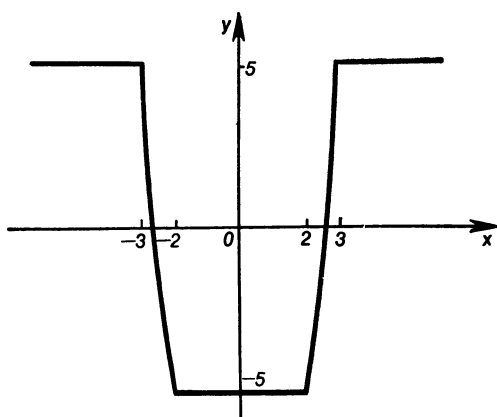

42. (a) $2x - 6$; (b) $-2x - 1$; (c) $6x + 1$; (d) $-8x - \tan 2$;
 (e) $x - \sqrt{3}$; (f) $-2x/3 + \pi$; (g) $10(5x + 1)$; (h) $4 - x/2$; (i) $2ax$;
 (j) $2(a - 1)x - a$. 43. (a) -3 ; (b) 7 ; (c) 0 ; (d) 1 . 44. (a) $\arctan 9$;
 (b) $\pi - \arctan 4$; (c) $\pi/3$; (d) $3\pi/4$; (e) $\pi - \arctan 13$. 45. (a) $y = 1 - 6x$;
 (b) $y = -3x + 3.5$; (c) $y = 4$. 46. 0.5 . 47. $(2a; 4a^2)$.
 ▲ The ordinates of the points of the parabola with the abscissas x_1 and x_2 are $y_1 = a^2$ and $y_2 = 9a^2$. The equation of the straight line passing through two points $M_1(x_1, y_1)$ and $M_2(x_2, y_2)$ is $\frac{x - a}{3a - a} = \frac{y - a^2}{9a^2 - a^2}$, or $y = 4ax - 3a^2$. Thus, the straight line has the slope $k = 4a$. Differentiating the function $y = x^2$ and setting $y'(x_0) = 2x_0 = k = 4a$, we obtain $x_0 = 2a$, $y_0 = (2a)^2 = 4a^2$. 48. $y = 1$.
 49. $y = -8$. 50. (a) 17 ; (b) $(-\infty; 17)$. 51. (a) $\{3\}$; (b) $\{2\}$; (c) $\{-5\}$;
 (d) $\{5\}$. 52. (a) $\{-1/2; 0; 1/2\}$; (b) $\{-3; 1/4\}$. 53. (a) $\{1; 3; 5\}$;
 (b) $\{-4; -2; 0\}$; (c) $\{-1\}$. 54. (a) $\{-3; -2; 1/2; 2\}$; (b) $[-\sqrt{3}; -1] \cup \{0\} \cup [1; \sqrt{3}]$. 55. (a) $\{1; 2\}$; (b) $\{1; 3\}$; (c) $\{2\}$. 56. (a) $(-\infty; 1.5)$;
 (b) $(-2; \infty)$; (c) $(-\infty; -1)$ and $(0; 1)$; (d) $(-\infty; -2)$, $(-1; 0)$ and $(1; 2)$. 57. (a) $(-1.5; \infty)$; (b) $(-\infty; 2)$; (c) $(-\infty; -0.5)$;
 (d) $(-(1 + \sqrt{17})/2; -1/2)$ and $((\sqrt{17} - 1)/2; \infty)$. 58. (a) $x = 0$ is a point of minimum; (b) $x = 0$ is a point of maximum, (c) $x = 1$ is a point of minimum; (d) $x = -2$ is a point of maximum; (e) $x = -1$ is a point of minimum; (f) $x = 1/8$ is a point of maximum.
 59. (a) The function has no points of extremum; (b) $x = -1.5$ is a point of minimum; (c) $x = -1$ is a point of maximum; $x = 0.5$ is a point of minimum. ▲ We have $y = -(x - 2)(x + 1)$ for $x < -1$, and in this domain, $y' = 1 - 2x$, with $y' > 0$ for all $x \in (-\infty; -1)$; $y = (x - 2)(x + 1)$, $y' = 2x - 1$ for $x > -1$, and $y' < 0$ for

$x \in (-1; 1/2)$. At the point $x = -1$ the derivative of the function does not exist (the point $x = -1$ is critical), but in its neighbourhood the derivative of the function exists and changes sign from plus to minus in the passage through that point. Consequently, $x = -1$ is a point of maximum; $y'(1/2) = 0$ and $y' > 0$ for $x \in (\frac{1}{2}; \infty)$ and, therefore, $x = 1/2$ is a point of minimum. 60. (a) $x = -1.5$ and $x = 1.5$ are points of minimum; $x = 0$ is a point of maximum; (b) $x = 0$ is a point of minimum; (c) $x = -0.5$ is a point of minimum. 61. (a) $x = -4, x = -2, x = 2, x = 4$ are points of minimum; $x = -3, x = 0, x = 3$ are points of maximum; (b) $x = (-\sqrt{65} - 1)/2, x = 4$ are points of minimum; $x = -0.5$ is a point of maximum. 62. (a) The function has no points of extremum; (b) $x = 0$ is a point of maximum. 63. (a) $y_{\min} = y(1) = 7, y_{\max} = y(2) = 15$; (b) $y_{\max} = y(2) = -14, y_{\min} = y(3) = -29$; (c) $y_{\max} = y(-1) = 8, y_{\min} = y(1) = 4$; (d) $y_{\min} = y(0) = -1, y_{\max} = y(3) = 8$. 64. (a) $y_{\max} = y(-3) = 10, y_{\min} = y(-1) = 2$; (b) $y_{\min} = y(1) = -2, y_{\max} = y(4) = 2$; (c) $y_{\min} = y(0) = 0, y_{\max} = y(2) = 4$. 65. ● Prove that $x_1 < -b/(2a) < x_2$. 66. ● Consider the function $\varphi(x) = f(x) - A$, for which x_1 and x_2 are zeros and use the equality $\varphi'(x) = f'(x)$ and the hint given in the answer to problem 65 of this section. 67. $(x_1 + x_2)/2$.

1.3. Inverse Proportionality

1. (a) $\{1/5\}$; (b) \emptyset ; (c) $\{4/a - 2\}$ for $a \in (-\infty; 0) \cup (0; \infty)$; \emptyset for $a = 0$; (d) $\{1/a + 2; -1/a + 2\}$ for $a \in (0; \infty)$; \emptyset for $a \in (-\infty; 0]$.
 2. (a) $\{-2\}$; (b) \emptyset ; (c) $\{-1; 3\}$; (d) $\{(a + 3)/2\}$ for $a \in (-\infty; -1) \cup (-1; 3) \cup (3; \infty)$; \emptyset for $a \in \{-1; 3\}$. 3. (a) $(0; 1)$; (b) $(-\infty; 0) \cup [1; \infty)$; (c) $(-\infty; 1) \cup (2; \infty)$; (d) $[-3.5; -3)$; (e) $(1 + a; 1)$ for $a \in (-\infty; 0)$; \emptyset for $a \in \{0\}$, $(1; 1 + a)$ for $a \in (0; \infty)$; (f) $(-\infty, -1) \cup [-1 - a; \infty)$ for $a \in (-\infty; 0)$; $(-\infty, -1) \cup (-1; \infty)$ for $a \in \{0\}$, $(-\infty; -1 - a] \cup (-1; \infty)$ for $a \in (0; \infty)$. 4. (a) $(-\infty; -3) \cup (1; \infty)$; (b) $(-\frac{5}{2}; \frac{3}{2})$. 5. (a) $[1; 4) \cup (4; \infty)$. ● Factorize numerator of the fraction; (b) $(-\infty; -3) \cup (-3, -\frac{1}{3})$. 6. (a) $(-\infty; -4] \cup [0; \infty)$; (b) $(-\infty; -4) \cup (8/7; 2) \cup (2; \infty)$. ▲ Since the parts of the inequality are positive, it follows that for $x \neq 0.5$, and $x \neq 2$ it is equivalent to the inequality $\frac{|x - 2|}{2} < \frac{|2x - 1|}{3}$. Squaring the last inequality and transferring all the terms into the left-hand part, we get, after the transformations (use the formula for the difference of squares), the inequality $(7x - 8)(x + 4) > 0$, solving which, we find the answer; (c) $(-\infty; 11/4) \cup (7/2; \infty)$. ● Set $|x - 2|/|x - 3| = y, y \geq 0$; (d) $(-\infty; 2)$, $a \in (-\infty; 0) \cup (2/3; \infty)$; $(2, \infty)$ for $a \in (0; 2/3)$; \emptyset for $a \in \{2/3\}$.

7. (a); (b)

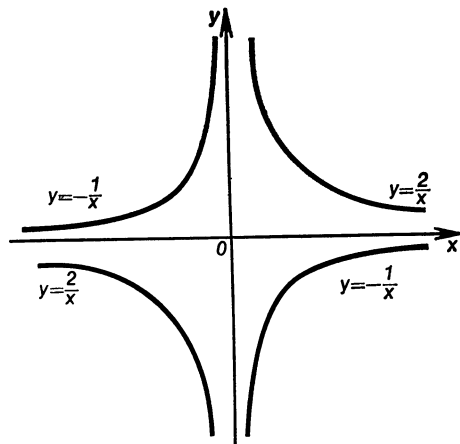

7. (c); (d)

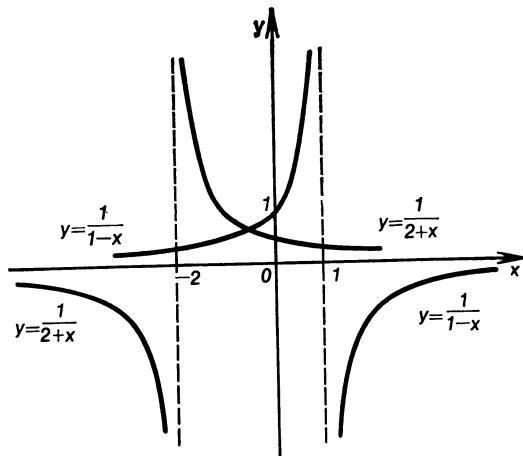

8. (a)

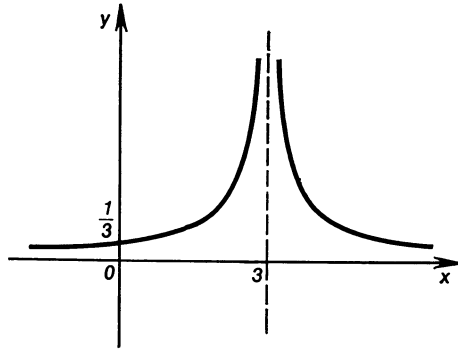

8. (b)

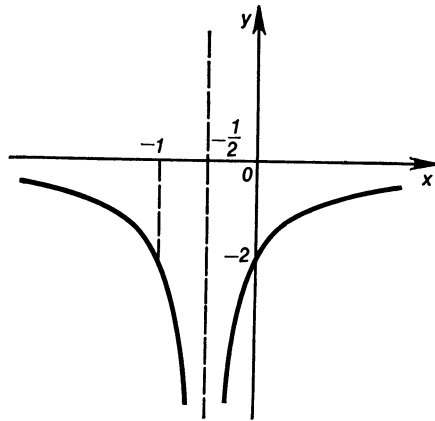

9. (a); (b)

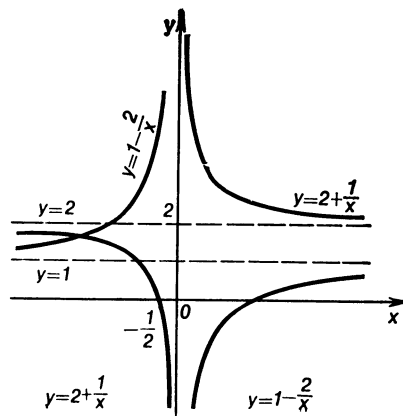

9. (c)

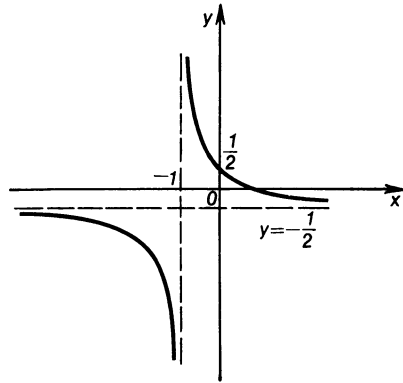

9. (d)

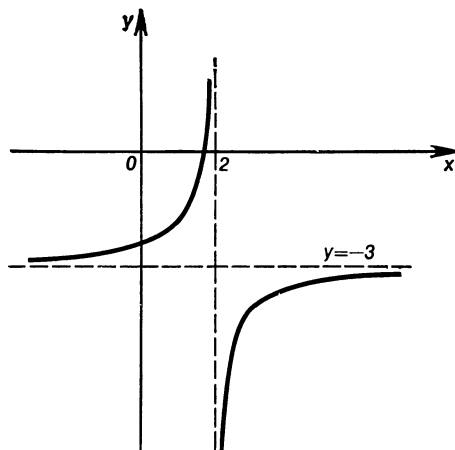

10. (a)

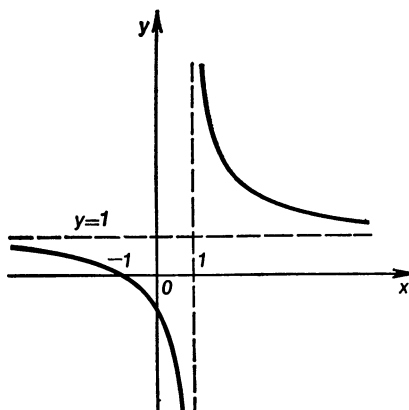

10. (b)

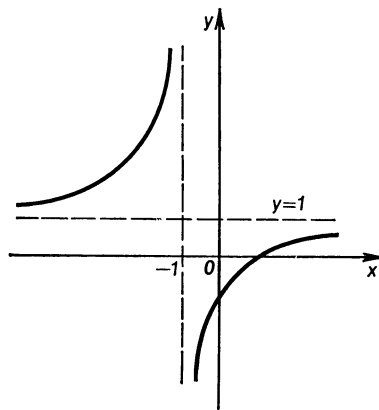

10. (c)

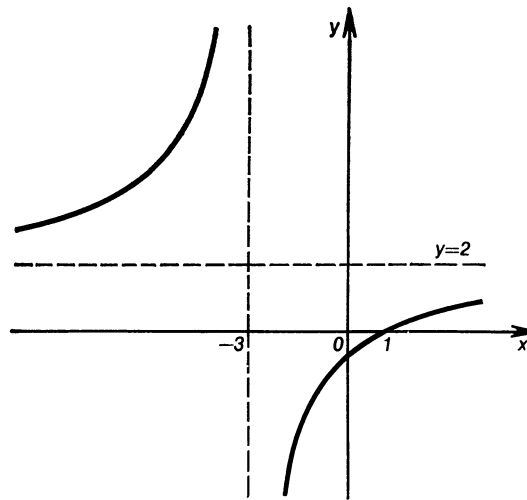

10. (d)

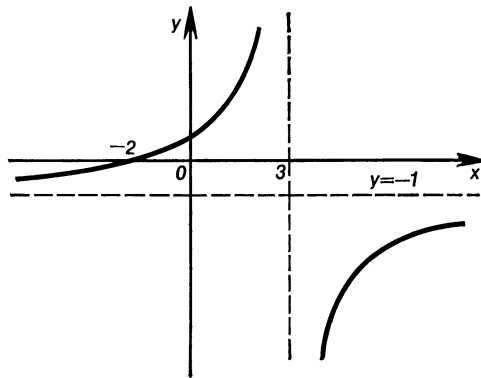

11. (a)

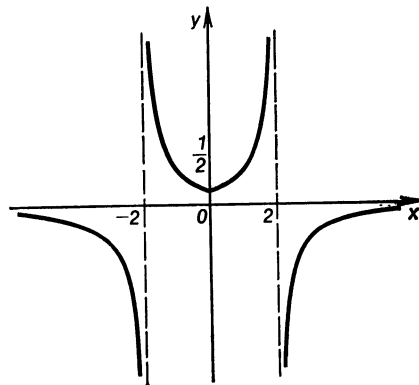

11. (b)

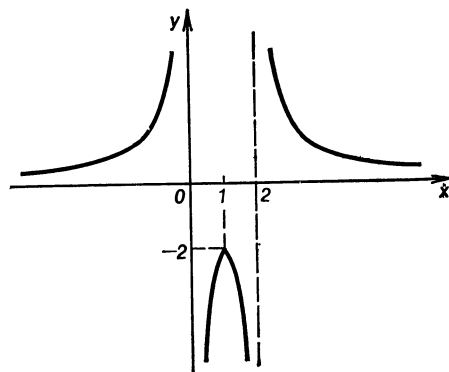

12. (a)

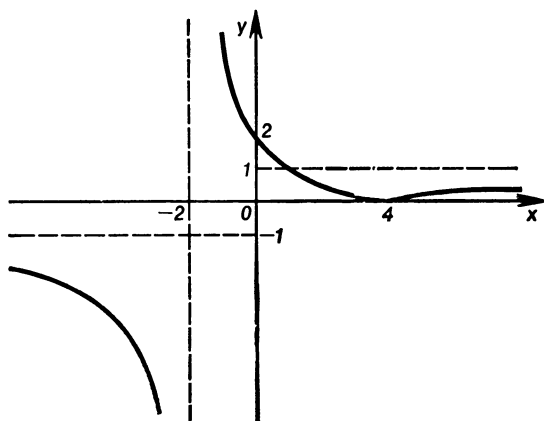

12. (b)

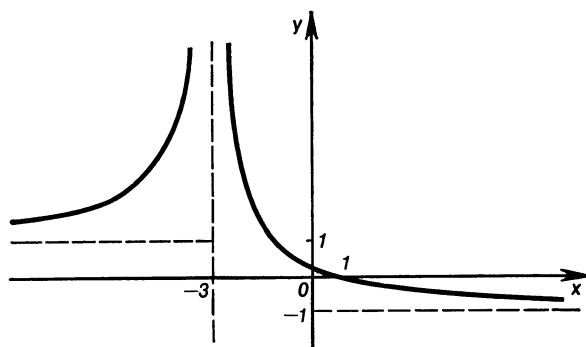

13. (a)

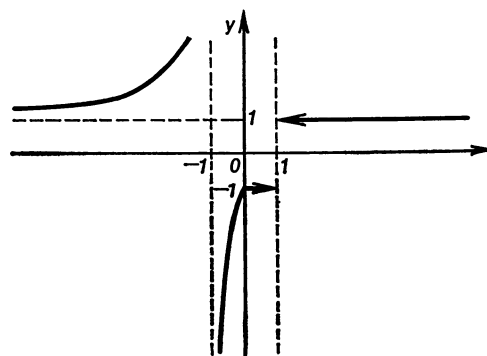

13. (b)

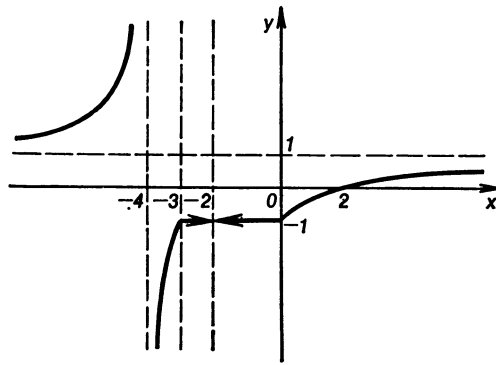

14. (a)

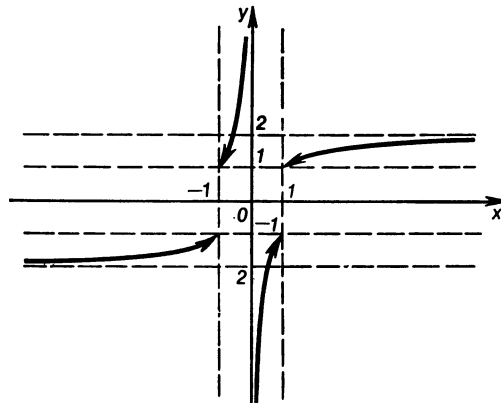

14. (b)

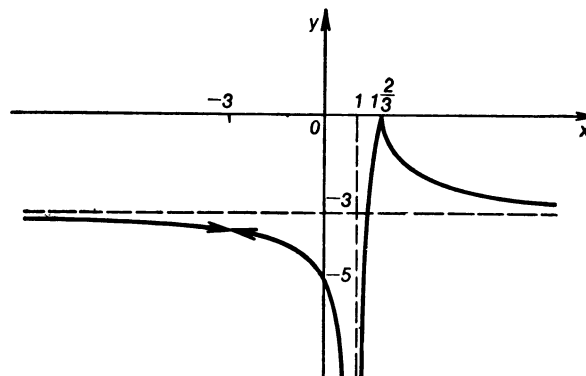

15. (a) $-\frac{1}{x^2}$; (b) $\frac{2}{x^2}$; (c) $-\frac{1}{2(x+1)^2}$; (d) $\frac{1}{(1-x)^2}$;
 (e) $\frac{2}{(x+2)^2}$; (f) $-\frac{2}{(2x-1)^2}$; (g) $\frac{5}{(x+1)^2}$; (h) $-\frac{11}{(1-3x)^2}$.
16. (a) -3 ; (b) $1/4$; (c) -1 ; (d) -1 . 17. (a) $\pi/4$; (b) $\arctan \frac{5}{9}$;
 (c) $\pi - \arctan \frac{1}{9}$; (d) $\pi - \arctan 4$; (e) $\pi - \arctan \frac{5}{4}$; (f) $\pi -$
 $-\arctan 6$. 18. (a) $x - 3y - 6 = 0$; (b) $y + x = 0$;
 (c) $4y - 5x + 6 = 0$; (d) $36y + 29x - 23 = 0$.
19. (a) $M_1(0; -1)$; $M_2(-2; 3)$; (b) $M_1(-1/2; -3)$; $M_2(-3/2; 5)$.
 ● Use the condition of perpendicularity of the straight lines $k_1 k_2 = -1$,
 where k_1 and k_2 are angular coefficients. 20. ● Show that $y'(0) =$
 $= y'(4)$. 21. $y + x = 0$, $x + 25y = 0$. ▲ The equation of the straight
 line passing through the origin has the form $y = kx$. Suppose
 $M(x_0; y_0)$ is a point of the hyperbola through which the tangent passes.
 Then, $kx_0 = (x_0 + 9)/(x_0 + 5)$ and $k = y'(x_0) = -4/(x_0 + 5)^2$.
 Eliminating k in these equations, we get $x_0^2 + 18x_0 + 45 = 0$, whence
 we find $x_{01} = -15$, $x_{02} = -3$ and, respectively, $k_1 = -1/25$ and
 $k_2 = -1$. 22. ● Investigate the sign of the derivative on the interval
 and show that $y'(x_0) \neq 0$ for any $x_0 \in (x_1; x_2)$. 23. (a) $y_{\min}(0) = -3$,
 $y_{\max}(2) = -1/3$; (b) $y_{\max}(-1) = 1/3$, $y_{\min}(1) = -3$.
 24. $x_0 = \sqrt{x_1 x_2}$ if $x_1 > 0$, and $x_0 = -\sqrt{x_1 x_2}$ if $x_2 < 0$.

1.4. Equations and Inequalities of Higher Degrees. A Rational Function

1. (a) $\{-3; -1; 1\}$; (b) $\{-3/2\}$; (c) $\{-3\}$; (d) $\{1/2\}$; (e) $\{1\}$; (f) $\{-2\}$;
 (g) $\{-1\}$; (h) $\{2\}$; (i) $\{-1\}$; (j) $\{1\}$. ● (a) – (k). Factorize the left-hand
 side of the equation. 2. ▲ Suppose $x_1 = p/q$, where $p \in \mathbb{Z}$, $q \in \mathbb{N}$, and
 p and q are coprime numbers. Then $\frac{p^3}{q^3} + a \frac{p^2}{q^2} + b \frac{p}{q} + c = 0$, or
 $p(p^2 + apq + bq^2) = -cq^3$. The right-hand side of the last equality
 is a multiple of q . The left-hand side is divisible by q if and only if
 $q \equiv 1$, because $p^2 + apq + bq^2$ is not divisible by q (two summands are
 multiples of q and the third, p^2 , is not). Consequently, the last equa-
 tion has the form $p(p^2 + ap + b) = -c$, and it follows that c is
 a multiple of $p = x_1$. 3. (a) $\{-2; -1; 1\}$. ▲ The constant term of the
 given equation is equal to -2 and, therefore, only the numbers ± 1 , ± 2
 can be rational roots. Substituting $x = 1$ into the equation, we get
 $1^3 + 2 \cdot 1^2 - 1 - 2 = 0$, i.e. 1 is a root of the equation. Factorizing
 now the left-hand side, we get $x^3 - 1^3 + 2x^2 - 2 \cdot 1^2 - x + 1 =$
 $= (x - 1)(x^2 + x + 1) + 2(x - 1)(x + 1) - (x - 1) =$
 $= (x - 1)(x^2 + 3x + 2) = 0$. Solving the equation $x^2 + 3x + 2 =$
 $= 0$, we find the other roots of the original equation, (b) $\{-3, 2\}$.
Remark. The given equation has two equal roots: $x = 2$. Such roots
 are called multiple roots. The root $x = 2$ is a root of multiplicity 2;

(c) {3}; (d) {1}; (e) $\{-1, -1/2, 1/3\}$. ● Set $x = -1/y$, (f) {1/2}. Multiply the equation by 4 and set $2x = y$. 4. ● Use the identity $a(x - x_1)(x - x_2)(x - x_3) \equiv ax^3 + bx^2 + cx + d$. 5. $-2p$.

6. $\{\sqrt[3]{(\sqrt{13} + 3)/2} - \sqrt[3]{(\sqrt{13} - 3)/2}\}$. ▲ Set $x = y - 1/y$. Then the equation assumes the form

$$y^3 - \frac{1}{y^3} - 3\left(y - \frac{1}{y}\right) + 3\left(y - \frac{1}{y}\right) - 3 = 0, \text{ or } y^3 - \frac{1}{y^3} - 3 = 0.$$

Putting now $y^3 = t$ we arrive at an equation $t^2 - 3t - 1 = 0$. This equation has roots $t_1 = (\sqrt{13} + 3)/2$, $t_2 = (3 - \sqrt{13})/2$, ($t_1 t_2 = -1$). Whence we get $y_1 = \sqrt[3]{t_1}$ and

$$\begin{aligned} x_1 &= \sqrt[3]{t_1} - \frac{1}{\sqrt[3]{t_1}} = \sqrt[3]{\frac{3 + \sqrt{13}}{2}} - 1 / \sqrt[3]{\frac{3 + \sqrt{13}}{2}} \\ &= \sqrt[3]{\frac{\sqrt{13} + 3}{2}} - \sqrt[3]{\frac{\sqrt{13} - 3}{2}}. \end{aligned}$$

Use your skill to verify that $x_2 = \sqrt[3]{t_2} - 1/\sqrt[3]{t_2} = x_1$.

7. (a) $\{-3; -2; 1; 3\}$; (b) $\{-5; -2; 1; 2\}$; (c) $\{(1 \pm \sqrt{13})/2\}$; (d) \emptyset ; (e) $\{-2; 1; 2; 4\}$. ● Factorize the left-hand side of the equation; (f) $\{-5; -2\}$. ● Decompose the polynomial $x^4 + 11x^2 + 10$ into two factors. 8. ● See the solution of problem 2 of this section.

9. (a) $\{-5; -1; 1; 3\}$; (b) $\{2; 6\}$; (c) $\{-1\}$; (d) the equation does not possess rational roots; (e) $\{-1/3; 1/2\}$. ● Set $x = -1/y$.

10. (a) $\{-\sqrt{2}, -1/\sqrt{2}; 1/\sqrt{2}, \sqrt{2}\}$. ● Set $x^2 = y$; (b) $\{-\sqrt{3}, \sqrt{3}\}$.

11. (a) $\{-1, 1\}$; (b) $\{2\}$. ▲ Setting $2x - 3 = y + c$ (1) and $2x - 5 = y - c$ (2), we get an equation $(y + c)^4 + (y - c)^4 = 2$. (3) The constant c can be found from equation (1) and (2): $c = 1$. After the transformations, equation (3) assumes the form $y^4 + 6y^2 = 0$. The latter has a unique root $y = 0$. Then we have $2x - 3 = 1$, $x = 2$.

Remark. By means of the substitution $ax + b_1 = y + c$, $ax + b_2 = y - c$, where $c = (b_1 - b_2)/2$, the equations of the form $(ax + b_1)^4 + (ax + b_2)^4 = k$ can be reduced to biquadratic equations.

12. (a) $\{-1 - \sqrt{7}; -1 - \sqrt{2}; -1 + \sqrt{2}; \sqrt{7} - 1\}$. ● Set $x^2 + 2x = y$, (b) $\{-1/2; 1\}$. 13. (a) $\{-a(1 + \sqrt{13})/2;$

$+a(\sqrt{13} - 1)/2 \mid a \in \mathbb{R}\}$. ● Set $x^2 + ax = y$;

(b) $\{(-5 - \sqrt{21})/6, (\sqrt{21} - 5)/6\}$. 14. (a) $\{-\sqrt{2}; 4 - \sqrt{18}; \sqrt{2}, \frac{4}{3} + \sqrt{18}\}$. ▲ We set $x - 2/x = y$ and then we have

$\left(x - \frac{2}{x}\right)^2 = x^2 + \frac{4}{x^2} - 4 = y^2$, whence it follows that $x^2 + \frac{4}{x^2} = y^2 + 4$. The original equation now assumes the form $y^2 - 8y = 0$.

The roots of this equation are $y_1 = 0$ and $y_2 = 8$. Then, solving the equations $x - 2/x = 0$ and $x - 2/x = 8$, which can be reduced to quadratic equations, we get the answer; (b) $\{-3/2, -(1 + \sqrt{7})/4; (\sqrt{7} - 1)/4; 1\}$. ● Divide the equation by x^2 and put $2x - 3/x = y$; (c) $\{1/2; 2\}$. ● Cancel the fraction on the left-hand side of the equation

by $x + 1$; (d) $\{-1; 9; (5 - \sqrt{61})/2; (5 + \sqrt{61})/2\}$. ● Divide the equation by x^2 and put $x - 9/x = y$. 15. (a) $\{(1 - \sqrt{21})/2; (1 + \sqrt{21})/2\}$. ▲ Subtracting $10x^2/(x + 5)$ from both parts of the equation, we get, after the transformation, $(x^2/(x + 5))^2 + 10x^2/(x + 5) - 11 = 0$. Assuming $x^2/(x + 5) = y$, we get $y^2 + 10y - 11 = 0$, whence we obtain $y_1 = 1, y_2 = -11$. Thus we have two equations $x^2/(x + 5) = 1$ and $x^2/(x + 5) = -11$, solving which we get the answer (the second equation does not have real roots); (b) $\{-1 - \sqrt{7}; \sqrt{7} - 1\}$. ● Reduce the equation to the form

$$\left(\frac{x^2}{x-3}\right)^2 - 6\frac{x^2}{x-3} - 16 = 0, \text{ and set } \frac{x^2}{x-3} = y.$$

16. (a) $\{-(1 + \sqrt{2\sqrt{2}-1})/\sqrt{2}; (\sqrt{2\sqrt{2}-1}-1)/\sqrt{2}\}$. ● Reduce the equation to the form $(x^2 + 1)^2 - 2(x - 1)^2 = 0$, (b) $\{-\sqrt{2}/(\sqrt{2\sqrt{2}-1}+1); \sqrt{2}/(\sqrt{2\sqrt{2}-1}-1)\}$. ● Set $x = 1/y$; (c) $\{-9; 11\}$. ● Add $4x^2 + 400x + 1$ to both parts of the equation. 17. (a) $\{-a, a - \sqrt{a^2 + 2}, a + \sqrt{a^2 + 2} \mid a \in \mathbb{R}\}$. ▲ Let us solve the given equation for a . We have

$$a = \frac{-(x^2 + 2) + (3x^2 - 2)}{4x} = \frac{x^2 - 2}{2x}, \quad (1)$$

or

$$a = \frac{-(x^2 + 2) - (3x^2 - 2)}{4x} = -x. \quad (2)$$

Solving now equations (1) and (2) for x , we get the answer.

(b) $\{-1 - \sqrt{3 + a}; -1 + \sqrt{3 + a}\}$ for $a \in [-3, -1]$, $\{-1 - \sqrt{3 + a}; \sqrt{3 + a} - 1; -1 - \sqrt{1 + a}; \sqrt{1 + a} - 1\}$ for $a \in [-1; \infty)$, \emptyset for $a \in (-\infty; -3)$. ▲ Let us solve the given equation for a assuming x to be the parameter: $a^2 - 2(x^2 - 1)a + x^4 - 6x^2 + 4x = 0$;

$$a = x^2 + 2x - 2 \quad (1) \quad \text{or} \quad a = x^2 - 2x \quad (2).$$

Solving equations (1) and (2) for x , we obtain $x_{1,2} = -1 \pm \sqrt{3 + a}$, $x_{3,4} = -1 \pm \sqrt{1 + a}$. The roots x_1 and x_2 are real if $a \in [-3; \infty)$, and x_3 and x_4 are real if $a \in [-1; \infty)$. 18. $\{(1 - \sqrt{29})/2; (5 - \sqrt{17})/2; (1 + \sqrt{29})/2; (5 + \sqrt{17})/2\}$. ▲ We represent the left-hand part of the equation as $(x^2 + ax + c)(x^2 + bx + d) = 0$, or $x^4 + (a + b)x^3 + (ab + c + d)x^2 + (bc + ad)x + cd = x^4 - 4x^3 - 10x^2 + 37x - 14$. We have a system

$$\begin{cases} a + b = -4, \\ ab + c + d = -10, \\ bc + ad = 37, \\ cd = -14. \end{cases}$$

Since a, b, c and d are integers, it follows from the last equation that either $c = -1, d = 14$ or $c = 2, d = -7$. The system is completely

satisfied by the second pair of values of c and d ; for these values we get $a = -5$ and $b = 1$ for the other coefficients. Solving now the equations $x^2 - 5x + 2 = 0$ and $x^2 - x - 7 = 0$, we find the roots of the original equation. 19. (a) $(-2, 1) \cup (3; \infty)$. \blacktriangle For $x \in (3; \infty)$, all the terms in the product are positive and, consequently, $p(x) = (x+2)(x-1)(x-3) > 0$ for all $x \in (3; \infty)$; for $x \in (1; 3)$ the term $x-3$ is negative (alone), and each of the terms $(x-1)$ and $(x+2)$ is positive. Therefore, $p(x) < 0$ for $x \in (1; 3)$, and for $x \in (-2; 1)$ the polynomial $p(x)$ has two negative terms $((x-3)$ and $(x-1)$) and one positive term $(x+2)$. This means that $p(x) > 0$ for $x \in (-2; 1)$; for $x \in (-\infty; -2)$ all the three terms are negative and, therefore, $p(x) < 0$ on this interval. Uniting the intervals, where $p(x) > 0$, we get the answer; (b) $(-2, 0) \cup (1; 2)$; (c) $[-4, -2] \cup \{1\}$; (d) $(-3; 2)$ for $n = 2k - 1, k \in \mathbb{N}$; $(-\infty; -3) \cup (-3; 2)$ for $n = 2k, k \in \mathbb{N}$. 20. (a) $(-3; 2) \cup (4; \infty)$; (b) $(-\infty, -2] \cup \{-1\}$; (c) $(1/2; \infty)$. 21. (a) $(-\infty; -1] \cup \{1\} \cup [2; \infty)$; (b) $(-5; -1)$. 22. (a) $(-\infty; -\sqrt{3}) \cup (-1/\sqrt{3}; 1/\sqrt{3}) \cup \sqrt{3}; \infty)$; (b) $(2 - 4/\sqrt{3}; 1) \cup (3; 2 + 4/\sqrt{3})$. \bullet Set $x - 2 = y$. 23. (a) $(-\infty; \infty)$. \bullet Set $x^2 - x = y$; (b) $(-3 + \sqrt{33})/2; (\sqrt{33} - 3)/2$. \bullet Set $x^2 + 3x + 1 = y$.

24. (a) $(1 + \sqrt{3} - \sqrt{3 + 2\sqrt{3}}; 1 + \sqrt{3} + \sqrt{3 + 2\sqrt{3}})$. \blacktriangle The original inequality is equivalent to the inequality $p(x) = x^4 - 4x^3 - 6x^2 - 4x + 1 < 0$. We factorize the polynomial on the left-hand side of the inequality, for which purpose we solve the equation $p(x) = 0$. Since $x = 0$ does not satisfy the given equation, it follows that it is equivalent to the equation $x^2 + 1/x^2 - 4(x + 1/x) - 6 = 0$. Setting now $x + 1/x = y$, we obtain an equation $y^2 - 4y - 8 = 0$, whose roots are $y_1 = 2(1 + \sqrt{3})$ and $y_2 = 2(1 - \sqrt{3})$. The polynomial $p(x)$ can now be represented as $(x^2 - 2(1 + \sqrt{3})x + 1)(x^2 - 2(1 - \sqrt{3})x + 1)$. Here $x^2 - 2(1 - \sqrt{3})x + 1 > 0$ for any $x \in \mathbb{R}$ and, therefore, the original inequality is equivalent to the inequality $x^2 - 2(1 + \sqrt{3})x + 1 > 0$ whose solutions are given in the answer; (b) $(-1 - \sqrt{3}, (3 - \sqrt{17})/2) \cup (\sqrt{3} - 1, (3 + \sqrt{17})/2)$. \bullet When you factorize the left-hand part of the inequality, make use of the substitution $y = x - 2/x$. 25. \blacktriangle We have

$$p(x) = (x-1)x[x^4(x^2+x+1)+1]+1 \quad (1)$$

or

$$p(x) = (1-x) + x^2(1-x^3) + x^8. \quad (2)$$

It follows from (1) that $p(x) > 0$ for $x \in (-\infty; 0] \cup [1; \infty)$, and from (2) that $p(x) > 0$ for $x \in (0; 1)$. Thus, $p(x) > 0$ for any $x \in \mathbb{R}$.

26. \blacktriangle The function $f(x) = \frac{P(x)}{Q(x)}$ is defined throughout the number axis, except for the points $x_k, k \in \mathbb{N}, k \leq n$, which are zeros of the polynomial $Q(x)$. Suppose x_0 is one of the solutions of the inequality $f(x) > 0$. Then $P(x_0)$ and $Q(x_0)$ are numbers of the same sign and, consequently $\varphi(x_0) = P(x_0)Q(x_0) > 0$, i.e. x_0 is also one of the solutions of the inequality $\varphi(x) = P(x)Q(x) > 0$. (For $x = x_k$ the value of the function $\varphi(x_k)$ is equal to zero and the values of x_k do not satisfy the inequality $\varphi(x) > 0$.) Thus, all solutions of the inequality

$f(x) > 0$ are also solutions of the inequality $\varphi(x) > 0$ (because of the arbitrariness of the choice of the number x_0). We can prove by analogy that if x_0 is some solution of the inequality $\varphi(x) > 0$, then this number x_0 is also a solution of the inequality $f(x) > 0$ ($P(x_0)$ and $Q(x_0)$ are numbers of the same sign). If $P(x)$ and $Q(x)$ assume values of different signs for all x from the domain of the function $f(x)$, then the inequalities $f(x) > 0$ and $\varphi(x) > 0$ have no solutions, i.e. these inequalities are also equivalent. 27. (a) $(-2; 0) \cup (2; \infty)$. \blacktriangle The inequality

$$\frac{2}{x-2} - \frac{1}{x} = \frac{x+2}{x(x-2)} > 0$$

is equivalent to the inequality $(x+2)(x-2)x > 0$; solving it by the method of intervals, we get the answer; (b) $(-1, 2)$; (c) $(-\infty; -1) \cup (0, 1/2] \cup (1, 2)$; (d) $(1; 5/3) \cup (2; 7/3) \cup (3; \infty)$. \bullet Reduce the left-hand part of the inequality to the form $x + 1/(x-1) + x + 1/(x-3)$; (e) $(-2; -1) \cup [0; 1] \cup [2; \infty)$; (f) $(-7; -\sqrt{37}) \cup (-5; 0) \cup (5; \sqrt{37}) \cup (7; \infty)$. 28. (a) $(-1; 0)$. \bullet Set $x^2 + x = y$; (b) $(-\infty; -2) \cup (-1; 1) \cup (2; 3) \cup (4; 6) \cup (7; \infty)$. \blacktriangle Let us transform the left-hand side of the inequality

$$\begin{aligned} & \left(\frac{1}{x-1} - \frac{1}{x-4} \right) + 4 \left(\frac{1}{x-3} - \frac{1}{x-2} \right) \\ &= \frac{4}{x^2-5x+6} - \frac{3}{x^2-5x+4} \end{aligned}$$

Setting now $x^2 - 5x + 5 = y$, we get (after transformations) an inequality $\frac{y^2 - 30y + 209}{(y-1)(y+1)} > 0$, which is equivalent to the inequality

$(y+1)(y-1)(y-11)(y-19) > 0$; the solution of the last inequality is $(-\infty; -1) \cup (1; 11) \cup (19; \infty)$. Solving then the collection of the inequalities

$$x^2 - 5x + 5 < -1, \quad 1 < x^2 - 5x + 5 < 11$$

$$\text{and } x^2 - 5x + 5 > 19,$$

we get the answer; (c) $(-\infty; 1) \cup (3/2; 5/2) \cup (7/2; 4)$. 29. (a) $(-1/2; 1)$; (b) $[-2, 1]$. \bullet See the solution of problem 15 of this section.

30. (a) $(0; 1/3) \cup (3; \infty)$. \bullet Reduce the left-hand part of the inequality to the form $(x + 1/x + 2)^2/(x + 1/x)$ and set $x + 1/x = y$;

(b) $[-(1 + \sqrt{5})/2; -1] \cup [(1 - \sqrt{5})/2; 0] \cup [(\sqrt{5} - 1)/2; 1] \cup [(\sqrt{5} + 1)/2; \infty)$. \bullet Set $x - 1/x = y$. 31. $(-\infty; -6) \cup ((6 - 6\sqrt{26})/5; -4) \cup (-4, 0) \cup (6; (6 + 6\sqrt{26})/5)$.

\bullet Represent the right-hand part of the inequality in the form $(x-6)/(x+6) + (x+6)/(x-6)$. 32. $[0; \sqrt{2}]$.

33. $[-1; -2\sqrt{2}; -3] \cup (1; 3]$. 34. (a) $3x^2 - 12x$; (b) $1/3 - 3x^2$

(c) $4x^3 - 6$; (d) $3x^2 - 2x^3$; (e) $3x^2 + 2x + 3$, (f) $3x^2 - 8x + 3$;

(g) $4x^3 + 9x^2 + 14x + 7$; (h) $(x-1)(x-2)(x-3) +$

$+x(x-2)(x-3) + x(x-1)(x-3) + x(x-1)(x-2)$;

(i) $(1-x^2)/(1+x^2)^2$; (j) $(x^2-2x-2)/(2+x^2)^2$;

(k) $(2x^3 + 9x^2 - 3)/(x+3)^2$; (l) $(2x^4 + 4x^3 - 4x + 4)/(x+1)^3$;

- (m) $(2x^3 - 9x^2 - 24x + 7)/(x - 4)^2$; (n) $3x^2 + 1/(1 - x^2)$;
 (o) $-90(2 - 3x)^{20}$; (p) $32(3x + 1/x^2)(6x^2 - 4/x + 1)^7$;
 (q) $-(8x(x^2 + 1))/(x^2 - 1)^3$; (r) $8(4x^3 - 3x^2 + 10x) \times$
 $\times (x^4 - x^3 + 5x^2 - 2)^7$. 35. (a) 12; (b) 0; (c) 60; (d) 7; (e) 0; (f) 1/2;
 (g) $15a^2 + 2/a^3 - 1$; (h) $-1/(1 + a^2)$; (i) 0; (j) $(-1)^n n!$.
 36. (a) $y = -x$; (b) $y - 2 = 0$; (c) $y = -3x + 5$; (d) $y = -11x - 7$;
 (e) $y = 44x - 84$; (f) $y = 2x - 2$; (g) $y = -4x + 7$.
 37. $(-\sqrt{2}; 2 + \sqrt{2})$ and $(\sqrt{2}; 2 - \sqrt{2})$. 38. $(-2; 52/3)$ and
 $(5; -197/6)$. 39. $(1; 0)$ and $(-1; -4)$. 40. $(3; 9)$. 41. $(0; 1)$. 42. ● Show
 that the inequality $5x^4 + 8 > 0$ holds for any $x \in \mathbb{R}$. 43. (a) $\{1/3; 1/2\}$;
 (b) $\{\sqrt[3]{3}\}$; (c) the function has no critical points; (d) $\{-2; -4/9\}$;
 (e) $\{-1; 0\}$; (f) $\{\sqrt{3}\}$. 44. (a) $\{2\}$; (b) $\{-3; -2; 1\}$; (c) $\{0\}$; (d) $\{-1; 0; 1\}$;
 (e) $\{0\}$. 45. (a) $\{-\sqrt{3}; \sqrt{3}\}$; (b) $\{-3; -2; 2; 3\}$;
 (c) $\{(3 - \sqrt{5})/2; (3 + \sqrt{5})/2\}$; (d) $\{-1; 1\}$; (e) $\{2\}$. 46. (a) $(-2, 1)$,
 (b) $(-\infty; -1/4)$; (c) $(-\sqrt{12}; 0)$ and $(0, \sqrt{12})$, (d) $(-\sqrt{2}, -1)$ and
 $(-1, \sqrt{2})$. 47. (a) $(-\infty; 1/3)$ and $(3; \infty)$; (b) $(1; 3)$; (c) $(0; \infty)$;
 (d) $(-2 - \sqrt{3}; -1)$ and $(-1; \sqrt{3} - 2)$; (e) $(-\infty; -1)$ and $(1; \infty)$.
 48. (a) $x = -5$ is a point of maximum, $x = 3$ is a point of minimum;
 (b) the function has no points of extremum; (c) $x = 1/3$ is a point of
 minimum, $x = 1$ is a point of maximum; (d) $x = -5/4$ is a point
 of minimum; (e) $x = -3$ and $x = 4$ are points of minimum; $x = 1/2$ is
 a point of maximum; (f) $x = 1$ is a point of minimum; (g) $x = 0$ is
 a point of minimum. 49. $8\sqrt{2}$. 50. (a) $y_{\min} = y(-1) = -13$,
 $y_{\max} = y(0) = -3$, (b) $y_{\min} = y(-\sqrt{2}) = -4\sqrt{2}$, $y_{\max} =$
 $= y(1) = 5$; (c) $y_{\min} = y(1/4) = -8\frac{139}{256}$; $y_{\max} = y(2) = 64$;
 (d) $y_{\min} = y(-1) = -7$, $y_{\max} = y(1) = 5$; (e) $y_{\min} = y(-2) =$
 $= 8/3$, $y_{\max} = y(-1) = 3$.

51. On the intervals $(-\infty; 0)$
 and $(2; \infty]$ the function in-
 creases, on the interval $(0; 2)$
 it decreases; $x = 0$ is a point
 of maximum, $x = 2$ is a
 point of minimum.

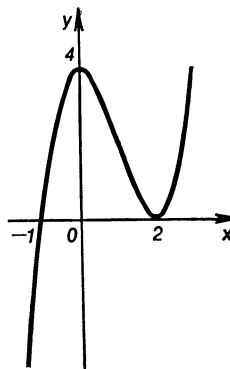

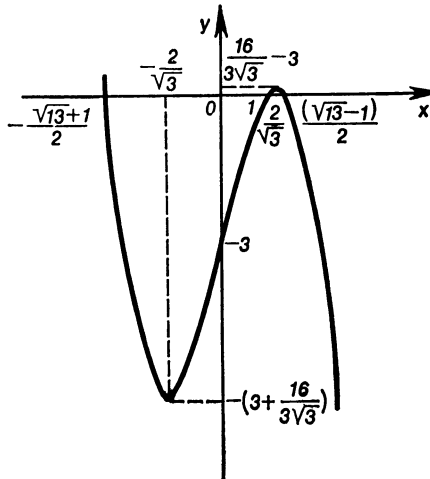

52. On the intervals $(-\infty; -2/\sqrt{3})$ and $(2/\sqrt{3}; \infty)$ the function decreases, on the interval $(-2/\sqrt{3}; 2/\sqrt{3})$ it increases; $x = -2/\sqrt{3}$ is a point of minimum; $x = 2/\sqrt{3}$ is a point of maximum; $y(-2/\sqrt{3}) = -3 - 16/(3\sqrt{3})$; $y(2/\sqrt{3}) = -3 + 16/(3\sqrt{3})$.

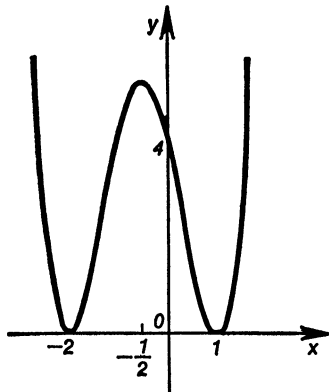

53. On the intervals $(-\infty; -2)$ and $(-1/2; 1)$ the function decreases, on the intervals $(-2; -1/2)$ and $(1; \infty)$ it increases; $x = -2$ and $x = 1$ are points of minimum, $x = -1/2$ is a point of maximum, $y(-2) = y(1) = 0$, $y(-1/2) = 81/16$.

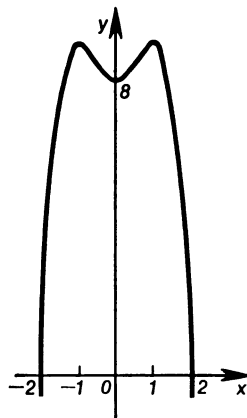

54. On the intervals $(-\infty; -1)$ and $(0; 1)$ the function increases, on the intervals $(-1; 0)$ and $(1; \infty)$ it decreases; $x = -1$ and $x = 1$ are points of maximum, $x = 0$ is a point of minimum; $y(-1) = y(1) = 9$, $y(0) = 8$.

55. On the intervals $(-\infty; -1)$ and $(-\frac{1}{5}; \infty)$ the function increases, on the interval $(-1; -\frac{1}{5})$ it decreases; $x = -1$ is a point of maximum, $x = -\frac{1}{5}$ is a point of minimum; $y(-1) = 0$. $y(-\frac{1}{5}) = -\frac{864}{3125}$.

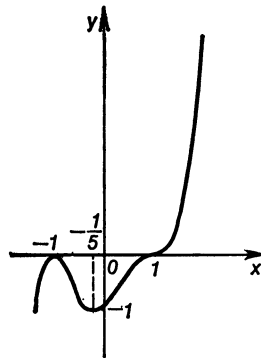

56. On the intervals $(-\infty; -1)$ and $(1; \infty)$ the function increases, on the intervals $(-1; 0)$ and $(0; 1)$ it decreases; $x = -1$ is a point of maximum, $x = 1$ is a point of minimum.

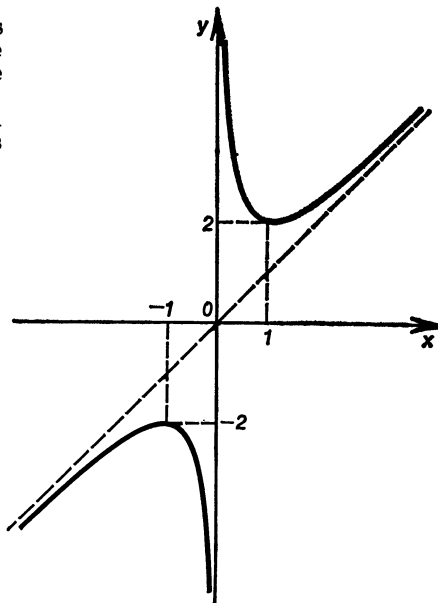

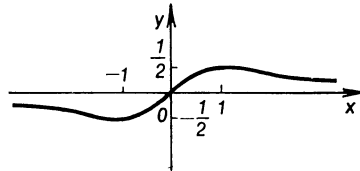

57. On the intervals $(-\infty; -1)$ and $(1; \infty)$ the function decreases, on the interval $(-1; 1)$ it increases; $x = -1$ is a point of minimum, $x = 1$ is a point of maximum.

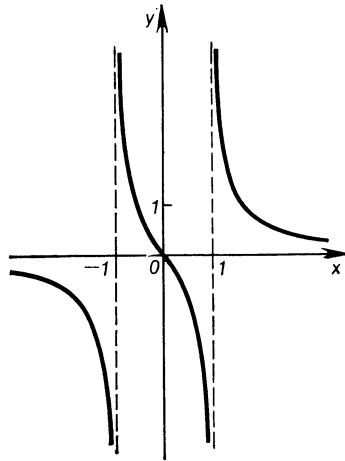

58. The function decreases on the intervals $(-\infty; -1)$, $(-1; 1)$ and $(1; \infty)$.

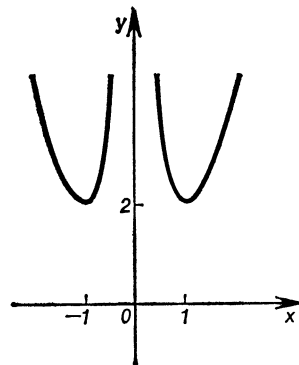

59. On the intervals $(-\infty; -1)$ and $(0; 1)$ the function decreases, on the intervals $(-1; 0)$ and $(1; \infty)$ it increases; $x = -1$ and $x = 1$ are points of minimum.

60. On the intervals $(-\infty; -3)$ and $(3; \infty)$ the function decreases, on the intervals $(-3; -\sqrt{3})$, $(-\sqrt{3}; \sqrt{3})$ and $(\sqrt{3}; 3)$ it increases; $x = -3$ is a point of minimum, $x = 3$ is a point of maximum; $y(-3) = 9$, $y(3) = -9$.

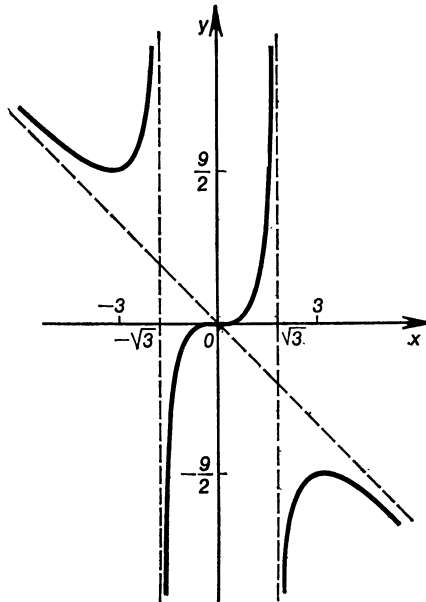

61. On the intervals $(-\infty; 0)$ and $(0; 1/2)$ the function decreases, on the interval $(1/2; \infty)$ it increases; $x = 1/2$ is a point of minimum; $y(1/2) = 3$.

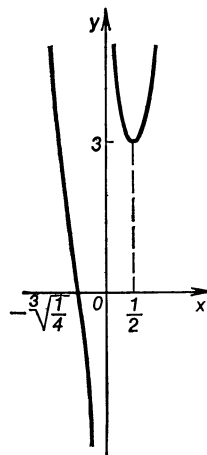

1.5. Linear Systems of Equations and Inequalities

1. (a) $\{(0; 0)\}$; (b) $\{(c, c/2) \mid c \in \mathbb{R}\}$; (c) $\{(c_1, c_2) \mid c_1 \in \mathbb{R}, c_2 \in \mathbb{R}\}$; (d) $\{(c; 0) \mid c \in \mathbb{R}\}$; (e) \emptyset . 2. (a) $\{(1; -1)\}$; (b) $\{(3/4 + 2c, c) \mid c \in \mathbb{R}\}$; (c) \emptyset ; (d) $\{(c; 4c - 1/2) \mid c \in \mathbb{R}\}$ for $a \in \{-1/2\}$ and \emptyset for $a \notin \{-1/2\}$. 3. (a) $(-\infty; -1) \cup (-1; \infty)$; (b) \mathbb{R} ; (c) $(-\infty; -2) \cup (-2; \infty)$. 4. (a) $\{-2/3\}$; (b) $\{1\}$; (c) $\{-1/2\}$. 5. $\{(0; 0)\}$. 6. $\{(0; 0; 9/4); (2; -1; 1)\}$. \blacktriangle Substituting the solution (1; 3) into the system and taking into account the necessary condition for indeterminacy of the system of equations, we obtain a system of equations for a, b and c :

$$\begin{cases} a - 3b = 2a - b, \\ c + 1 + 3c = 10 - a + 3b, \\ a/(c+1) = -b/c \end{cases} \Leftrightarrow \begin{cases} a = -2b, \\ 4c = 9 + 5b, \\ b(c-1) = 0. \end{cases}$$

This system has two solutions; $(0; 0; 9/4)$ and $(2; -1; 1)$. We can make sure by verification that for these values of a, b and c the condition

$$\frac{a}{c+1} = \frac{-b}{c} = \frac{2a-b}{10-a+3b}$$

is satisfied (in the second equation of the system the coefficients are nonzero), i.e. the sufficient condition for indeterminacy of the original system of equations is fulfilled.

7. (a) $\{3\}$; (b) $\{9/4\}$. 8. $\{(-2, -7)\}$. \blacktriangle The second system of equations has a unique solution $(x_0; y_0)$. Therefore, the systems are equivalent if the first system of equations has a unique solution $(x_0; y_0)$. Let us find this solution. Since $x_0 + y_0 = 3$ and $x_0 + 3y_0 = 3$, we find that $x_0 = 3$ and $y_0 = 0$ when we solve the system of these equations. Substituting these values of the variables into the first equation of the second system, we get $a^2 = 4$. Consequently, $a_1 = -2$ and $a_2 = 2$. The substitution $a_1 = -2, x = 3, y = 0$ into the first equation of the first system yields $-2 \cdot 3 + 2 \cdot 0 = b + 1, b = -7$. The value $a = 2$ will not do in this case since then the first system of equations will have an infinite number of solutions. 9. $(-2; 4)$. 10. $(-1 - \sqrt{3}; \infty)$. 11. $\{(-1; 4)\}$. \bullet Set $1/(2x + y - 1) = u$ and $1/(x + 2y - 3) = v$.

12. (a) $\{(3; 1); (-3/2; 5/2); (-9; -5); (9/2; -1/2)\}$; (b) $\{(-3; -2); (-2; -3); (3; 2); (2; 3)\}$. 13. $\{(30; 10)\}$. \blacktriangle Suppose we are given an equation $ax + by = c$, where a, b and c are integers, a and b being coprime, and we have to find all integral x and y satisfying this equation. We assume that by some means (say, by means of selection) we have found one integer solution: $x = \alpha, y = \beta$. Substituting these values into the equation, we get an identity $a\alpha + b\beta = c$. Subtracting this identity, term-by-term, from the given equation and transforming the result, we obtain $a(x - \alpha) + b(y - \beta) = 0, ax = a\alpha - b(y - \beta), x = \alpha - (b(y - \beta))/a$. For x to be an integer, it is necessary and sufficient that the expression $(b(y - \beta))/a$ be an integral number (α is an integer), i.e. $y - \beta$ must be divisible by a . Designating the integral quotient from the division of $y - \beta$ by a as $t, t \in \mathbb{Z}$, we get $y = \beta + at$ and then $x = \alpha - bt$. Thus, all solutions can be described by the formulas $x = \alpha - bt, y = \beta + at, t \in \mathbb{Z}$. Let us write the solutions of the given problem in the form $x = \alpha - 31t, y = \beta + 23t, t \in \mathbb{Z}$, and find some special solution $(\alpha; \beta)$. We rewrite the original equation in the form $23x = 1000 - 31y$ and solve it with respect to $x: x = 43 - y + (11 - 8y)/23$. It follows from this notation that $(11 - 8y)/23$ must be an integer, i.e. $(11 - 8y)/23 = u, u \in \mathbb{Z}$,

14. (a)

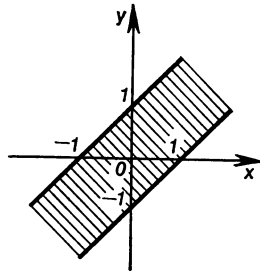

14. (b)

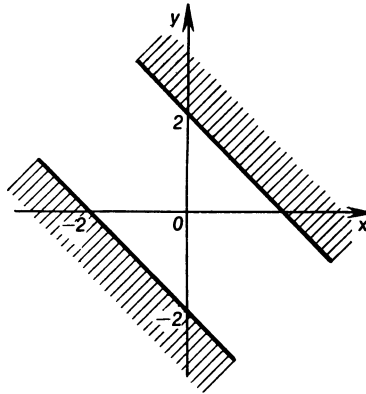

14. (c)

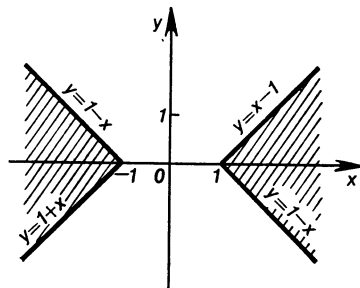

14. (d)

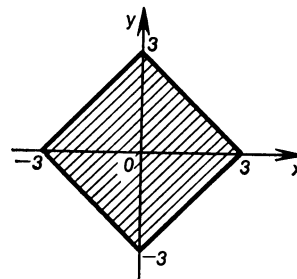

14. (e)

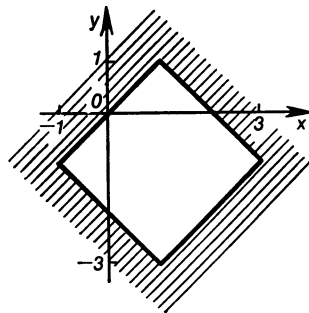

14. (f)

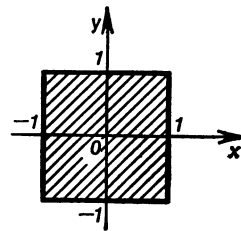

or $8y = 11 - 23u$. Now we can find y : $y = (11 - 24u + u)/8 = 1 - 3u + (u + 3)/8$. Setting $u = -3$, we get a special solution $\beta = 1 - 3(-3) = 10$ and $\alpha = 43 - 10 - 3 = 30$. Thus, the solution of the given equation has the form $x = 30 - 31t$, $y = 10 + 23t$, $t \in \mathbb{Z}$. Solving the system of inequalities $30 - 31t > 0$ and $10 + 23t > 0$ in integers, we find that $t = 0$, i.e. $x = 30$, $y = 10$.

15. $\{(2;2); (3;2); (4;2)\}$

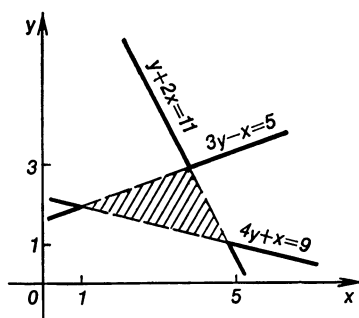

16. $(-(1 + \sqrt{13})/2; -2)$. 17. $\{(1; 2; 3)\}$. 18. \emptyset . 19. $\{(2; -3; 6)\}$.
 20. $\{(-2t - 2; 3t + 1; 2t + 3) \mid t \in \mathbb{R}\}$. ● Set $-(x + 2)/2 = (y - 1)/3 = (z - 3)/2 = t$. 21. (a) 25. ▲ 1st method. We multiply the equations of the system by α and β ($\alpha\beta \neq 0$) and sum them up:

$$(2\alpha/3 + \beta)x + (4\alpha/5 + \beta)y + (5\alpha/6 + \beta)z = 61\alpha + 79\beta.$$

We require that the following equalities should hold simultaneously: $2\alpha/3 + \beta = 0$, $4\alpha/5 + \beta = 2/5$; $5\alpha/6 + \beta = 1/2$. Then we have $S = 2y/5 + z/2 = 61\alpha + 79\beta$. The values of α and β can be found from the system of equations

$$\begin{cases} 2\alpha/3 + \beta = 0, \\ 4\alpha/5 + \beta = 2/5, \\ 5\alpha/6 + \beta = 1/2. \end{cases}$$

This system is consistent and has a solution $\alpha = 3$, $\beta = -2$; $S = 61 \cdot 3 - 79 \cdot 2 = 25$.

2nd method. Let us represent the original system of equations in the form

$$\begin{cases} 2x/3 + 4y/5 = 61 - 5z/6, \\ x + y = 79 - z \end{cases}$$

and solve it with respect to x , y , assuming z to be known. Multiplying the second equation by $-2/3$ and adding it to the first equation, we obtain

$$\begin{aligned} \left(\frac{4}{5} - \frac{2}{3}\right)y &= \left(61 - \frac{79 \cdot 2}{3}\right) - \left(\frac{5}{6} - \frac{2}{3}\right)z; \\ \frac{2}{15}y &= \frac{25}{3} - \frac{z}{6}; \quad \frac{2}{5}y = 25 - \frac{z}{2}. \end{aligned}$$

Now we find $S = 2y/5 + z/2 = 25 - z/2 + z/2 = 25$;
 (b) $\{(27; 10; 42)\}$. \blacktriangle Since, by the hypothesis, x , y and z are natural numbers, it follows that $x = 3k$, $y = 5l$ and $z = 6m$, where $k \in \mathbb{N}$, $l \in \mathbb{N}$, $m \in \mathbb{N}$. The system of equations can now be represented in the form

$$\begin{cases} 4l + 5m = 61 - 2k, \\ 5l + 6m = 79 - 3k. \end{cases}$$

Hence we find $l = 29 - 3k$ and $m = 2k - 11$. The greatest value of $k \in \mathbb{N}$ satisfying the system of inequalities

$$\begin{cases} k > 0, \\ 29 - 3k > 0, \\ 2k - 11 > 0 \end{cases}$$

is $k = 9$. Now we can find the solution of the system: $x = 3 \cdot 9 = 27$, $y = (29 - 3 \cdot 9) \cdot 5 = 10$, $z = 6(2 \cdot 9 - 11) = 42$. **22.** $a < 0$.

\bullet Exclude b and c from the system of inequalities. **23.** A regular octahedron

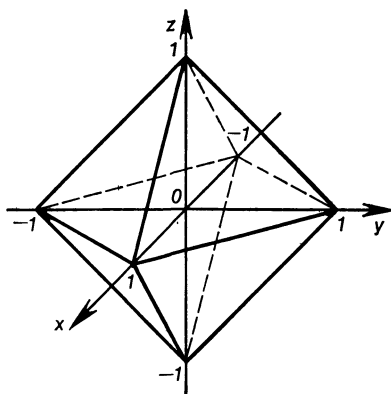

1.6. Systems of Equations and Inequalities in Several Higher-Degree Variables

1. (a) $\{(-4/9; 20/9); (2; 1)\}$; (b) $\{(-1; 3); (71/24; -25/7)\}$;
 (c) $\{(51; 24.5)\}$. \bullet Factorize the left-hand part of the first equation of the system; (d) $\{(-19.6; 5.2); (-14; 8)\}$. \bullet Represent the left-hand part of the first equation of the system in the form $(x + 3y)^2 - 6(x + 3y) - 40$ and set $x + 3y = t$. **2.** (a) $\{(2; 3); (3; 2)\}$. \blacktriangle Using the converse of the Vieta theorem, we get a quadratic equation $t^2 - 5t + 6 = 0$, whose roots are $t_1 = 2$ and $t_2 = 3$. The given system possesses a remarkable property: if it has one solution $(t_1; t_2)$, then the ordered pair of numbers $(t_2; t_1)$ is also its solution. Thus, the set of solutions of the original system is $\{(2; 3); (3; 2)\}$;
 (b) $\{(4; -1); (1, -4)\}$. \bullet Set $-y = z$; (c) $\{(1; 3); (3; 1)\}$. \bullet Use the identity $2xy = (x + y)^2 - (x^2 + y^2)$; (e) $\{(-1/2; -1/3); (1/3; 1/2)\}$.
 \bullet Set $1/x = u$, $-1/y = v$; (e) $\{(-1; 2); (2; -1)\}$. \blacktriangle Using the identity

$(x + y)^3 = x^3 + y^3 + 3xy(x + y)$, we find xy : $1^3 = 7 + 3xy \cdot 1 \Rightarrow xy = -2$. Thus, the given system is equivalent to the system

$$\begin{cases} x + y = 1, \\ xy = -2. \end{cases}$$

Solving now the auxiliary quadratic equation $t^2 - t - 2 = 0$, we find all solutions of the original system; (f) $\{(1; 2); (2; 1)\}$. ● Use the equality $(x + y)^4 = x^4 + y^4 + 4(x + y)^2 xy - 2x^2 y^2$ to find $xy = x$; (g) $\{(3; 2); (2; 3)\}$; (h) $\{(-1; -4); (4; 1)\}$. 3. (a) $\{(-3; 4); (4; -3)\}$; (b) $\{(5 + \sqrt{28}; -5 + \sqrt{28}); (5 - \sqrt{28}; -5 - \sqrt{28})\}$; (5; 2); (-2, -5); (c) $\{(0.6; 0.3); (0.4; 0.5)\}$; (d) $\{(-1; 2); (-1/4; -1/4)\}$; (e) $\{(2; 1); (1; 2); ((5 + \sqrt{21})/2; (5 - \sqrt{21})/2); ((5 - \sqrt{21})/2; (5 + \sqrt{21})/2)\}$. ● Set $x + y = u$, $xy = v$, and then $-u + v = z$, $uv = t$. 4. (a) $\{(-25 + 5\sqrt{61})/9; (5 + \sqrt{61})/9; ((5\sqrt{61} - 25)/9; (5 - \sqrt{61})/9); (-6; -4/3); (3/2; 1/3)\}$. ▲ Setting $x = yt$, we reduce the first equation of the system to the form $y^2(2t^2 + t - 45) = 0$. Solving this equation, we find $t_1 = 9/2$ and $t_2 = -5$ ($y = 0$ does not satisfy the system). Thus, the original system of equations is equivalent to the collection of the systems

$$\begin{cases} 2x + 9y^2 = 4, \\ x = 9y/2, \end{cases} \quad \begin{cases} 2x + 9y^2 = 4, \\ x = -5y, \end{cases}$$

solving which we get the answer; (b) $\{(-1; 3); (1; -3); (16/\sqrt{11}, 1/\sqrt{11}); (-16/\sqrt{11}, -1/\sqrt{11})\}$. ● Multiply the first equation of the system by 3 and the second equation by -16 and add the results. Then set $x = yt$; (c) $\{(1; 2); (-1; -2); (\sqrt{2}; \sqrt{2}); (-\sqrt{2}; -\sqrt{2})\}$;

$$(d) \left\{ \left(\frac{2 + \sqrt{19}}{\sqrt[3]{14 + 4\sqrt{19}}}; -\frac{3}{\sqrt[3]{14 + 4\sqrt{19}}} \right); \left(\frac{\sqrt{19} - 2}{\sqrt[3]{4\sqrt{19} - 14}}; \frac{3}{\sqrt[3]{4\sqrt{19} - 14}} \right); (2, -1) \right\}.$$

5. (a) $\{(2; 1)\}$. ▲ Multiplying the second equation of the system by 2 and then by -2 and adding it to the first equation, we get a system of equations which is equivalent to the original system:

$$\begin{aligned} & \left(\begin{cases} 16x^2 + 8xy + y^2 - 72x - 18y + 81 = 0, \\ 4x^2 - 12xy + 9y^2 - 4x + 6y + 1 = 0 \end{cases} \right) \\ \Leftrightarrow & \left(\begin{cases} (4x + y)^2 - 18(4x + y) + 81 = 0, \\ (2x - 3y)^2 - 2(2x - 3y) + 1 = 0 \end{cases} \right) \Leftrightarrow \left(\begin{cases} 4x + y = 9, \\ 2x - 3y = 1 \end{cases} \right). \end{aligned}$$

It is easy to find the solution of this system (the system being linear): $\{(2; 1)\}$; (b) $\{(0; 1/\sqrt{3}); (0; -1/\sqrt{3}); (1; 1); (-1; -1)\}$. 6. (a) $\{(2/7; -9/7); (1; 3)\}$. ● Multiply the equations and set $x + y = t$; (b) $\{(2; 6); (1; 3)\}$. 7. (a) $\{(2\sqrt{2}; -\sqrt{2}); (-2\sqrt{2}; \sqrt{2})\}$; (b) $\{(\sqrt{6}; \sqrt{6}/3); (-\sqrt{6}; -\sqrt{6}/3)\}$. 8. $\{3; 7/2\}; (-3; -7/2)\}$.

9. $\{(3; 1)\}$. 10. $a = -1$. The required point is $(0, -1)$. 11. (a) $\{(1; -5)\}$.
 (b) $\{(1; -3)\}$; (c) $\{(-3; 1)\}$ for $a \in \{-2\}$; \emptyset for $a \notin \{-2\}$.

12. (a) $\{(2; 1; -1); (31/15; 17/15; -2/3)\}$; (b) $\{(1; 2; 2); (2; 1; 1)\}$.

13. $\{(3; -2; 1); (-2; 3; 1); \left(\frac{3+\sqrt{17}}{2}; \frac{3-\sqrt{17}}{2}, -1\right); \left(\frac{3-\sqrt{17}}{2}; \frac{3+\sqrt{17}}{2}; -1\right)\}$.

14. $\{(3; 1; -2); (-5; -3; 0)\}$. ● In the first equation of the system express y in terms of x and substitute it into the second equation.
 15. $\{(3; 5; -1); (-3; -5; 1)\}$.

16. $\{(2; -1; 3); (-2; 1; -3); \left(-\frac{7}{\sqrt{13}}; \frac{5}{\sqrt{13}}; -\frac{11}{\sqrt{13}}\right); \left(\frac{7}{\sqrt{13}}; -\frac{5}{\sqrt{13}}; \frac{11}{\sqrt{13}}\right)\}$. 17. $\{(-4; -3; 1); (4; 3; -1)\}$.

18. $\left\{\left(\frac{1}{2}; \frac{1}{3}; \frac{1}{4}\right)\right\}$. ● Reduce the equations of the system to the form

$$\frac{x+y}{xy} = 5 = \frac{1}{x} + \frac{1}{y}, \quad \frac{y+z}{yz} = 7 = \frac{1}{y} + \frac{1}{z}, \quad \frac{x+z}{xz} = 6 = \frac{1}{x} + \frac{1}{z}.$$

19. $\{(-1; 1; 0); (1; -1; 0)\}$. 20. $\{(3; 3; 3)\}$.

21. $\{(1; 5; 0); (1; -5; 0); (-1; 5; 0); (-1; -5; 0)\}$. ● Set $y - z = t$.

22. (a)

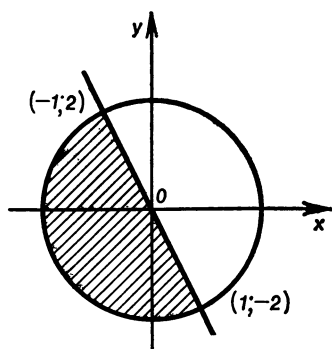

22. (b)

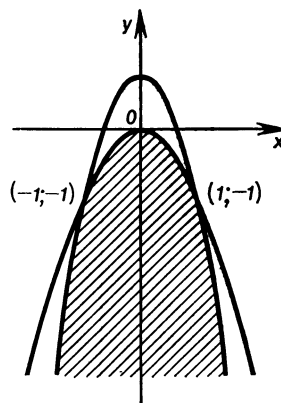

23. (a)

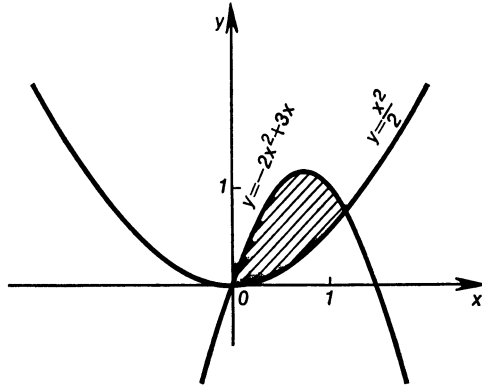

23. (b)

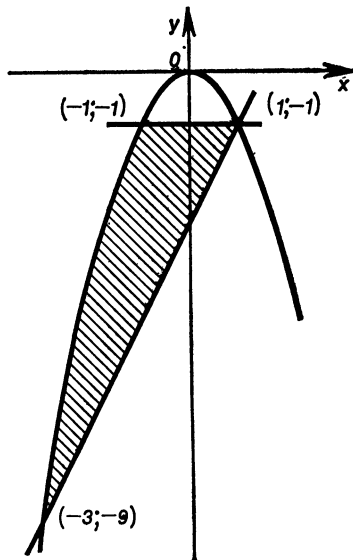

23. (c)

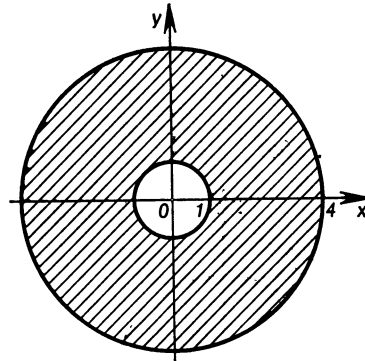

Chapter 2

TRANSCENDENTAL FUNCTIONS, EQUATIONS AND INEQUALITIES

2.1. Irrational Equations and Inequalities

1. $\{a^2 - 1\}$ for $a \in [0; \infty)$, \emptyset for $a \in (-\infty; 0)$. 2. $\{(a - 3)/2\}$ for $a \in [-3; \infty)$, \emptyset for $a \in (-\infty; -3)$. 3. $\{3\}$. 4. (a) $\{-3\}$. \blacktriangle We set $\sqrt{22 - x} = y \geq 0$ and then we have $x = 22 - y^2$, and the original equation is equivalent to the system

$$\begin{cases} 11 + 2(22 - y^2) = y, \\ y \geq 0. \end{cases}$$

The solution of the system is $y = 5$. Now we can find $x = 22 - 5^2 = -3$; (b) $\{28\}$; (c) $\{4\}$; (d) $\{0; 4/3\}$. 5. (a) $\{6\}$. \blacktriangle The permissible values of the variable x in the given equation are $x \in [2; \infty)$. Multiplying both parts of the equation by $\sqrt{x+10} - \sqrt{x-2} \neq 0$ (with due account of the indicated restrictions), we get the system

$$\begin{cases} \sqrt{x+10} - \sqrt{x-2} = 2, \\ \sqrt{x+10} + \sqrt{x-2} = 6. \end{cases}$$

Now we subtract the first equation from the second: $\sqrt{x-2} = 2$; hence we find: $x-2=2^2$, $x=6$. *Remark.* Since $x+10 > x-2$ in the domain of definition of this equation, we have $\sqrt{x+10} > \sqrt{x-2}$ and $\sqrt{x+10} \geq 0$; (b) \emptyset ; (c) $\{-1\}$; (d) $\{12\}$; (e) $\left\{-\frac{1}{4} \left(\frac{1}{a} - a\right)^2\right\}$; $\frac{1}{4} \left(\frac{1}{a} - a\right)^2$ for $a \in (0; 1]$, \emptyset for $a \in (-\infty; 0] \cup (1; \infty)$; (f) $\{-6, 1\}$. \bullet Multiply both parts of the equation by $\sqrt{x^2+5x+3} + \sqrt{x^2+5x-2}$. 6. (a) $\{-1; 3\}$. \blacktriangle *1st method.* The original equation is equivalent to the equation

$$\sqrt{2x+3} = 1 + \sqrt{x+1}. \quad (1)$$

We square both parts of equation (1) and single out the radical:

$$x+1 = 2\sqrt{x+1}. \quad (2)$$

We solve equation (2) by the method explained in the solution of problem 4 (a): we set $\sqrt{x+1} = y \geq 0$ and pass to the system

$$\begin{cases} y^2 = 2y, \\ y \geq 0 \end{cases}$$

and hence find the roots: $x_1 = -1$, $x_2 = 3$. Since we have squared equation (1), the roots of equation (2) must be checked. Verification shows that they both satisfy the original equation.

2nd method. Let us multiply both parts of the equation by the expression conjugate to the left-hand side of the equation $\sqrt{2x+3} + \sqrt{x+1}$ (in the domain of definition of the equation ($x \geq -1$) this expression is nonzero). As a result we get a system of equations with respect to $\sqrt{2x+3} \geq 0$ and $\sqrt{x+1} \geq 0$,

$$\begin{cases} \sqrt{2x+3} - \sqrt{x+1} = 1, \\ \sqrt{2x+3} + \sqrt{x+1} = x+2, \end{cases}$$

from which it is sufficient to find $\sqrt{x+1}$ ($\sqrt{2x+3} > \sqrt{x+1} > 0$) in the domain of definition. We have an equation $2\sqrt{x+1} = x+1$, which we solve by the method described above; (b) {3}; (c) {2}; (d) {5}; (e) {20}; (f) $\{-4/3\}$; (g) $\{-1; 0\}$. ● Set $x^2 + x + 1 = y$; (h) {5}. 7. (a) {16}. ● Set $\sqrt{x} = y$; (b) {9}; (c) $\{-3; 6\}$. ● Set $\sqrt{x^2 - 3x + 7} = y$; (d) $\{-9/2; 3\}$; (e) {1}. ● Set $\sqrt{x}\sqrt{x^2 + 15} = y$; (f) $\{5/3\}$. ● Set $\sqrt{(x+1)/(x-1)} = y$; (g) $\{5a/3\}$ for $a \neq 0$, $(-\infty; 0) \cup (0; \infty)$ for $a = 0$; (h) {1}. ● Set $\sqrt{2-x} + 3 = y$; (i) {3; $9(9 - \sqrt{97})/8$ }. ● Set $\sqrt{1+x} = y$ and solve the equation $4x^2 + 12xy - 27y^2 = 0$ for x . 8. $\{5 \pm a\sqrt{8-a^2}/2\}$ for $a \in [2; 2\sqrt{2}]$, \emptyset for $a \in (-\infty; 2) \cup (2\sqrt{2}; \infty)$. ▲ Suppose $\sqrt{7-x} = u$, $\sqrt{x-3} = v$. We have a system of equations

$$\begin{cases} u+v=a, \\ 7-x+x-3=u^2+v^2=4 \quad (u \geq 0, v \geq 0); \end{cases}$$

solving this system by means of the substitution $u = a - v$, we obtain

$$\begin{cases} u_1 = (a + \sqrt{8-a^2})/2, & u_2 = (a - \sqrt{8-a^2})/2; \\ v_1 = (a - \sqrt{8-a^2})/2; & v_2 = (a + \sqrt{8-a^2})/2. \end{cases}$$

For the equation to have real roots, the following system of inequalities must be satisfied:

$$\begin{cases} 8-a^2 \geq 0, \\ a - \sqrt{8-a^2} \geq 0. \end{cases}$$

The values $a \in [2; 2\sqrt{2}]$ are the solution of the system. Now we can find the answer: $x-3 = v^2$, $x = 3 + v^2 = 5 \pm a\sqrt{8-a^2}/2$. 9. (a) $D(y) = [-1; 2]$; $E(y) = [\sqrt{3}; \sqrt{6}]$. ● To find the set of values of the function, solve the equation $\sqrt{2-x} + \sqrt{1+x} = y$ and find $D(y)$; (b) $D(y) = [-1/2; 3/2]$; $E(y) = [0; 2]$. 10. {3}. ▲ Setting $\sqrt[4]{x-2} = u \geq 0$, $\sqrt[4]{4-x} = v \geq 0$, we get a system

of equations

$$\begin{cases} u+v=2, \\ u^4+v^4=2. \end{cases}$$

Raising the first equation to the fourth degree and taking the second equation into account, we obtain $uv(2(u+v)^2 - uv) = 7$, and since $u+v=2$, we have $(uv)^2 - 8(uv) + 7 = 0$, whence we get $(uv)_1 = 1$; $(uv)_2 = 7$. Furthermore, to find the solutions of the original equation, we have to solve two systems of equations:

$$\begin{cases} u+v=2, \\ uv=1, \end{cases} \quad \begin{cases} u+v=2, \\ uv=7. \end{cases}$$

The first system has a solution $u = v = 1$. Now we obtain $\sqrt[4]{x-2} = u = 1$, $x = 3$. The second system has no real solutions.
11. $\{(2a+1)/(a-2)\}$ for $a \in (-\infty; 1/3] \cup (2; \infty)$, \emptyset for $a \in (1/3; 2]$.
▲ The original equation is equivalent to the system

$$\begin{cases} x^2 + ax - 2a = (x+1)^2, \\ x+1 \geq 0. \end{cases}$$

Solving the equation of the system and selecting the values of a for which the inequality $x+1 \geq 0$ is satisfied, we get the answer.
12. $\{a+1 + \sqrt{2a}; a+1 - \sqrt{2a}\}$ for $a \in [0; 1/2]$, $\{a+1 + \sqrt{2a}\}$ for $a \in (1/2; \infty)$, \emptyset for $a \in (-\infty; 0)$. 13. $(-\infty; 0)$ for $a = 0$; $\{0; 3a/4\}$ for $a \in (0, \infty)$, \emptyset for $a \in (-\infty; 0)$. 14. $\{a^2 + a; a^2 - a + 1\}$ for $a \in [0; 1]$, $\{a^2 + a\}$ for $a \in (1; \infty)$, \emptyset for $a \in (-\infty; 0)$. 15. $\{0\}$ for $a = 1$, \emptyset for $a \neq 1$. 16. $\{-1\} \cup [2; \infty)$. 17. $(0.5; 2]$. 18. $[-\sqrt{3}; 0] \cup (0; 2]$. 19. $[-0.5; \infty)$ for $a \in [1; \infty)$, $[-0.5; -0.5(1 - 1/(1-a)^2)]$ for $a \in (-\infty; 1)$. 20. $(1; 3]$. 21. $[-2; \infty)$ for $a \in [-2; \infty)$, \emptyset for $a \in (-\infty; -2)$. 22. (a) $(-5/8; 2.4]$. ▲ Suppose $\sqrt{24-10x} = y \geq 0$; then $x = 0.1(24 - y^2)$. The original inequality is equivalent to the system

$$\begin{cases} y > 3 - \frac{4}{10}(24 - y^2), \\ y \geq 0. \end{cases}$$

The solution of this system are the values of y satisfying the inequality $0 \leq y < 5.5$. Solving now the inequality $0 \leq \sqrt{24-10x} < 5.5$, we get the answer; (b) $((\sqrt{5}-1)/2; 1]$; (c) $(3; 4.8]$; (d) $(1; 2/\sqrt{3}]$.
● Set $1/x = t$; (e) $((\sqrt{13}-5)/2, 1]$. 23. (a) $[3; 12]$; (b) $[-2; \infty)$; (c) $((5 - \sqrt{13})/6; \infty)$; (d) $(8/3; \infty)$. 24. $\left[2; \frac{2}{3}\sqrt{21}\right)$.
25. (a) $[3/2; 2] \cup (2; 26)$. ● Multiply the numerator and the denominator of the fraction by $\sqrt{2x-3} + 1$; (b) $(-2; 1) \cup (1; \infty)$. ● Multiply both parts of the inequality by $2 + \sqrt{x+3}$; (c) $[0; 1/2]$. ▲ Only $x \geq 0$ can be solutions of the given inequality. Multiplying both parts

of the inequality by $\sqrt{x+2} + \sqrt{5x} > 0$ and transferring all its terms to the right-hand side, we get the inequality

$$0 > (4x-2)(1 + \sqrt{x+2} + \sqrt{5x}). \quad (1)$$

The term $(1 + \sqrt{x+2} + \sqrt{5x})$ is positive and, therefore, inequality (1) is satisfied if $4x - 2 < 0$, i.e. $x < 1/2$. It remains to solve the system of inequalities

$$\begin{cases} x \geq 0, \\ x < 1/2; \end{cases}$$

(d) $(1/2; \infty)$. 26. $[-4; 0) \cup (4; 6)$. \blacktriangle The given inequality can only be satisfied by those values of x for which $24 + 2x - x^2 \geq 0$ and $x \neq 0$. Hence we obtain two intervals: $[-4; 0)$ and $(0; 6]$. It is evident that $x \in [-4; 0)$ are solutions of the inequality since at these values of x the left-hand part of the inequality is negative and the right-hand part is positive. For the second interval we have $\sqrt{24 + 2x - x^2} < x$ or (after squaring both parts of the inequality) $x^2 - x - 12 > 0$, whence we get $x \in (-\infty; -3) \cup (4; \infty)$. Consequently, $(-\infty; -3) \cap (0; 6] = \emptyset$, $(4; \infty) \cap (0; 6] = (4; 6]$. 27. $[-1; -3/4]$. \blacktriangle Setting $\sqrt{x+1} + \sqrt{x+3} = y$, we reduce the original inequality to the form $y^2 - 3y + 2 < 0$. Solving it, we find $1 < y < 2$ or $1 < \sqrt{x+1} + \sqrt{x+3} < 2$, which is equivalent to the system

$$\begin{cases} \sqrt{x+1} + \sqrt{x+3} > 1, \\ \sqrt{x+1} + \sqrt{x+3} < 2, \\ x \geq -1. \end{cases}$$

Let us solve the first inequality of the system. Squaring it and transforming, we get an inequality $2\sqrt{x^2 + 4x + 3} > -3 - 2x$, whose right-hand side is negative for $x \geq -1$ and the left-hand side is nonnegative. Therefore, all $x \in [-1; \infty)$ are solutions of this inequality. After squaring and collecting terms, the second inequality assumes the form $\sqrt{x^2 + 4x + 3} < -x$. It can have solutions only for $-1 \leq x \leq 0$. Squaring the inequality, we get $4x + 3 < 0$, or $x < -3/4$. Taking the first inequality into account, we get the answer. 28. $2k, k \in \mathbb{Z}$. 29. No,

there is not. 30. (a) $1/(2\sqrt{x})$. $\blacktriangle f'(x) = \lim_{\Delta x \rightarrow 0} \frac{\sqrt{x+\Delta x} - \sqrt{x}}{\Delta x} =$
 $= \lim_{\Delta x \rightarrow 0} \frac{(x+\Delta x) - x}{\Delta x(\sqrt{x+\Delta x} + \sqrt{x})} = \lim_{\Delta x \rightarrow 0} \frac{1}{\sqrt{x+\Delta x} + \sqrt{x}} = \frac{1}{2\sqrt{x}} =$
 $= \frac{1}{2\sqrt{x}}$ (the function $f(x) = \sqrt{x}$ is continuous at the point x ,

$x > 0$ and, therefore, $\lim_{\Delta x \rightarrow 0} (\sqrt{x+\Delta x} + \sqrt{x}) = 2\sqrt{x}$); (b) $1/\sqrt[3]{x^3}$.

● Use the identity $\sqrt[3]{a} - \sqrt[3]{b} = (a-b)/(\sqrt[3]{a^2} + \sqrt[3]{ab} + \sqrt[3]{b^2})$; (c) $1/4\sqrt[4]{x^3}$.

● Use the identity $\sqrt[4]{a} - \sqrt[4]{b} = (a-b)/((\sqrt[4]{a} + \sqrt[4]{b})(\sqrt{a} + \sqrt{b}))$.

31. (a) $(1/2\sqrt{x})(1+1/x)$; (b) $5x\sqrt{x}/2$; (c) $3.5x^2\sqrt{x-1} + 1/(2\sqrt{x})$;

(d) $(1 + \sqrt{2} + \sqrt{3} + 2\sqrt{2x} + 2\sqrt{3x} + 2\sqrt{6x} + 3x\sqrt{6})/2\sqrt{x}$; (e) $(1 - \sqrt{2})/(2\sqrt{x}(1 + \sqrt{2x}))$; (f) $-x/\sqrt{1-x^2}$; (g) $-4(1-2)\sqrt{x^3}/\sqrt{x}$;
 (h) $(1/(2\sqrt{x} + \sqrt{x}))(1 + 1/(2\sqrt{x}))$. 32. (a) 9; (b) $-\sqrt{3}/3$; (c) 0.
 33. $x - 4y + 4 = 0$; (b) $y + 1 = 0$; (c) $y + x - 4 = 0$.
 (d) $y - 3x + 3 = 0$. 34. (0; 4/27) and $(-2/27; 0)$. 35. (a) {4};
 (b) {1}; (c) {3}; (d) the function has no critical points; (e) {1/3}; (f) the
 function has no critical points. 36. (a) (4; ∞); (b) (1/2; ∞);
 (c) $(\sqrt{7} - 2; \infty)$; (d) (0; 9) \cup (9; ∞); (e) (0, 9). 37. (a) $(-\infty; 2.5)$;
 (b) (1; 2); (c) $(-\infty; 1/4)$; (e) (0; ∞) (e) (0; 1). 38. \blacktriangle Let us consider the
 function $f(x) = 2\sqrt{x} + 1/x - 3$. Its derivative $f'(x) = 1/\sqrt{x} -$
 $1/x^2$ exists on the given interval and is positive everywhere; $f(1) = 0$.
 Consequently, $f(x) > 0$ on that interval and this means that $2\sqrt{x} >$
 $> 1/x - 3$. *Remark.* The proof can be carried out by elementary
 techniques, representing $f(x)$ as $f(x) = (\sqrt{x} - 1)^2(2\sqrt{x} + 1)/x$.
 39. (a) $\max_{[-6;8]} f(x) = f(0) = 10$, $\min_{[-6;8]} f(x) = f(8) = 6$;
 (b) $\max_{[0;4]} f(x) = f(4) = 8$, $\min_{[0;4]} f(x) = f(0) = 0$; (c) $\max_{[0;3]} f(x) =$
 $= f(3) = \sqrt[3]{9}$, $\min_{[0;3]} f(x) = f(0) = f(2) = 0$. 40. The point $x = 1$
 is point of minimum of the function, which does not have points of
 maximum; $\max_{[0;3]} f(x) = f(3) = 4\sqrt{6}$, $\min_{[0;3]} f(x) = f(1) = 0$.

41. (a) The point $x = -1$ is a point of minimum, $x = 1$ is a point of maximum;

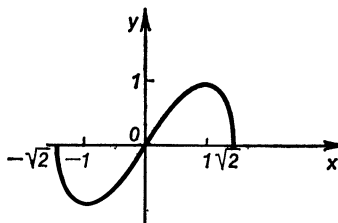

(b) the point $x = 8/27$ is a point of maximum, $x = 0$ is a point of minimum.

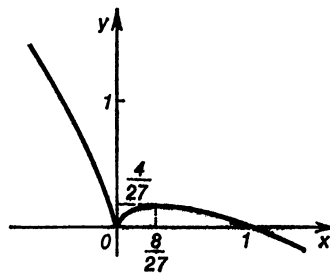

2.2. Systems of Irrational Equations and Inequalities

1. (a) $\{(16; 30)\}$. ● Set $1/\sqrt{x-7}=u$, $1/\sqrt{y+6}=v$; (b) $\{(41; 40)\}$.
 2. (a) $\{(c; c-1) \mid c \in \mathbb{R}, \text{ except for } c=1/2\}$; (b) $\{-1/2; -2/5\}$; (5; 4).
 3. $\{(\sqrt{(3\sqrt{109}+9)}/2; \sqrt{(3\sqrt{109}-9)}/2); (-5; -3)\}$. ● Reduce the first equation of the system to the form $x^2-y^2+\sqrt{x^2-y^2}=12$ for $x-y > 0$ and $x^2-y^2-\sqrt{x^2-y^2}=12$ for $x-y < 0$.
 4. $\{(0; a+\sqrt{a^2+3})\}$ for $a \in (-\infty; \sqrt{3})$, $\{(0; a+\sqrt{a^2+3}); (0; -a-\sqrt{a^2-3})\}$; $\{(0; \sqrt{a^2-3}-a)\}$ for $a \in [\sqrt{3}; \infty)$.
 5. $\{-1/4\} \cup [0; \infty)$. 6. $[2; 2\sqrt{2}]$. 7. $\{1\}$.

8.

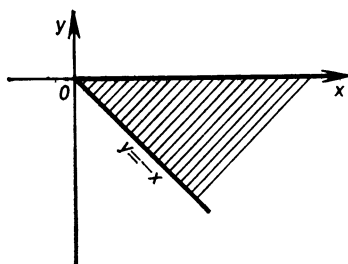

9.

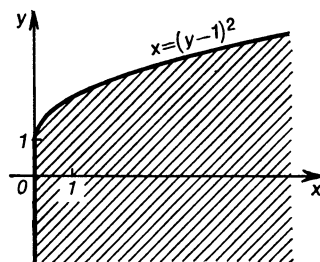

10.

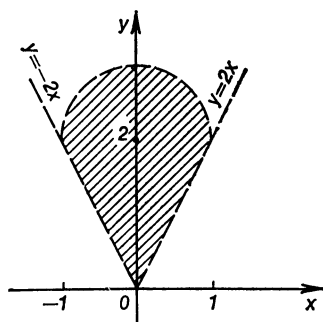

**2.3. An Exponential and a Logarithmic Functions,
Exponential and Logarithmic Equations,
Systems of Equations and Inequalities**

1. The numbers given in (b), (c), (e), (i), (j), (k), (l) exceed unity.
 2. (a) $y > x$; (b) $y > x$; (c) $x > y$; (d) $x > y$. 3. $2^{300} < 3^{200}$. $\blacktriangle 2^{300} = (2^3)^{100} = 8^{100}$, $3^{200} = (3^2)^{100} = 9^{100}$; consequently, $9^{100} > 8^{100}$.
 4. (a) 9; (b) $\ln 3$; (c) $\ln |a|$; (d) $4 \log_a |b|$; (e) 3; (f) 2; (g) 1; (h) 2;
 (i) 0. $\blacktriangle a \sqrt{\log_a b} = (a \sqrt{\log_a b})^{1/\sqrt{\log_a b}} = b \sqrt{\log_b a}$, and, hence, $b \sqrt{\log_b a} - b \sqrt{\log_b a} = 0$. 5. (a) $3(1-c-d)$; (b) $(5-d)/(2c-2d+cd+1)$;
 (c) $5c-6d-4$. \blacktriangle Let us represent the decimal fraction 0.175 as an ordinary fraction; $0.175 = 175/1000 = 7/40 = 7/(2^3 \cdot 10)$. Thus, $\log 0.175 = \log 7 - 2 \log 2 - 1$. The problem reduced to finding $\log 2$ and $\log 7$. We have $\log 196 = \log 2^2 \cdot 7^2 = 2 \log 2 + 2 \log 7 = c$ (1), $\log 56 = \log 2^3 \cdot 7 = 3 \log 2 + \log 7 = d$ (2). Solving the system of equations (1) and (2) with respect to $\log 2$ and $\log 7$, we get $\log 2 = (2d-c)/4$, $\log 7 = (3c-2d)/4$; therefore, $\log (0.175)^4 = = 4(\log 7 - 2 \log 2 - 1) = 5c - 6d - 4$. 6. \blacktriangle We have

$$\log_{12} 18 = \frac{\log_2 18}{\log_2 12} = \frac{1+2 \log_2 3}{2+\log_2 3} \quad \text{and}$$

$$\log_{24} 54 = \frac{\log_2 54}{\log_2 24} = \frac{1+3 \log_2 3}{3+\log_2 3},$$

and, therefore, putting $\log_2 3 = x$, we obtain

$$ab + 5(a-b) = \frac{1+2x}{2+x} \frac{1+3x}{3+x} + 5 \left(\frac{1+2x}{2+x} - \frac{1+3x}{3+x} \right)$$

$$= \frac{6x^2 + 5x + 1 + 5(-x^2 + 1)}{(x+2)(x+3)} = \frac{x^2 + 5x + 6}{(x+2)(x+3)} = 1.$$

7. \blacktriangle Setting $\log_2 12 = a$ and taking into account that $1/\log_{36} 2 = = \log_2 2^3 \cdot 12 = a + 3$, $\log_2 24 = 1 + a$, $\log_2 196 = a + 4$ and $1/\log_{12} 2 = a$, we have, for the given expression, $(a+1)(a+3) - a(a+4) = 3$. 8. \blacktriangle Evidently, $(n+1)/n = 1 + 1/n > > (n+2)/(n+1) = 1 + 1/(n+1)$. Using the properties of a logarithmic function, we have (for $n > 1$)

$$\log_n \frac{n+1}{n} > \log_{n+1} \frac{n+1}{n} > \log_{n+1} \frac{n+2}{n+1}, \quad \text{or} \quad \log_n (n+1) -$$

$$- \log_n n > \log_{n+1} (n+2) - \log_{n+1} (n+1), \quad \text{whence we immediately get}$$

$$\log_n (n+1) > \log_{n+1} (n+2), \quad (\log_n n = \log_{n+1} (n+1) = 1).$$

9. \blacktriangle Since $27 > 25$, we have $\log_3 27 > \log_3 25$. But $\log_3 27 = = \log_3 3^3 = \log_3 3^2 = \log_4 9$; consequently, $\log_4 9 > \log_3 25$.

10. (a) $\{5 + \log_3 7\}$; (b) $\{8/7\}$; (c) $\{0\}$; (d) $\{2\} \pm \sqrt{7/2}$; (e) $\{10\}$;
 (f) $\{1\}$; (g) $\{1/\sqrt{3}\}$; (h) $\{5\}$; (i) $\{0\}$; (j) $\{\log_{4.5} (9/\sqrt{8})\}$; (k) $\{-0.2; 3\}$;

(l) {3}; (m) {10}; 11. (a) {-1; 1}. \blacktriangle Setting $2^{x^2+2} = t$, we reduce the original equation to the form $t^2 - 9t + 8 = 0$. Solving this quadratic equation, we get $t_1 = 1$, $t_2 = 8$. Thus, the original equation is equivalent to the collection of the equations $2^{x^2+2} = t_1 = 1$, $2^{x^2+2} = t_2 = 8$. The first equation has no solutions ($x^2 + 2 \neq 0$ for any $x \in \mathbb{R}$), the second exponential equation $2^{x^2+2} = 2^3$ can be reduced to the quadratic equation $x^2 + 2 = 3$, whose solutions are $x_1 = 1$ and $x_2 = -1$;

(b) $\{-\sqrt{2}; -1; 1; \sqrt{2}\}$. \bullet Set $3^{x^2-1} = t$; (c) {20}; (d) $\left\{\frac{3}{2}\right\}$. \bullet Set

$2^{x+\sqrt{x^2-2}} = t$. 12. (a) $\{\log_{3/2} 2; 2 \log_{3/2} 2\}$. \bullet Divide the equation by 4^x and put $(3/2)^x = t$; (b) $\{1 - \sqrt{3}; 0; 2; 1 + \sqrt{3}\}$. \bullet Divide the equation by 9^{2x-x^2+1} and put $(5/3)^{2x-x^2+1} = t$; (c) $\{1 - \sqrt{3}; 1 + \sqrt{3}\}$; (d) $\{\log \sqrt{5\sqrt{2}-7}; 6; 0\}$. 13. (a) {-2; 3}. \blacktriangle Set $3^{x^2} = u$,

$3^{x+6} = v$. The original equation assumes the form $u^2 - 2uv + v^2 = 0$ or $(u-v)^2 = 0$; hence it follows that $3^{x^2} = 3^{x+6}$. Solving the exponential equation, we get the answer; (b) {2; 4}. \bullet Setting $2^{\sqrt{2x+1}} =$

y , $2^x = z$, we obtain $x^2y/2 + z = 2y + x^2z/4$ or $(x^2/4 - 1)(2y - z) = 0$. Hence we have $x^2/4 - 1 = 0 \Rightarrow x_1 = -2$ (extraneous root), $x_2 = 2$ or

$2^{\sqrt{2x+1}+1} = 2^x$, $\sqrt{2x+1} = x-1 \Rightarrow x_3 = 0$ (extraneous root), $x_4 = 4$.

14. (a) {11}. \blacktriangle Let us transform the left-hand side of the equation: $4^{\log_4(x-3)+\log_2 5} = 4^{\log_4 3(x-3)} (2^{\log_2 5})^3 = 5^3 (4^{\log_4(x-3)})^{1/3} = 25 (x-3)^{1/3}$.

Now we have $25(x-3)^{1/3} = 50$, $x-3 = 2^3$, $x = 11$; (b) {4}. 15. {-3; -1}. 16. (a) {27}; (b) {-1}. \blacktriangle We reduce the equation to the form

$$\log_2(3-x)(1-x) = \log_2 2^3, \quad (1)$$

or, after the transformations, to $x^2 - 4x - 5 = 0$. The last equation has the roots $x = -1$ and $x = 5$. Since equation (1) is not equivalent to the original equation, it is necessary to verify the roots obtained.

Verification shows that the root $x = 5$ of the quadratic equation does not satisfy the original equation; (c) {4}; (d) {8}; (e) {2}; (f) {3}; (g) {3; $3 + \sqrt{2}$ }. \bullet Take into consideration that $\log_2(x-4)^2 =$

$2 \log_2 |x-4|$; (h) $\{-11; -6 - \sqrt{7}; -6 + \sqrt{7}; -1\}$; (i) {3}; (j) $\{-17\}$; (k) {1}; (l) {2}; (m) $\{\sqrt{2}; \sqrt{6}\}$. \bullet Use the identity $\log^2 a = \log^2(1/a)$.

17. (a) $\left\{-2^{\frac{1}{\log_a 4a^4}}; 2^{\frac{1}{\log_a 4a^4}}\right\}$ for $a \in (0, 1/\sqrt{2}) \cup (1/\sqrt{2}, 1) \cup (1; \infty)$, \emptyset for the other $a \in \mathbb{R}$; (b) $\{(3a+3)/(7-a)\}$ for $a \in (3; 7)$, \emptyset for $a \notin (3; 7)$; (c) $\{(2a-1)/6\}$ for $a \in (-\infty; -12) \cup (1/2; \infty)$; \emptyset for $a \in [-12; 1/2]$. \blacktriangle The original equation is equivalent to the system

$$\begin{cases} 6x^2 + 25x = 2ax + 8a - 4, \\ 6x^2 + 25x > 0. \end{cases}$$

Solving the equation of the system, we find that $x_1 = -4$ (extraneous root since the inequality of the system is not satisfied), $x_2 = (2a - 1)/6$. Then, solving the inequality $6((2a - 1)/6)^3 + 25((2a - 1)/6) > 0$, we find the permissible values of the parameter. 18. (a) $\{1; 60\}$. \blacktriangle For $x = 1$ both parts of the equation vanish; consequently, $x = 1$ is a root of the equation. Let us now seek the roots of the equation assuming that $x \neq 1$ (both parts of the equation turn into zero only for $x = 1$). For that purpose, we multiply the equation by $1/(\log_3 x \log_4 x \log_5 x)$:

$$1 = 1/\log_5 x + 1/\log_3 x + 1/\log_4 x = \log_x 3 + \log_x 4 + \log_x 5.$$

Solving now the equation $\log_x 3 \cdot 4 \cdot 5 = 1$, we find the other root $x = 60$; (b) $\{1; \sqrt[3]{8}\}$. \bullet Reduce the equation to the form

$$\frac{1}{2} \log_2 x - \log_3 x \cdot \log_3 x - 3 \log_3 x = 0 \quad (1)$$

and verify that $x = 1$ is a root of that equation; then reduce equation (1) to the form $\log_x 3 - 6 \log_x 2 - 2 = 0$ and find other roots.

19. (a) $\{1/10; \sqrt{10}\}$; (b) $\{1/2; 4\}$; (c) $\{3; 3^9\}$; (d) $\{1/625; 5\}$; (e) $\{\sqrt[5]{3}; 5\}$.

\bullet Set $\log_x \sqrt{5} = t$; (f) $\{10\}$; (g) $\{-1/4\}$. \bullet Set $\log_{2x+7} (2x+3) = t$; (h) $\{0; 7/4; (3 + \sqrt{24})/2\}$. \bullet Set $\log(4-x) = u$, $\log(x+1/2) = v$ and factor the polynomial $u^2 + uv - 2v^2$.

20. (a) $\{2\}$; \bullet $\log_x 27 \cdot \log_9 x = \log_x 27 / \log_x 9 = \log_9 27 = 3/2$; (b) $\{1/\sqrt[3]{4}; 8\}$.

\bullet Set $\log_2 x = t$; (c) $\{1/\sqrt{2}; 1; 4\}$. \blacktriangle Using the formula $\log_N M = \frac{\log_a M}{\log_a N}$, we transform the left-hand side of the equation:

$$\begin{aligned} & \frac{\log_2 x^3}{\log_2 \frac{x}{2}} - 14 \frac{\log_2 x^3}{\log_2 16x} + 40 \frac{\log_2 \sqrt{x}}{\log_2 4x} \\ &= \frac{2 \log_2 x}{\log_2 x - 1} - \frac{42 \log_2 x}{\log_2 x + 4} + \frac{20 \log_2 x}{\log_2 x + 2}. \end{aligned}$$

Assuming now that $\log_2 x = t$, we reduce the equation to the form $t(2t^2 - 3t - 2) = 0$, whose roots are $t_1 = 0$, $t_2 = -1/2$ and $t_3 = 2$. Then, solving the equations $\log_2 x = t_n$ ($n = 1, 2, 3$) and verifying these roots by means of direct substitution into the original equation, we get the answer; (d) $\{1/8; 1; 4\}$; (e) $\{1/9; 1; 3\}$; (f) $\{5\}$.

21. (a) $\{a - 1; a + 1\}$ for $a \in (1; \sqrt{2}) \cup (\sqrt{2}; 2) \cup (2; \infty)$, $\{3\}$ for $a = 2$; (b) $\{a^2\}$ for $a \in (0, 1/\sqrt{2}) \cup (1/\sqrt{2}; 1) \cup (1; \infty)$. 22. (a) $\{25\}$.

\bullet Put $3 + \log_{0.3} x = t$; (b) $\{1/9\}$; (c) $\{\sqrt{(1 + \sqrt{5})/2}\}$. \bullet Put $\log_x (x^2 + 1) = t$; (d) $\{2\}$. \bullet Put $\sqrt{\log_3 x} = t$. 23. (a) $\{3\}$; (b) $\{1/3\}$; (c) $\{3; 10\}$. 24. (a) $\{2; 4\}$; (b) $\{\log_3 (3/5); \log_3 (2/5)\}$. 25. (a) $\{2\}$; (b) $\{2\}$; (c) $\{0\}$; (d) $\{-1, 2\}$; (e) $\{2\}$; (f) $\{-\log_3 3\}$. 26. (a) $\{-9/10; 99\}$; (b) $\{1/10^9; 10^9\}$; (c) $\{1000\}$; (d) $\{0\}$. 27. $\{1/10; 2; 1000\}$. 28. $\{0.2; 6\}$.

29. {2}. ● Put $2^{\log_2(3x-2)} = u$, $3^{\log_2(3x-2)} = v$ and solve the equation $3u^2 - 5uv + 2v^2 = 0$ with respect to u (or v). 30. 15 for $a \in \{3\}$. 31. $[1/5; \infty)$. 32. $\{1/16\} \cup [4; \infty)$. ▲ If we set $\sqrt{x} - |\sqrt{x} - 2| = y$, then we can reduce the original equation to the form $\log_2 \sqrt{y+6} = \log_2 \sqrt{2|y|}$ or $2y^2 - y - 6 = 0$, whose roots are $y_1 = 2$ and $y_2 = -3/2$. Taking this into account, we have:

(1) $\sqrt{x} - |\sqrt{x} - 2| = y_1 = 2 \Rightarrow \sqrt{x} - 2 = |\sqrt{x} - 2| \Rightarrow \Rightarrow x \geq 4$; (2) $\sqrt{x} - |\sqrt{x} - 2| = y_2 = -3/2 \Rightarrow 2\sqrt{x} = 1/2 \Rightarrow x = 1/16$. Uniting the solutions obtained, we find the answer.

33. (a) {2}. ▲ We establish by means of selection that $x = 2$ is a root of the equation. Let us prove that the original equation has no other roots. We reduce the equation to the form $(5/13)^x + (12/13)^x = 1$ and assume that it has a solution: $x < 2$. We consider two exponential functions: $y_1 = (5/13)^x$ and $y_2 = (12/13)^x$. They are decreasing, and, therefore, for the values $x < 2$ we have $(5/13)^x > (5/13)^2$ and $(12/13)^x > (12/13)^2$. Adding these inequalities together, we get $(5/13)^x + (12/13)^x > (5/13)^2 + (12/13)^2 = 1$, and this means that the given equation does not have roots smaller than 2. We can prove by analogy that the equation does not have roots exceeding 2; (b) {3}; (c) {0}. ● To prove the uniqueness of the solution, investigate the behaviour of the functions $y = 2^x$ and $y = 1 - x$ on the intervals $(-\infty; 0)$ and $(0; \infty)$; (d) {3}. 34. (a) {(2; 3/2)}; (b) $\{|a|^{66/5}; |a|^{72/5}\}$, for $a \neq 0, |a| \neq 1$; (c) {(1/2; 1/2)}. 35. (a) {(9/2, 1/2)}; (b) {8; 1}. 36. (a) {(3/2; 1/2)}. ● Take logarithms of the second equation of the

system to the base 2; (b) $\{(\sqrt[4]{3}; -1); (\sqrt[4]{3}; 1)\}$. 37. (a) {(18; 2); (2; 18)}; (b) {(20; 5)}; (c) {(3; 6); (6; 3)}; (d) {(4; -1/2)}. ● Set $\log_2 x = u$, $4^{-y} = v$; (d) {(0.1; 2); (100; -1)}. ● Take logarithms of the second equation of the system to the base 10; (f) {(2; 10); (10; 2)}; (g) {(2; 1/6)}; (h) $\{(9a/2; a/2); (a/2; 9a/2)\}$ for $a \in (0; 1) \cup (1; \infty)$. 38. (a) {(2; 4); (4; 2)}. ● In the first equation of the system set $\log_x y = z$; (b) $\{a^2; a\}; (a; a^2)\}$ for $a \in (0; 1) \cup (1; \infty)$, $\{(a+1)^2; -(a+1)\}; (-(a+1); (a+1)^2)\}$ for $a \in (-\infty; -2) \cup (-2; -1)$, \emptyset for $a \in \{-2; 1\} \cup [-1; 0]$. 39. {(3; 9); (9; 3)}. 40. {(3; 2)}. 41. $\{(-2; -2); (2; 2)\}$. 42. {(12; 4)}. 43. {(5; 1/2)}. 44. {(64; 1/4)}. 45. $\{(-2; 4)\}$. ● When solving the system, take into account that $y \in \mathbb{N}$. 46. (a) $[-1; 1 - \sqrt{3}] \cup (1 + \sqrt{3}; 3]$. ▲ The original inequality is equivalent to the system of inequalities

$$\begin{cases} x^2 - 2x - 2 > 0, \\ x^2 - 2x - 2 \leq 1. \end{cases}$$

The solution of the first inequality is $x \in [-\infty; 1 - \sqrt{3}] \cup (1 + \sqrt{3}; \infty)$, and of the second, $x \in [-1; 3]$. The intersection of these sets of solutions is the set of values $x \in [-1; 1 - \sqrt{3}] \cup (1 + \sqrt{3}; 3]$; (b) $\nabla(2; 9)$; (c) $[-4; -3] \cup (0; 1]$; (d) (4; 6); (e) $(-\infty; -2) \cup (-1/2; \infty)$; (f) $[-2; -2/3]$; (g) $[0; 2 - \sqrt{2}] \cup (2 + \sqrt{2}; 6]$; (h) (3/4; 4/3). 47. (a) $(-\infty; -2.5) \cup (0; \infty)$;

(b) $(-1 - \sqrt{2}; -2) \cup (0; \sqrt{2} - 1)$; (c) $(-\infty; 2 - \sqrt{2}) \cup (2 + \sqrt{2}; \infty)$; (d) $(-\infty; -2) \cup (5/8; \infty)$; (e) $[-7; -\sqrt{35}) \cup [5; \sqrt{35})$. 48. (a) (2; 7). \blacktriangle Since one and the same number, exceeding unity, serves as the base of the logarithms of the left-hand and right-hand sides of the inequality, the original inequality is equivalent to the system

$$\begin{cases} 2x-4 > 0, \\ x+3 > 2x-4, \end{cases}$$

solving which, we get the answer; (b) $(-\sqrt{5}; -2) \cup (1; \sqrt{5})$. \bullet The original inequality is equivalent to the system

$$\begin{cases} x^2+x-2 > 0, \\ x^2+x-2 < x+3, \end{cases}$$

(l) $(-1; 1) \cup (3; \infty)$; (d) $[(1 - \sqrt{5})/2; (1 + \sqrt{5})/2]$. \bullet Reduce the left-hand side of the inequality to the form $\log_2(x+1)^{-1}$; (e) $(-1; 1 + 2\sqrt{2})$. 49. (a) (2; 7) \cup (22; 27). \blacktriangle The original inequality is equivalent to the system

$$\begin{cases} x-2 > 0, \\ 27-x > 0, \\ \log(x-2)(27-x) < 2, \end{cases}$$

which in turn, is equivalent to the system of inequalities

$$\begin{cases} 2 < x < 27, \\ 0 < (x-2)(27-x) < 100, \end{cases}$$

solving which, we get the answer; (b) (2; 4); (c) (1; 11/10); (d) $[-1; 4)$; (e) $(-4; -1 - \sqrt{3}) \cup (0; \sqrt{3} - 1)$; (f) (3; 5); (g) (2; 5); (h) $(-\infty; -1) \cup (2; \infty)$. 50. $(\log_2 5; \infty)$; (b) $(-1; 7)$; (c) $(1 - \sqrt{5}; -1) \cup (3; 1 + \sqrt{5})$; (d) $(-\infty; 0) \cup (3; \infty)$; (e) (2; ∞); (f) $(-\infty; -8) \cup (4; \infty)$; (g) $[0; \infty)$ for $a \in (-\infty; 0)$, $((a \log_2 2)^2; \infty)$ for $a \in [0; \infty)$. 51. (a) $(0; 10^{-4}) \cup [10; \infty)$. \blacktriangle Setting $\log x = t$, we get an inequality $t^2 + 3t - 4 \geq 0$, which is equivalent to the collection of inequalities

$$\begin{cases} t \leq -4 \\ t \geq 1, \end{cases} \quad \text{or} \quad \begin{cases} \log x \leq -4, \\ \log x \geq 1, \end{cases}$$

solving which, we get the answer; (b) $(0; 1/2) \cup [\sqrt{2}; \infty)$. \bullet Set $\log_2 x = t$; (c) $(0; 1) \cup (\sqrt{3}; 9)$; (d) $(1/16; 1/8) \cup (8; 16)$. \bullet Set $\log_2^2 x = t$; (e) $(0; 1/\sqrt{27}) \cup [1/3; \sqrt{243}] \cup [27; \infty)$. \bullet Set $2 \log_2^2 x - 3 \log_2 x - 7 = t$; (f) $(1/16; 1/4) \cup (1/2; 2)$; (g) $(0; 1/2) \cup (32; \infty)$. 52. (a) $\left[\log_2 \frac{\sqrt{3}}{2}; \infty \right)$. \bullet Set $2^{2x+1} = t > 0$;

(b) $(-1; \infty)$. \bullet Set $10^x = t > 0$; (c) $(\log_2(3 - \sqrt{5})/2;$

$\log_2(3 + \sqrt{5})/2$; (d) $(-\infty; 1 - \log_3 \sqrt[3]{5}]$. ● Set $3^{2-3x} = t > 0$;
 (e) $(-\infty; 0) \cup (\log_2 3; \infty)$; (f) $(0.01; \infty)$. ● Set $3^{\log x + 2} = t > 0$;
 (g) $(-\infty; -1) \cup (-0.1; 0)$. ● Set $2^{\log(-x)} = t > 0$.
 53. (a) $(\log_2(5 + \sqrt{33}) - 1; \infty)$; (b) $(-\infty, 0] \cup [\log_6 5; 1)$;
 (c) $(\log_5(\sqrt{2} + 1); \log_5 3)$. ● Set $\log_{\sqrt{2}}(5^x - 1) = t$; (d) $(-\infty; 0) \cup$
 $\cup (0; \infty)$. 54. (a) $[2; +\infty)$; (b) $[28/3; \infty)$; (c) $[\log_3(83/19); \infty)$.
 55. (a) $(-3; -\sqrt{6}) \cup (\sqrt{6}; 3)$; (b) $(-1/2; 2)$. 56. (a) $[-3; 1)$;
 (b) $(-4; (1 + \sqrt{17})/2)$. 57. (a) $(0; 2) \cup (4; \infty)$; (b) $(1000; \infty)$;
 (c) $(0; 1/4] \cup [4; \infty)$. 58. (a) $((1 + \sqrt{1 + 4a^2})/2; \infty)$ for $a \in (1; \infty)$;
 $(1; (1 + \sqrt{1 + 4a^2})/2)$ for $a \in (0; 1)$. ▲ It is necessary to consider the
 cases $a > 1$ and $0 < a < 1$. If $a > 1$, then the original inequality is
 equivalent to the system

$$\begin{cases} x > 1, \\ x(x-1) > a^2. \end{cases}$$

The roots of the quadratic trinomial $x^2 - x - a^2$ are $x_1 =$
 $= (1 - \sqrt{1 + 4a^2})/2$ and $x_2 = (1 + \sqrt{1 + 4a^2})/2$, and the solutions
 of the second inequality of the system are $x \in (-\infty; x_1) \cup (x_2; \infty)$.
 But $x_1 < 0$ and, therefore, the solution of the system is the interval
 $(x_2; \infty)$ ($x_2 > 1$ for $a > 1$). We can, by analogy, consider the case
 when $0 < a < 1$. We have a system

$$\begin{cases} x > 1, \\ x^2 - x - a^2 < 0. \end{cases}$$

The solutions of the second inequality of the system are $x \in (x_1; x_2)$.
 With the first inequality of the system taken into account, we get
 $x \in (1; x_2)$; (b) $(0; a^2) \cup (a^2; a^2) \cup (1/a; \infty)$; (c) $(1/a; a^4)$ for $a \in (1; \infty)$;
 $(a^4; 1/a)$ for $a \in (0; 1)$; (d) $[\log_a(4 + \sqrt{16 + a^2}); 3 \log_a 2)$ for $a \in$
 $\in (0; 1)$, $\log_a(4 + \sqrt{16 + a^2}); \infty)$ for $a \in (1; \infty)$. 59. (a) $(3; 4) \cup$
 $\cup (5; \infty)$. ▲ The original inequality is equivalent to the collection
 of the systems

$$\begin{cases} x-3 > 1, \\ 0 < x-1 < (x-3)^2; \end{cases} \quad \begin{cases} 0 < x-3 < 1, \\ x-1 > (x-3)^2 > 0. \end{cases}$$

The right-hand system has solutions $x \in (5; \infty)$, and the second system,
 $x \in (3; 4)$; uniting these solutions, we get the answer; (b) $(1; 2)$.
 60. (a) $(0; 1/2) \cup (1; 2) \cup (3; 6)$; (b) $(-3; -2) \cup (-1; 0) \cup (1; 3)$;
 (c) $(-4/3; -23/22)$; (d) $(-2; -3/2) \cup [-1; 3]$; (e) $(1/5; 1/2)$.
 61. (a) $(-3; -1)$; (b) $(0; (\sqrt{13} - 3)/2) \cup (1; \infty)$. 62. $[-1; 1/2) \cup$

$\cup [1; 2) \cup (2; 7/2)$. 63. $(3; 5 - \sqrt{3}) \cup (7; \infty)$. 64. (a) $(1; 2)$; (b) $(0; 3) \cup (4; 6) \cup (6; 12) \cup (14; \infty)$. 65. (a) $(0; 4)$; (b) $[2, 4)$; (c) $(1/2, 4)$; (d) $(1; 2)$. 66. (a) $(0; 2)$. ● Reduce the inequality to the form $(2^x - 1)(25 - 5^x) > 0$; (b) $(1/\sqrt{5}; 1) \cup (3; \infty)$. ● Reduce the inequality to the form $(\log_3 x - 1)(2 \log_3 x + 1)/\log_3 x > 0$; (c) $(-1; \infty)$.

67. {8}. ● Prove that $\log_{0.3} \left(\frac{10}{7} (\log_3 5 - 1) \right) < 0$; (b) {4}. 68. $(0; 1/a^4)$

for $a \in (1; \infty)$, $(0; a^8)$ for $a \in (0; 1)$. 69. The functions given in (a), (b), (f) are even, those given in (c), (d), (e), (g), (h) are odd.

70. $3^x = (3^x + 3^{-x})/2 + (3^x - 3^{-x})/2$. ▲ Suppose $f_1(x) = f_1(-x)$ and $f_2(x) = -f_2(-x)$. Then $3^x = f_1(x) + f_2(x)$ (1), and $3^{-x} = f_1(-x) + f_2(-x) = f_1(x) - f_2(x)$ (2). Solving the system of equations (1)

and (2) for $f_1(x)$ and $f_2(x)$, we get $f_1 = \frac{3^x + 3^{-x}}{2}$ and $f_2(x) = \frac{3^x - 3^{-x}}{2}$.

71. $T = 2\pi$; no, it is not. 72. $y = \ln(x + \sqrt{1 + x^2})$.

73.

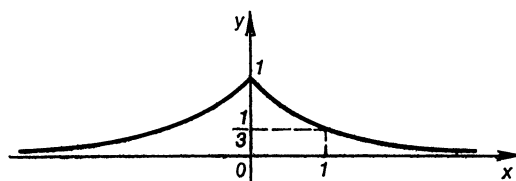

74.

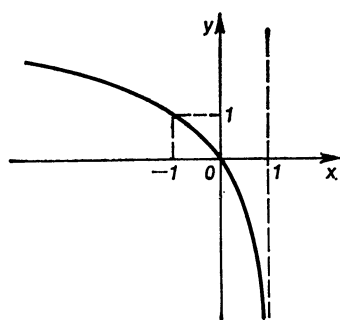

75.

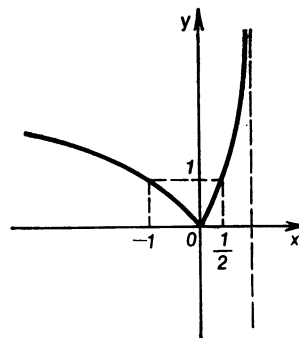

76.

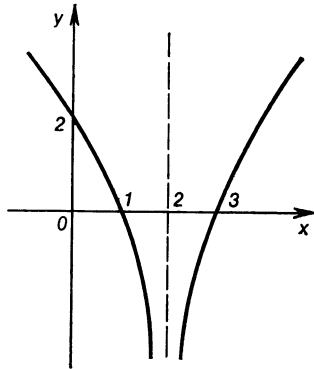

77.

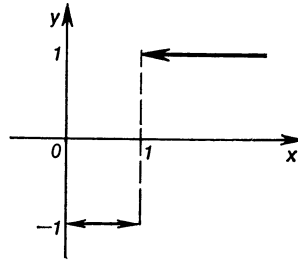

78.

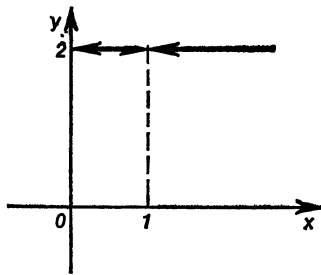

79.

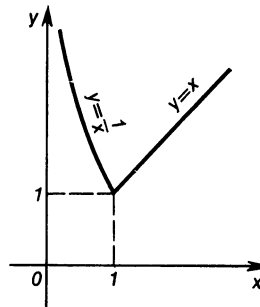

80.

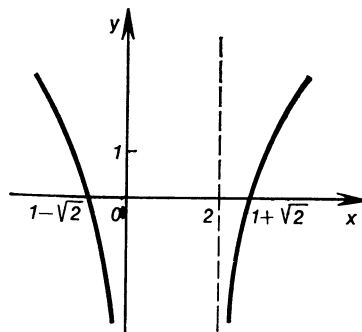

81.

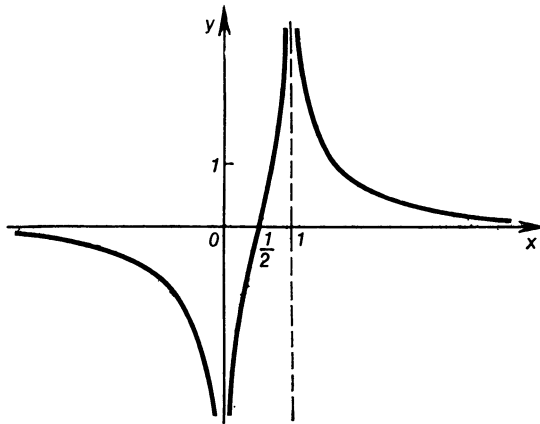

82.

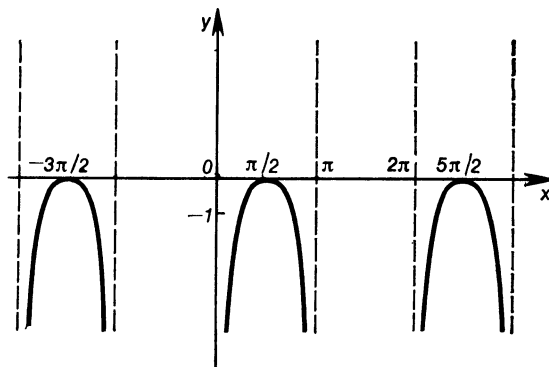

83.

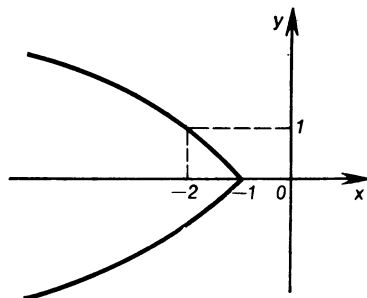

84. (a) $3^x \ln 3$; (b) $10^x \ln 10$; (c) $\frac{1}{2^x} \ln \frac{1}{2}$; (d) $e^x - e^{-x}$; (e) $2e^x + e^{-x}$;
 (f) $3^x \ln 3 + 4^x \ln 4$; (g) $10^x (1 + x \ln 10)$; (h) $e^x (1 + x)$; (i) $e^{-x} (1 - x)$;
 (j) $\sqrt{2^x} \ln \sqrt{2}$; (k) $e^{x^2 - 5x^2} (3x^2 - 10x)$; (b) $x e^{x^2} / (1 + x)^2$. 85. (a) $1/(x \ln 3)$; (b) $(1/x) (1/\ln 2 - 1/\ln 3)$; (c) $1/(2x \ln 5)$; (d) $5/(x \ln 7)$;
 (e) $1 + 1/x$; (f) $\ln x + 1$; (g) $(2 \ln x)/x$; (h) $1/(2x \sqrt{\ln x})$; (i) $-2/(x(1 + \ln x)^2)$; (j) $(1 + x^2 - 2x^2 \ln x)/(x(1 + x^2)^2)$. 86. (a) $32 \ln 2$; (b) $-1/3$; (c) 1.2 ; (d) 3 . 87. (a) $y = x + 1$; (b) $y = x - 1$. 88. (a) $\{0\}$; (b) $\{-1; 3\}$; (c) $\{-2; -1\}$; (d) $\{-1/2; 1\}$;
 (e) $\{-\ln a\}$ for $a \in (0; \infty)$, for $a \in (-\infty; 0]$ the function has no critical points. \blacktriangle Differentiating the derivative and equating it to zero, we get an equation $e^{-2x} - (a - 3)e^{-x} - 3a = 0$, whence we have $e^{-x} = -3$ and $e^{-x} = a$. The first equation has no real solutions, and the second has $x = -\ln a$ if $a > 0$. For $a \leq 0$, the second equation has no real roots either; (f) $\{\log_{0.2}(-a)\}$ for $a \in (-\infty; 0)$; for $a \in [0; \infty)$ the function has no critical points; (g) $\{0; \ln 2\}$. 89. (a) $\{2\}$; (b) $\{e^3\}$;
 (c) $\{-4; 1\}$. 90. $(2/3; 4/3)$ and $(2; \infty)$. 91. $(3 - \sqrt{1 + 1/(3e)}; 2)$ and $(4; 3 + \sqrt{1 + 1/(3e)})$. 92. (a) Increases on $(-\infty; 0)$; decreases on $(0; \infty)$; (b) increases on $(e; \infty)$, decreases on $(0; 1)$ and $(1; e)$; (c) increases on $(\log_2(3/2); \infty)$, decreases on $(-\infty; \log_2(3/2))$. 93. (a) $x = 1$ is a point of maximum; $x = e$ is a point of minimum; (b) the function has no points of extremum. 94. $\{-2/3; -1/6\}$. $\blacktriangle f'(x) = \frac{a}{x} + 2bx + 1$, $f'(1) = f'(2) = 0$; consequently, we have a system

$$\begin{cases} a + 2b = -1, \\ a/2 + 4b = -1. \end{cases}$$

Solving it for a and b , we find that $a = -2/3$, $b = -1/6$. Thus, we have $f'(x) = -2/(3x) - x/3 + 1$, and make sure by verification that at the points $x = 1$ and $x = 2$ the derivative changes sign.

95. (a) $\max_{[-4; 4]} y = y(-4) = 7e^4$, $\min_{[-4; 4]} y = y(-2) = -3e^2$;

(b) $\max_{[-1; 2]} y = y(2) = 17/(4 \ln 2)$, $\min_{[-1; 2]} y = y(0) = 2/(\ln 2)$,

(c) $\max_{[-1; 1]} y = y(1) = 24$, $\min_{[-1; 1]} y = y(0) = 0$;

(d) $\max_{[1/2; 4]} y = y(4) = 21 + 3 \ln 2$, $\min_{[1/2; 4]} y = y(1) = 0$.

96. 0. 97. (a) $(3.5; \infty)$; (b) $(-\ln 2; \ln 2)$. 98. (a) \blacktriangle Let us consider the function $f(x) = e^x - x - 1$. We have $f'(x) = e^x - 1 > 0$ for $x \in (0; \infty)$, $f(0) = 0$, consequently, $f(x) > 0$ for all x belonging to the indicated interval. (b) \bullet Investigate the sign of the derivative of the function $F(x) = x - \ln(1 + x)$ on the given interval.

99.

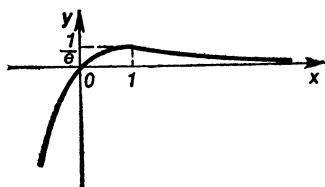

100.

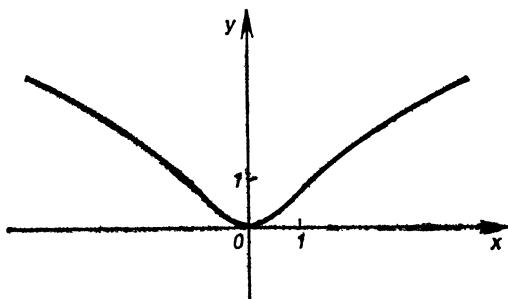

2.4. Transformation of Trigonometric Expressions

2. (a) $\sqrt{2-a^2}$; (b) $1-(a^2-1)^2/2$. ● $\sin^4 \alpha + \cos^4 \alpha = (\sin^2 \alpha + \cos^2 \alpha)^2 - 2(\sin \alpha \cos \alpha)^2 = 1 - 2((a^2-1)/2)^2$. 3. (a) p^2-2 ; (b) p^2-3p . 4. (a) $(4\sqrt{3}+3)/10$; (b) $(\sqrt{3}(1-b^2)-b)/2$. ▲ Setting $40^\circ + \alpha = \beta$, we get $\cos(70^\circ + \alpha) = \cos(30^\circ + \beta) = (\sqrt{3}/2)\cos \beta - (1/2)\sin \beta$. Since $0^\circ < \alpha < 45^\circ$, we have $\cos \beta > 0$ and, therefore, $\cos \beta = \sqrt{1-b^2}$. The final result is $\cos(30^\circ + \beta) = \sqrt{3}(1-b^2)/2 - b/2$; (c) $1073/1105$. ● $\sin(\alpha + \beta - \gamma) = \sin(\alpha + \beta)\cos \gamma - \cos(\alpha + \beta)\sin \gamma = \sin \alpha \cos \beta \cos \gamma + \cos \alpha \sin \beta \cos \gamma - \cos \alpha \cos \beta \sin \gamma + \sin \alpha \sin \beta \sin \gamma$; (d) $-117/125$; $44/125$; $-117/44$. ● $\sin 3\alpha = 3 \sin \alpha \cos^2 \alpha - \sin^3 \alpha = 3 \sin \alpha - 4 \sin^3 \alpha$, $\cos 3\alpha = 3 \cos^3 \alpha - 3 \sin^2 \alpha \cos \alpha = 4 \cos^3 \alpha - 3 \cos \alpha$
 $\tan 3\alpha = \frac{\sin 3\alpha}{\cos 3\alpha} = \frac{3 \sin \alpha \cos^2 \alpha - \sin^3 \alpha}{\cos^3 \alpha - 3 \sin^2 \alpha \cos \alpha} = \frac{3 \tan \alpha - \tan^3 \alpha}{1 - 3 \tan^2 \alpha}$. 5. ● Use the equality $\alpha + \beta = \pi - \gamma$. 7. (a) $\tan 2\alpha$; (b) $-\tan \alpha$; (c) $\tan 2\alpha$;

(d) $\operatorname{cosec} \alpha$; (e) $-1/2$. ▲ $\cos \frac{2\pi}{7} + \cos \frac{4\pi}{7} + \cos \frac{6\pi}{7} = \frac{2 \sin \frac{\pi}{7}}{2 \sin \frac{\pi}{7}} \times$

$$\begin{aligned} & \times \left(\cos \frac{2\pi}{7} + \cos \frac{4\pi}{7} + \cos \frac{6\pi}{7} \right) = \\ & = \frac{\left(\sin \frac{3\pi}{7} - \sin \frac{\pi}{7} \right) + \left(\sin \frac{5\pi}{7} - \sin \frac{3\pi}{7} \right) + \left(\sin \pi - \sin \frac{5\pi}{7} \right)}{2 \sin \frac{\pi}{7}} = \end{aligned}$$

$$= \frac{-\sin \frac{\pi}{7}}{2 \sin \frac{\pi}{7}} = -\frac{1}{2}; \text{ (f) 1. } \bullet \text{ Reduce the expression to the form}$$

$$\frac{\sin \frac{13}{14} \pi - \sin \left(-\frac{\pi}{14} \right)}{2 \sin \frac{\pi}{14}}. \text{ 8. (g) } \blacktriangle \text{ We have } 16 \sin 10^\circ \sin 30^\circ \sin 50^\circ \times$$

$$\begin{aligned} & \times \sin 60^\circ = 16 \cos 80^\circ \cos 60^\circ \cos 40^\circ \cos 20^\circ = 8 \cos 80^\circ \cos 60^\circ \cos 40^\circ \times \\ & \times \frac{2 \cos 20^\circ \sin 20^\circ}{\sin 20^\circ} = 4 \cos 80^\circ \cos 60^\circ \frac{2 \sin 40^\circ \cos 40^\circ}{\sin 20^\circ} = 2 \cos 60^\circ \times \\ & \times \frac{2 \sin 80^\circ \cos 80^\circ}{\sin 20^\circ} = 2 \cdot \frac{1}{2} \cdot \frac{\sin 160^\circ}{\sin 20^\circ} = \frac{\sin (180^\circ - 160^\circ)}{\sin 20^\circ} = 1; \text{ (h) } \bullet \text{ Use} \end{aligned}$$

the formulas $2 \cos^2 \alpha = 1 + \cos 2\alpha$, $2 \sin^2 \alpha = 1 - \cos 2\alpha$; (k) \bullet $1 \pm \sin \alpha = (\sin(\alpha/2) \pm \cos(\alpha/2))^2$. 9. $1/3$. \blacktriangle $\sin \alpha + \cos \alpha = \frac{2 \tan(\alpha/2)}{1 + \tan^2(\alpha/2)} + \frac{1 - \tan^2(\alpha/2)}{1 + \tan^2(\alpha/2)} = 1.4$; Hence we get $2.4 \tan^2(\alpha/2) - 2 \tan(\alpha/2) + 0.4 = 0$, $\tan(\alpha/2) = 1/3$ and $\tan(\alpha/2) = 1/2$. The value $\tan(\alpha/2) = 1/2$ does not fulfill the condition $0 < \alpha/2 < \pi/8$ ($\tan(\pi/8) = \sqrt{2} - 1 < 1/2$). 10. π . \blacktriangle It follows from the hypothesis that $0 < \alpha + \beta + \gamma < 3\pi/2$, $0 < \frac{\beta + \gamma}{2} < \frac{\pi}{2}$, $\tan \frac{\beta}{2} \tan \frac{\gamma}{2} < 1$ (α, β, γ being positive acute angles) and, therefore, we can make the following transformations:

$$\begin{aligned} \tan \frac{\beta + \gamma}{2} &= \frac{\tan \frac{\beta}{2} + \tan \frac{\gamma}{2}}{1 - \tan \frac{\beta}{2} \tan \frac{\gamma}{2}} = \frac{\frac{1}{3} \cot \frac{\alpha}{2} + \frac{2}{3 \tan \frac{\alpha}{2} + \cot \frac{\alpha}{2}}}{1 - \frac{1}{3} \cot \frac{\alpha}{2} \frac{2}{3 \tan \frac{\alpha}{2} + \cot \frac{\alpha}{2}}} = \\ &= \cot \frac{\alpha}{2}, \end{aligned}$$

i.e. $\tan \frac{\beta + \gamma}{2} - \cot \frac{\alpha}{2} = 0$, whence it follows that

$$\sin \left(\frac{\beta + \gamma}{2} \right) \sin \frac{\alpha}{2} - \cos \frac{\alpha}{2} \cos \left(\frac{\beta + \gamma}{2} \right) = -\cos \frac{\alpha + \beta + \gamma}{2} = 0,$$

which is only possible for $\frac{\alpha+\beta+\gamma}{2} = \frac{\pi}{2}$ (it is clear from the hypothesis that $0 < \frac{\alpha+\beta+\gamma}{2} < \frac{3\pi}{4}$, i.e. $\alpha+\beta+\gamma = \pi$).

11. (a) $(\sqrt{2-\sqrt{2}})/2$. $\bullet \cos 292^\circ 30' = \sin 22^\circ 30' = \sqrt{(1-\cos 45^\circ)/2}$;

(b) 4. $\blacktriangle \operatorname{cosec} 10^\circ - \sqrt{3} \sec 10^\circ = \frac{2\left(\frac{1}{2} \cos 10^\circ - \frac{\sqrt{3}}{2} \sin 10^\circ\right)}{\sin 10^\circ \cos 10^\circ} =$

$= \frac{4 \sin (30^\circ - 10^\circ)}{\sin 20^\circ} = 4$; (c) $\sqrt{3}$. $\blacktriangle \frac{2 \cos 40^\circ - \cos 20^\circ}{\sin 20^\circ} =$

$= \frac{\cos 40^\circ - 2 \sin 30^\circ \sin 10^\circ}{\sin 20^\circ} = \frac{\sin 50^\circ - \sin 10^\circ}{\sin 20^\circ} = \frac{2 \cos 30^\circ \sin 20^\circ}{\sin 20^\circ} = \sqrt{3}$;

(d) 4. $\blacktriangle -2\sqrt{2}(2 \sin 35^\circ \sin 10^\circ - \sin 5^\circ - 2 \cos 5^\circ \cos 40^\circ) =$
 $= -2\sqrt{2}(\cos 25^\circ - \sin 5^\circ - \cos 35^\circ - 2 \cos 45^\circ) = -2\sqrt{2}(2 \sin 30^\circ \times$
 $\times \sin 5^\circ - \sin 5^\circ - \sqrt{2}) = 4$; (e) $3/4$. $\blacktriangle \cos^2 73^\circ + \cos^2 47^\circ +$
 $+ \cos 73^\circ \cos 47^\circ = 0.5(1 + \cos 146^\circ + 1 + (\cos 94^\circ + \cos 26^\circ) + \cos 120^\circ) =$
 $= 0.5(3/2 + 2 \cos 60^\circ \cos 34^\circ - \cos(180^\circ - 146^\circ)) = 1/2 \cdot 3/2 = 3/4$;

(f) $-1/2$. $\blacktriangle (\sin 6^\circ - \sin 66^\circ) + (\sin 78^\circ - \sin 42^\circ) = 2 \cos 60^\circ \sin 18^\circ -$
 $-2 \sin 30^\circ \cos 36^\circ = \sin 18^\circ - \sin 54^\circ = \frac{-2 \cos 36^\circ \sin 18^\circ}{\cos 18^\circ} \cos 18^\circ =$

$= -\frac{2 \cos 36^\circ \sin 36^\circ}{2 \cos 18^\circ} = -\frac{\sin 72^\circ}{2 \cos 18^\circ} = -\frac{1}{2}$; (g) $-1/\sqrt{2}$; (h) 4;

(i) 0. $\bullet \tan^2 20^\circ = (1 - \cos 40^\circ)/(1 + \cos 40^\circ)$; (j) $1/5$.

$\blacktriangle (\cot^2 36^\circ \cot^2 72^\circ - 1) + 1 = 1 + \frac{\cos 108^\circ \cos 36^\circ}{\sin^2 36^\circ \sin^2 72^\circ} = 1 - (\cot 36^\circ \times$

$\times \cot 72^\circ)^2 \frac{1}{\cos 36^\circ \cos 72^\circ} = 1 - \cot^2 36^\circ \cot^2 72^\circ \frac{2 \cdot 2 \sin 36^\circ}{\sin 144^\circ} = 1 -$

$-4 \cot^2 36^\circ \cot^2 72^\circ$. We have an equality $[\cot^2 36^\circ \cot^2 72^\circ =$
 $= 1 - 4 \cot^2 36^\circ \cot^2 72^\circ$ or $5 \cot^2 36^\circ \cot^2 72^\circ = 1$, whence we get the

answer. 12. (a) $x^2/9 + y^2/16 = 1$; (b) $y = 4 - x^2$; (c) $y - x = 1$;
 (d) $x^2 + y^2 = 2$.

2.5. Trigonometric Functions

1. (a) $D(y) = \bigcup_{n \in \mathbb{Z}} (-\pi/4 + \pi n/2; \pi/4 + \pi n/2)$; (b) $D(y) = \bigcup_{n \in \mathbb{Z}} (3\pi n;$

$3\pi(n+1))$; (c) $D(y) = \bigcup_{n \in \mathbb{Z}} (\pi n - \pi/2; \pi n + \pi/2)$; (d) $D(y) =$

$= \bigcup_{n \in \mathbb{Z}} (\pi n; \pi(n+1))$. 2. (a) $E(y) = [-1; 3]$; (b) $E(y) = [-2; 8]$;

(c) $E(y) = (-4; 4)$; (d) $E(y) = [-3; 3]$; (e) $E(y) = [-1; 1]$;

(f) $E(y) = [0; \infty)$; (g) $E(y) = [-1; 1]$; (h) $E(y) = [\cos 1; 1]$;

(i) $E(y) = [\cos 2; 1]$; (j) $E(y) = [-1; 1]$; (k) $E(y) = [-\sqrt{2}; \sqrt{2}]$;

(l) $E(y) = [-12; 14]$.

3. (a) $\max_{x \in \mathbb{R}} y = \sqrt{a^2 + b^2} + c$; $\min_{x \in \mathbb{R}} y = c - \sqrt{a^2 + b^2}$. \blacktriangle We transform

the given function as follows: $c + a \cos x + b \sin^2 x = \sqrt{a^2 + b^2} \times$
 $\times \left(\frac{a}{\sqrt{a^2 + b^2}} \cos x + \frac{b}{\sqrt{a^2 + b^2}} \sin^2 x \right) + c = \sqrt{a^2 + b^2} \sin(x + \varphi) + c.$

It is evident that the function y assumes the least value if $\sin(\varphi + x) = -1$, and the greatest value if $\sin(x + \varphi) = 1$; (b) $\max_{x \in \mathbb{R}} y = 11$,

$\min_{x \in \mathbb{R}} y = 1.$ ● $y = 5(1 + \cos 2x) - 3 \sin 2x + (1 - \cos 2x) =$
 $= 4 \cos 2x - 3 \sin 2x + 6.$ 4. $[2\sqrt{2}; \infty).$ 5. $\min_{x \in \mathbb{R}} y = 1.$ ● Reduce

the function to the form $y = (\sin 3x + \sin 2x)^2 + 1.$ 6. ● Prove that the product of an even and an odd function ($\sin x \cos 2x$) is an odd function, and then prove that the sum of three odd functions is an odd function. 7. ● Prove that the product of two odd functions ($\sin^3(x/2) \sin x$) is an even function; then prove that the sum of three even functions is an even function. 8. (a) $2\pi/3.$ ▲ Suppose that the constant number $T \neq 0$ is a period of the given function. Then,

$\sin 3x = \sin 3(x + T)$ or $2 \cos\left(3x + \frac{3T}{2}\right) \sin \frac{3T}{2} = 0$ for any

$x \in \mathbb{R}.$ This is evidently possible if $\sin(3T/2) = 0$, i.e. $3T/2 = \pi n$, $n \in \mathbb{Z}.$ And since we have to find the least positive number T , this number can be found from the equation $3T/2 = \pi$ ($n = 1$); (b) $2\pi.$

● Represent the function in the form $y = (\sin x + \sin 2x + \sin 5x)/\cos 2x$; (c) 4π ; (d) $\pi.$ ● $\cos^2 x = 1/2 + (\cos 2x)/2$; (e) 2π ; (f) π ; (g) $70\pi.$ 9. ● Show that the conditions of the definition of a periodic function are not fulfilled for this function. 10. $\{-2, -1; 1, 2\}.$

11. ● Prove that $\cos \frac{x_1 + x_2}{2} \sin \frac{x_2 - x_1}{2} > 0$ for any $x_1, x_2 \in$

$\in \left(0; \frac{\pi}{2}\right), x_2 > x_1.$

12. (a)

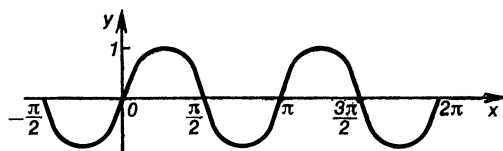

12. (b)

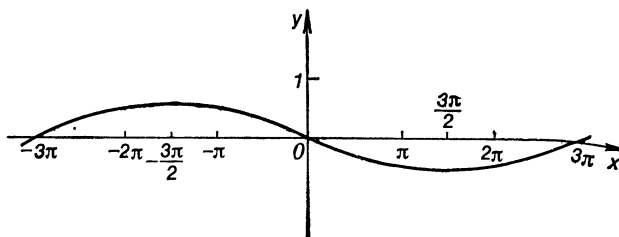

12. (c)

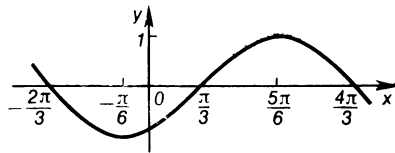

12. (d)

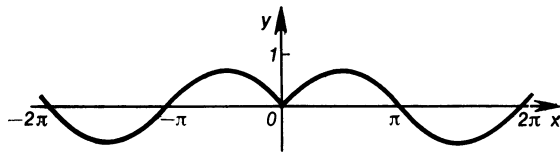

12. (e)

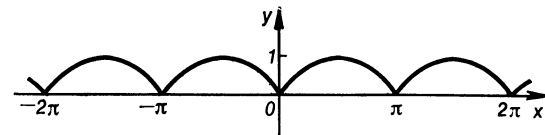

12. (f)

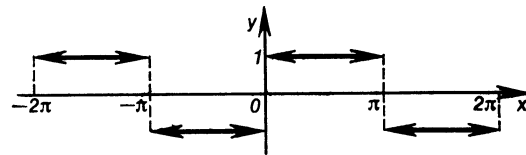

12. (g)

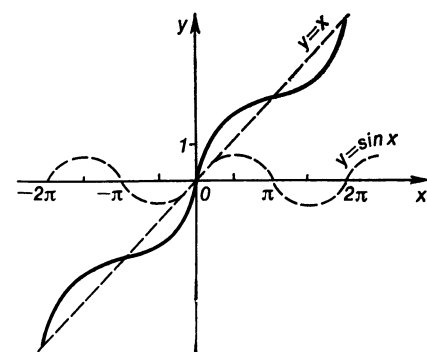

13*

12. (h)

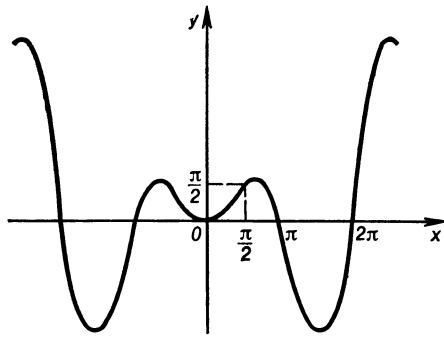

12. (i)

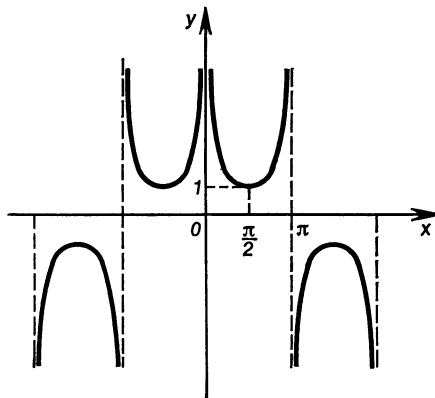

12. (j)

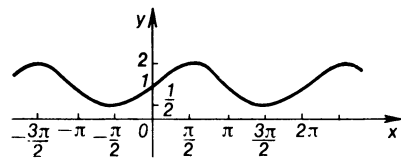

12. (k)

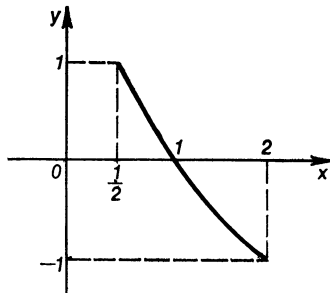

13. (a)

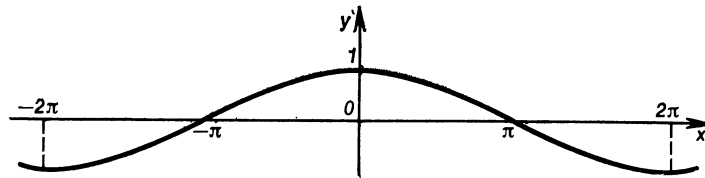

13. (b)

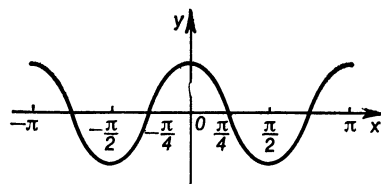

13. (c)

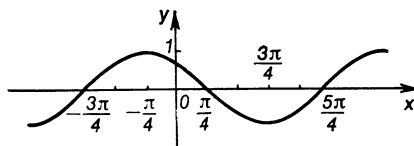

13. (d)

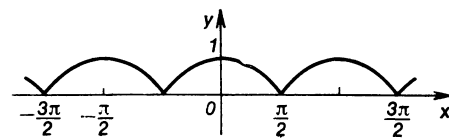

13. (e)

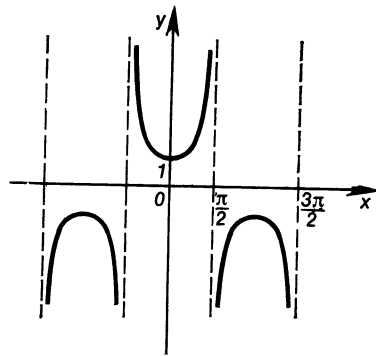

14. (a)

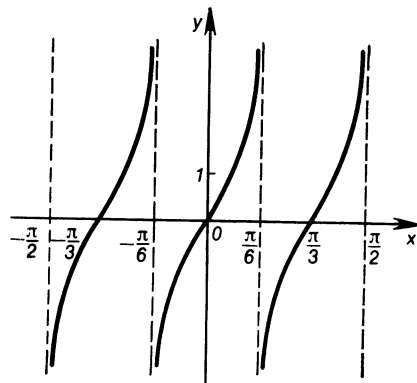

14. (b)

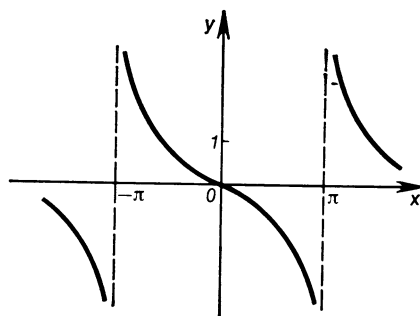

14. (c)

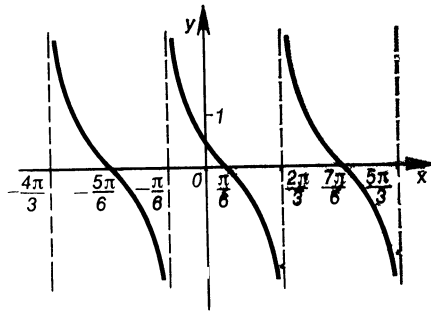

14. (d)

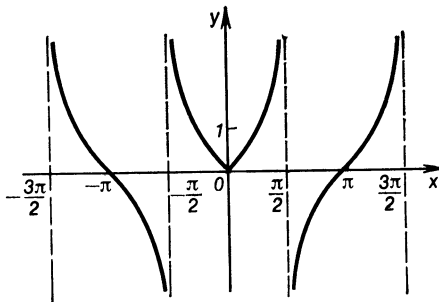

14. (e)

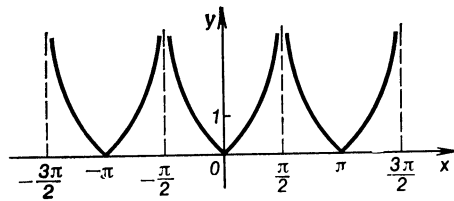

14. (f)

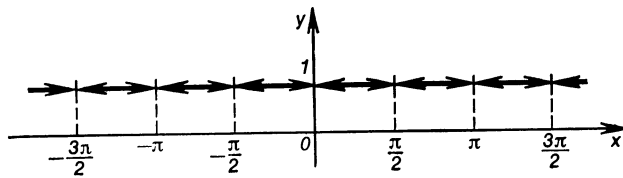

15. (a)

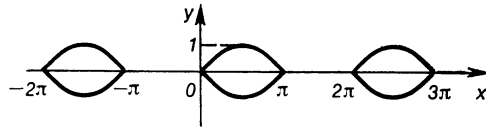

15. (b)

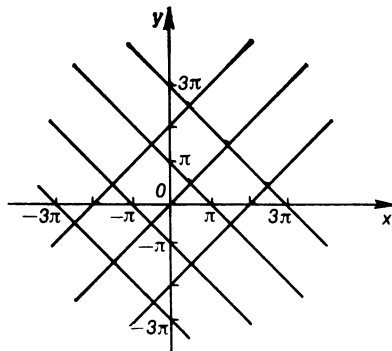

16. (a) $\cos x + \sin x$; (b) $-(4 \cos 2x / \sin^2 2x)$; (c) $\sin 2x$; (d) $-\sin 2x$;
 (e) $\tan^2 x (\tan^2 x + 1)$; (f) $-\cot^3 x (\cot^2 x + 1)$; (g) $3 \cos 3x$;
 (h) $(-1/\sqrt{2}) \sin(x/\sqrt{2})$; (i) $2 \sin(4x - 2)$; (j) $[-3 \cos^2(x^2 + x) \times$
 $\times \sin(x^2 + x)](2x + 1)$; (k) $1/(1 + \cos x)$. 17. (a) $\sqrt{3}/2$; (b) -2 ;
 (c) 3. 18. (a) $y - 2 = 0$; (b) $y - 1/2 = \pi/4 - x$; (c) $y - 1 =$
 $= 4(x - \pi/8)$. 19. $\max_{x \in \mathbb{R}} y = 21$; $\min_{x \in \mathbb{R}} y = -19$. 20. $3/4$. \blacktriangle Since
 $f'(x) = 0$ for any $x \in \mathbb{R}$, it follows that $f(x) = \text{const}$, and the value
 of the constant can be found by substituting any value of x , say,
 $x = 0$.

2.6. Inverse Trigonometric Functions

1. (a) $D(y) = [0, 2]$; (b) $D(y) = [2, 6]$; (c) $D(y) = [-1 - \sqrt{2};$
 $\sqrt{2} - 1]$; (d) $D(y) = (-\infty; \infty)$; (e) $D(y) = (-\infty; \infty)$; (f) $D(y) =$
 $= (-\infty; \infty)$. \bullet To find the domain of definition of the function
 $y = \arcsin f(x)$ ($y = \arccos f(x)$), solve the inequality $|f(x)| \leq 1$.
 2. (a) $D(y) = (-\infty; \infty)$; (b) $D(y) = [0, \infty)$; (c) $D(y) = (0, \infty)$;
 (d) $D(y) = (-\infty; \infty)$. 3. (a) $E(y) = [0, \pi/2]$; (b) $E(y) = (\pi/2, \pi]$;
 (c) $E(y) = (0, \pi/2)$; (d) $E(y) = [\pi/4, \pi)$. 4. (a) \blacktriangle Setting $|x| = t$,
 where $x \in [-1; 1]$ and $t \in [0; 1]$, we get, by the definition,
 $\sin(\arcsin t) = t = |x|$; (b) \blacktriangle Suppose $\arcsin x = \alpha$, with
 $\alpha \in [-\pi/2; \pi/2]$. (1)

Thus, we have to find the value $\cos \alpha$ if $\sin \alpha = x$. From the prin-
 cipal identity $\sin^2 \alpha + \cos^2 \alpha = 1$ or $\cos^2 \alpha = 1 - x^2$ we have $|\cos \alpha| =$
 $= \sqrt{1 - x^2}$. And since the values of α satisfy condition (1), it

follows that $\cos \alpha = \cos(\arcsin x) = \sqrt{1-x^2}$; (c) \blacktriangle Since $\tan \alpha = \sin \alpha / \cos \alpha$, we have $\tan \alpha = \tan(\arcsin x) = x / \sqrt{1-x^2}$ for $x \in (-1, 1)$. 5. (a) $4\sqrt{2}/9$. \blacktriangle Suppose $\arcsin \frac{1}{3} = \alpha$. Then $\sin \left(2 \arcsin \frac{1}{3} \right) = \sin 2\alpha = 2 \sin \alpha \cos \alpha = 2 \cdot (1/3) \sqrt{1-1/9} = 4\sqrt{2}/9$; (b) $7/9$; (c) $4\sqrt{2}/7$; (d) $23/27$. \blacktriangle $\sin(3 \arcsin(1/3)) = \sin 3\alpha = 3 \sin \alpha - 4 \sin^3 \alpha = (3/3) - 4 \cdot 1/27 = 23/27$; (e) $\sqrt{2}/4$. \blacktriangle If we introduce the designation $\arcsin \sqrt{63}/8 = \beta$, then we have $\sin \beta = \sqrt{63}/8$, $\cos \beta = \sqrt{1-63/64} = 1/8$. Now we can find $\cos(\beta/2) = \sqrt{(1+\cos \beta)/2} = \sqrt{9/16} = (3/4)$ ($\beta/2 \in (0, \pi/4)$); by the formula $\frac{\sin(\beta/4)}{1-\cos(\beta/2)}$ we find $\sin \left(\frac{1}{4} \arcsin \frac{\sqrt{63}}{8} \right) = \sqrt{\frac{1-3/4}{2}} = \sqrt{\frac{1}{8}} = \frac{\sqrt{2}}{4}$. 6. (b) \blacktriangle Suppose

$$\arccos x = \alpha, \alpha \in [0; \pi]. \quad (1)$$

From the principal identity we have $\sin^2 \alpha = 1 - x^2$ or $|\sin \alpha| = \sqrt{1-x^2}$, or, by virtue of (1), $\sin \alpha = \sin(\arccos x) = \sqrt{1-x^2}$; (c) $\tan \alpha = \sin \alpha / \cos \alpha = \sqrt{1-x^2}/x$, $x \in [-1, 0) \cup (0, 1]$. 7. (a) $-11/16$. \blacktriangle Let us introduce the designation $\arccos(1/4) = \alpha$. Then we have $\cos(3 \arccos(1/4)) = \cos 3\alpha = 4 \cos^3 \alpha - 3 \cos \alpha = \frac{4}{64} - \frac{3}{4} = -\frac{11}{16}$; (b) $2/3$; (c) $1/4$. 8. (b) \blacktriangle Suppose $\arctan x = \alpha$, $\alpha \in (-\pi/2; \pi/2)$. Then $\tan \alpha = x$ and, taking (1) into account, we find $\cos \alpha = 1/\sqrt{1+\tan^2 \alpha} = 1/\sqrt{1+x^2}$ from the identity $\tan^2 \alpha + 1 = 1/\cos^2 \alpha$. 9. (a) $3/5$. \blacktriangle Let us introduce the designation $\arctan 3 = \alpha$, $\tan \alpha = 3$. Then we get $\sin(2 \arctan 3) = \sin 2\alpha = 2 \tan \alpha / (1 + \tan^2 \alpha) = 2 \cdot 3 / (1 + 3^2) = 3/5$; (b) $-3/4$; (c) $\sqrt{(10 - \sqrt{10})}/20$. \blacktriangle $\sin(\alpha/2) = \sqrt{(1 - \cos \alpha)/2} = \sqrt{(1 - 1/\sqrt{1+9})/2} = \sqrt{(\sqrt{10} - 1)/2} / \sqrt{10} = \sqrt{(10 - \sqrt{10})}/20$; (d) $\sqrt{(26 + \sqrt{26})}/52$; (e) $3/\sqrt{10}$. 10. (b) \blacktriangle Suppose $\arctan x = \alpha$; $\cot \alpha = x$. Then $\tan \alpha = 1/\cot \alpha = 1/x$. 11. (a) \blacktriangle Assume $\arcsin x = \arccos y$ (which is possible since $0 \leq x \leq 1$). Then $\cos(\arccos y) = \cos(\arcsin x)$, $y = \sqrt{1-x^2}$, i.e. $\arcsin x = \arccos \sqrt{1-x^2}$. 12. (a) $\arccos(4/5)$; $\arctan(3/4)$; $\text{arccot}(4/3)$; (b) $\arcsin(5/13)$; $\arctan(5/12)$, $\text{arccot}(12/5)$; (c) $\arcsin(5/13)$; $\arccos(12/13)$; $\text{arccot}(12/5)$; (d) $\arcsin(4/5)$; $\arccos(3/5)$; $\arctan(4/3)$. 13. (a) \blacktriangle We set $\arcsin(-x) = \alpha$, $\alpha \in [-\pi/2; \pi/2]$. Then we have $\sin \alpha = -x$ or $-\sin \alpha = \sin(-\alpha) = x$, whence it follows that $-\alpha = \arcsin x$ or $\alpha = \arcsin(-x) = -\arcsin x$; (c) \blacktriangle Assume $\arccos(-x) = \alpha$, $\alpha \in [0; \pi]$. Then $\cos \alpha = -x$ or $-\cos \alpha = \cos(\pi - \alpha) = x$. Since $0 \leq \pi - \alpha \leq \pi$, we have $\pi - \alpha = \arccos x$, i.e. $\alpha = \arccos(-x) = \pi - \arccos x$. 14. (a) $\pi - \arcsin(2\sqrt{2}/3)$; $\pi - \arctan 2\sqrt{2}$; $\text{arccot}(-\sqrt{2}/4)$; $\pi - \text{arccot}(\sqrt{2}/4)$; $\pi - \arccos(1/3)$; (b) $\arcsin(-7/25)$; $-\arccos(24/25)$; $-\text{arccot}(24/7)$; $-\arctan(7/24)$; (c) $\pi - \arcsin(24/25)$;

$\arccos(-7/25); \pi - \arctan(24/7); \pi - \arccos(7/25); \pi - \operatorname{arccot}(7/24)$.
 15. (a) \blacktriangle Since $0 \leq x \leq 1, 0 \leq y \leq 1$, it follows that $0 \leq \arcsin x \leq \pi/2; 0 \leq \arcsin y \leq \pi/2$ and $0 \leq \arcsin x + \arcsin y \leq \pi$. Therefore, we can write the equation $\arcsin x + \arcsin y = \arccos z$, whence we have $\cos(\arcsin x + \arcsin y) = \cos(\arccos z)$, $z = \sqrt{1-x^2}\sqrt{1-y^2} - xy$; (d) \blacktriangle Since $0 \leq \arccos x \leq \pi/2$ and $-\pi/2 \leq -\arccos y \leq 0$, we have $-\pi/2 \leq \arccos x - \arccos y \leq \pi/2$ and we can write the equation $\arccos x - \arccos y = \arcsin z$. Hence it follows that $\sin(\arccos x - \arccos y) = \sin(\arcsin z)$ or $z = y\sqrt{1-x^2} - x\sqrt{1-y^2}$; (h) \blacktriangle We have $x > 0, y > 0$ and, therefore, $0 < \operatorname{arccot} x < \pi/2, 0 < \operatorname{arccot} y < \pi/2, 0 < \operatorname{arccot} x + \operatorname{arccot} y < \pi$, and we have an equation $\operatorname{arccot} x + \operatorname{arccot} y = \operatorname{arccot} z$ or $\cot(\operatorname{arccot} x + \operatorname{arccot} y) = \cot(\operatorname{arccot} z)$. Using the formula $\cot(\alpha + \beta) = (\cot \alpha \cot \beta - 1)/(\cot \alpha + \cot \beta)$, we obtain $z = (xy - 1)/(x + y)$. 16. (a) $\arccos(-16/65)$; (b) $\arccos(-3/5)$; (c) $\operatorname{arccot}(-19/9)$; (d) $-\arcsin(3/5)$; (e) $-\arcsin(36/325)$; (f) $-\arctan(1/21)$; (g) $-\arctan(1/21)$. 17. (a) \blacktriangle We introduce the designation $\arcsin x + \arccos x = \alpha$. Since $-\pi/2 \leq \arcsin x \leq \pi/2, 0 \leq \arccos x \leq \pi$, we have $-\pi/2 \leq \alpha \leq 3\pi/2$; since $\sin \alpha = \sin(\arcsin x + \arccos x) = xx + \sqrt{1-x^2}\sqrt{1-x^2} = 1$, it follows that $\alpha = \pi/2$; (b) suppose $\arctan x + \operatorname{arccot} x = \beta$; since $-\pi/2 < \arctan x < \pi/2, 0 < \operatorname{arccot} x < \pi$, it follows that $-\pi/2 < \beta < 3\pi/2$. Since $\sin \beta = \sin(\arctan x + \operatorname{arccot} x) = x^2/(1+x^2) + 1/(1+x^2) = 1$, we have $\beta = \pi/2$. 18. (a) $\{1/2\}$; (b) $\{1\}$; (c) $\{1\}$. 19. $k = 2; \{(\cos(\pi^2/4); 1); (\cos(\pi^2/4); -1)\}$. 20. $\max_{[-1;1]} f(x) = (-1) = 7\pi^3/8; \min_{[-1;1]} f(x) = f(1/2) = \pi^3/32$. \blacktriangle Since $\arcsin x + \arccos x = \pi/2$, we can, putting $\arccos x = t$, reduce the original function to the form $\frac{\pi}{2} \left(3t^3 - \frac{3}{2} \pi t + \frac{\pi^2}{4} \right)$. The function $f(t)$ assumes the least value at $t = \frac{\pi}{4} \left(x = \frac{1}{\sqrt{2}} \right)$, and the greatest value at $t = \pi \left(x = -1 \right)$. 21. (a) $-3\pi/7$. \blacktriangle From the definition of the inverse function $y = \arcsin x$ it follows that $\arcsin(\sin x) = x$ if $x \in [-\pi/2; \pi/2]$. To be able to apply this formula, we make the transformation $\sin(10\pi/7) = \sin(\pi + 3\pi/7) = -\sin(3\pi/7) = \sin(-3\pi/7)$. Thus we have $\arcsin(\sin 10\pi/7) = \arcsin(\sin(-3\pi/7)) = -3\pi/7$ ($-3\pi/7 > -\pi/2$); (b) $11\pi/18$; (c) $-\pi/5$.

22. (a)

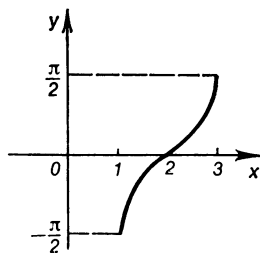

22. (b)

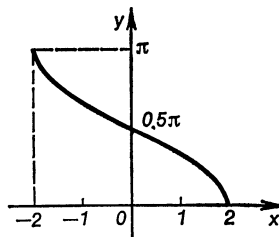

22. (a)

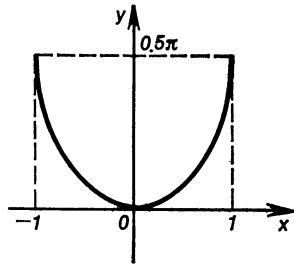

22. (d)

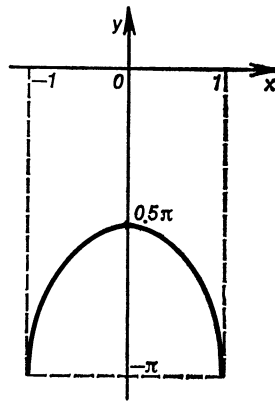

23. (a)

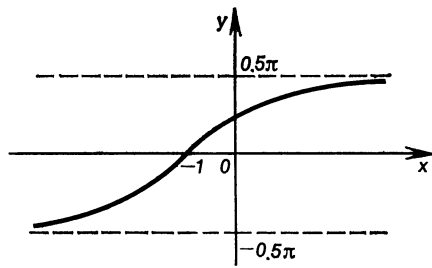

23. (b)

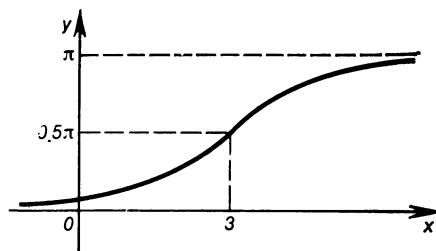

23. (c)

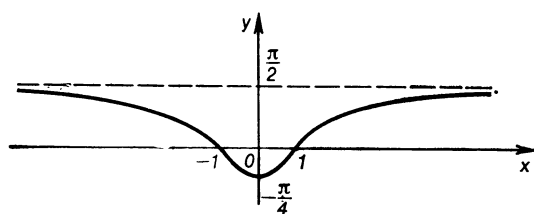

23. (d)

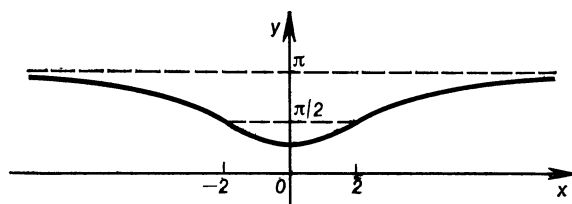

24. (a)

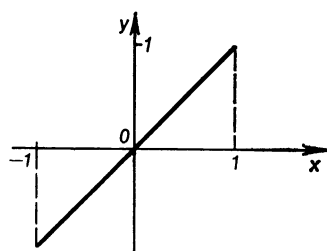

24. (b)

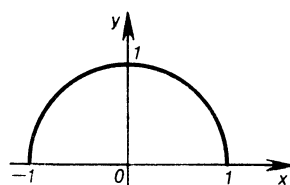

24. (c)

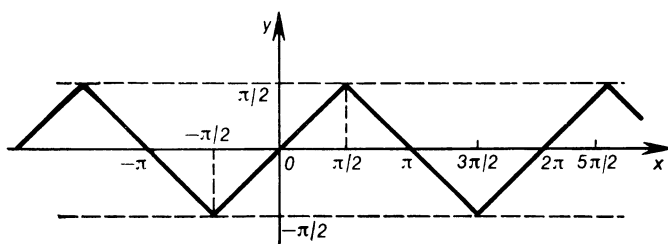

25. (a) Suppose $f(x) = \sin x$. Then, by the formula for the derivative of the inverse function $g'(x) = \frac{1}{f'(g(x))}$ ($g(x) = \arcsin x$), we find

$$(\arcsin x)' = \frac{1}{f'(\arcsin x)} = \frac{1}{\cos(\arcsin x)} = \frac{1}{\sqrt{1-x^2}};$$

(b) the proof is similar to that carried out in (a); (c) suppose $f(x) = \tan x$, $g(x) = \arctan x$; we have

$$\begin{aligned} (\arctan x)' &= \frac{1}{f'(\arctan x)} = \cos^2(\arctan x) \\ &= \frac{1}{\tan^2(\arctan x) + 1} = \frac{1}{1+x^2}; \end{aligned}$$

(d) the proof is similar to that carried out in (c). 26. (a) $-1/\sqrt{2x-x^2}$;

(b) $-1/\sqrt{1-(x+2)^2}$; (g) $1/\sqrt{4-x^2} - 2/\sqrt{1-4x^2}$; (d) $\arcsin x +$

$x/\sqrt{1-x^2}$; (e) $-\frac{x + (\arccos x) \frac{1}{\sqrt{1-x^2}}}{x^2 \sqrt{1-x^2}}$; (f) $\frac{\pi}{2(\arccos x)^2 \sqrt{1-x^2}}$;

(g) $2x/(1+x^4)$; (h) $-(2^x \ln 2)/(1+4^x)$; (i) $\cos x / |\cos x|$;

(j) $-1/((1+x)\sqrt{2x(1-x)})$. 27. (a) 4; (b) $3\sqrt{2}$; (c) 1.5; (d) 0.8.

28. (a) $y = 15x/4 - 3/4 + \arcsin(3/5)$; (b) $y = x/4 + 1/2 - \pi/4$.

29. (a) $\{0\}$; (b) $\{0\}$. \blacktriangle The given function is differentiable at any point $x \in \mathbb{R}$ and, therefore, only those values of x_0 at which $y'(x_0) = 0$ can be its critical points. Differentiating, we get $y'(x) = \arctan x + x/(1+x^2)$. The equation $\arctan x + x/(1+x^2) = 0$ has the unique solution $x = 0$ (the function $\varphi(x) = y'(x)$ being odd and assuming only positive values for all $x > 0$). 30. $\max y = y(0) = \pi/4$;

$$\min y = y(1) = 0.$$

[0;1]

2.7. Trigonometric Equations and Systems of Equations

1. (a) $\{\pi n + (-1)^{n+1} \pi/6 \mid n \in \mathbb{Z}\}$; (b) $\{\pi n + \pi/8 \mid n \in \mathbb{Z}\}$;
(c) $\{\pi n/2 \mid n \in \mathbb{Z}\}$. \bullet The original equation is equivalent to the equation $\sin 2x = 0$; (d) $\{2\pi n + (-1)^n 2 \arcsin(1/4) + 2\pi/3 \mid n \in \mathbb{Z}\}$.

\bullet Represent the left-hand side of the equation in the form $\sin(x/2 - \pi/3)$; (e) $\left\{ \frac{\pi^2}{4} (4n-1)^2 \mid n \in \mathbb{N} \right\}$. \blacktriangle We reduce the original

equation to the equation $\sqrt{x} = 2\pi n - \pi/2$, which has solutions if $2\pi n - \pi/2 \geq 0$ or $n \geq 1/4$. But since $n \in \mathbb{Z}$, the last inequality can be only satisfied for $n \in \mathbb{N}$. 2. (a) $\{\pi n + \pi/2 \mid n \in \mathbb{Z}\}$; (b) $\{2\pi n/3 + 7\pi/18 \mid n \in \mathbb{Z}\}$; (c) $\{2\pi n \pm 2\pi/3 \mid n \in \mathbb{Z}\}$. \bullet $\sin^4(x/2) - \cos^4(x/2) = -\cos x$; (d) $\{2\pi n \pm \arccos(\pi/4) - \pi/6 \mid n \in \mathbb{Z}\}$. \bullet Represent the left-hand side of the equation in the form $\cos(x + \pi/6)$;

(e) $\{\pm \sqrt{2\pi n} \mid n \in \mathbb{Z}_0\}$. 3. $\{\pi n + (-1)^{n+1} \pi/4 \mid n \in \mathbb{Z}\}$. \bullet Show that the equation $\sin x - 13 + \sqrt{2}/2 = 12k - 1$ has a solution only for

$k = -1$ and the equation $\sin x - 13 + \sqrt{2}/2 = 12k + 1$ does not have solutions for $k \in \mathbb{Z}$.

4. $[-1, 7/3]$. ● Solve the inequality $|(a-1.5)/(2-0.5a)| \leq 1$.

5. (a) $\left\{ 2\pi n \pm \left(\pi - \arccos \frac{2}{3} \right) \mid n \in \mathbb{Z} \right\}$; (b) $\left\{ \frac{\pi n}{2} + \frac{(-1)^n}{2} \times \arcsin \frac{a}{2} \mid n \in \mathbb{Z} \right\}$ for $a \in [-2, 2]$. The function has no critical

points if $a \notin [-2, 2]$. 6. (a) $\{\pi n + \pi/6 \mid n \in \mathbb{Z}\}$; (b) $\{2\pi n - 3\pi/14 \mid n \in \mathbb{Z}\}$;

(c) $\left\{ \frac{\pi n}{2} + \frac{1}{2} \arctan 5 \mid n \in \mathbb{Z} \right\}$. ● $\tan 2x = 2 \tan x / (1 - \tan^2 x)$;

(d) $\{\pi n - \pi/12 \mid n \in \mathbb{Z}\}$. ● Represent the left-hand side of the equation

in the form $\tan(\pi/4 - x)$. 7. (a) $\{\pi n + \pi/4 \mid n \in \mathbb{Z}\}$; (b) $\left\{ \frac{\pi n}{2} + \right.$

$\left. \frac{1}{2} \operatorname{arccot} 2 - \frac{\pi}{6} \mid n \in \mathbb{Z} \right\}$; (c) $\{2\pi n + 3\pi/2 + 6 \mid n \in \mathbb{Z}\}$; (d) $\{\pi n +$

$+\operatorname{arccot}(\sqrt{7} - \sqrt{2}) \mid n \in \mathbb{Z}\}$. 8. (a) $\{\pi n, 2\pi n \pm 3\pi/4 \mid n \in \mathbb{Z}\}$;

(b) $\{2\pi n \pm \pi/6; 2\pi n + \pi/2 \mid n \in \mathbb{Z}\}$; (c) $\left\{ \frac{\pi n}{2} + (-1)^n \frac{\pi}{12} \mid n \in \mathbb{Z} \right\}$;

(d) $\left\{ \frac{\pi n}{3}; \frac{2\pi n}{3} \pm \frac{1}{3} \arccos \frac{1}{\sqrt{2}} \mid n \in \mathbb{Z} \right\}$; (e) $\{\pi n + \pi/4; 2\pi n \pm$

$\pi/3 \mid n \in \mathbb{Z}\}$. 9. (a) $\{\pi n + (-1)^{n+1} \pi/6 \mid n \in \mathbb{Z}\}$; (b) $\{2\pi n \pm \pi/3 \mid n \in$

$\in \mathbb{Z}\}$; (c) $\{\pi n + (-1)^n \arcsin(2/3) \mid n \in \mathbb{Z}\}$; (d) $\{2\pi n \pm 2\pi/3 \mid n \in \mathbb{Z}\}$;

(e) $\{\pi(5n+2) \pm \pi/2; 5\pi n \mid n \in \mathbb{Z}\}$; (f) $\{\pi n, 2\pi n + \pi/6 \mid n \in \mathbb{Z}\}$.

10. (a) $\{\pi n + \pi/4; \pi n + \arctan 3 \mid n \in \mathbb{Z}\}$; (b) $\{\pi n - \arctan(1/2);$

$\pi n + \arctan 2 \mid n \in \mathbb{Z}\}$; (c) $\{\pi n + \pi/6; \pi n + \pi/3 \mid n \in \mathbb{Z}\}$;

(d) $\{\pi n + 3\pi/4; \pi n + \operatorname{arccot} 2 \mid n \in \mathbb{Z}\}$. 11. (a) $\{\pi n + (-1)^{n+1} \frac{\pi}{4} \mid n \in$

$\in \mathbb{Z}\}$; (b) $\{\pi n + (-1)^n \pi/4 \mid n \in \mathbb{Z}\}$; (e) $\{2\pi n + \arctan(1/2) \mid n \in \mathbb{Z}\}$.

▲ Using the formulas for the logarithms of a product and a quotient,

we reduce the equation to the form

$$\log_3 \frac{3 \sin x}{\cos x (1 - \tan x) (1 + \tan x)} = 1 \quad \text{or} \quad 3 \tan x = 2(1 - \tan^2 x).$$

Solving now the equation with respect to $\tan x$, we obtain $(\tan x)_1 = -2$ and $(\tan x)_2 = 1/2$. Since, as a result of the transformations, we have obtained an equation which is not equivalent to the given equation, verification must be carried out. Only those values of x can be solutions of the original equation for which the following system of inequalities is consistent:

$$\begin{cases} \sin x > 0, \\ \cos x > 0, \\ 1 - \tan x > 0, \\ 1 + \tan x > 0. \end{cases}$$

The solutions of the equation $\tan x = -2$ do not satisfy the inequality $1 + \tan x > 0$ of the system and are, therefore, extraneous.

The equation $\tan x = 1/2$ has solutions $x = \pi k + \arctan(1/2)$, $k \in \mathbb{Z}$. Verifying them by means of the substitution into the inequalities $\sin x > 0$ and $\cos x > 0$, we find that the inequalities hold for $k = 2n$, $n \in \mathbb{Z}$.

12. (a) $\{\pi n/2 + \pi/8 \mid n \in \mathbb{Z}\}$; (b) $\left\{\frac{\pi n}{2} + \frac{(-1)^n}{2} \arcsin 2(2 - \sqrt{3}) \mid n \in \mathbb{Z}\right\}$;

(c) $\left\{\frac{\pi n}{2} + \frac{(-1)^n}{2} \arcsin(1 - \sqrt{3+2a}) \mid n \in \mathbb{Z}\right\}$ for $a \in \left[-\frac{3}{2}; \frac{1}{2}\right]$;

\emptyset for $a \notin [-3/2; 1/2]$; (d) $\left\{\frac{\pi n}{2} + (-1)^{n+1} \frac{\pi}{12} \mid n \in \mathbb{Z}\right\}$; (e) $\left\{\frac{\pi n}{5}$;

$\frac{2\pi n}{5} \pm \frac{1}{5} \arccos \frac{1}{4} \mid n \in \mathbb{Z}\right\}$. 13. (a) $\left\{\pi n + (-1)^n \arcsin \frac{\sqrt{33}-3}{4} \mid n \in \mathbb{Z}\right\}$;

(b) $\left\{\pi n/5 + (-1)^n \pi/20 - \frac{6}{5} \mid n \in \mathbb{Z}\right\}$; (c) $\{\pi n/2 + \pi/4 \mid n \in \mathbb{Z}\}$.

● Use the equality $2 \sin^2 x = 1 - \cos 2x$; (d) $\left\{2\pi n \pm$

$\pm \arccos \frac{1 - \sqrt{1+4a^2}}{2a} \mid n \in \mathbb{Z}\right\}$ for $a \neq 0$, $\{\pi n + \pi/2 \mid n \in \mathbb{Z}\}$ for

$a = 0$. 14. (a) $\left\{\pi/2 + 2\pi n \mid n \in -\mathbb{N}; \frac{3}{2}; -\pi/2 + 2\pi m \mid m \in \mathbb{N}\right\}$.

▲ After the simplest transformations, the given function can be represented in the form $f(x) = 2 \cos x - |2x - 3| + e^x - 2$. It can be seen that it is differentiable everywhere except for the point $x = 3/2$, i.e. this point is critical. We have $f(x) = 2 \cos x + 2x + e^x - 5$ for $x < 3/2$, $f(x) = 2 \cos x - 2x + e^x + 1$ for $x > 3/2$. We can find other critical points by differentiating the function and equating the derivative to zero (taking the inequality into account);

(b) $\{(\pi/2 + 2\pi m)/6 \mid m = 1, 0, -1, -2, \dots; 2; \frac{1}{6}(-\pi/2 + 2\pi n)$

$\mid n = 3, 4, 5, \dots\}$; (c) $\{\pi(2n+1)/2 \mid n \in \mathbb{Z}\}$; (d) $\{2\pi n \pm 3\pi/4 \mid n \in \mathbb{Z}\}$. ▲ The given function is differentiable at every point belonging to the interval $(-\infty; \infty)$. Differentiating the function and equating the derivative to zero, we get an equation $2 \cos^2 x + (\sqrt{2} - 2\sqrt{5}) \times$

$\times \cos x - \sqrt{10} = 0$. Hence we obtain $\cos x = \sqrt{5}$ (the set of solutions of this equation is empty) and $\cos x = -2/\sqrt{2} \Rightarrow x = 2\pi n \pm$

$\pm 3\pi/4; n \in \mathbb{Z}$; (e) $\{(-1)^{n+1} \frac{\pi}{4} + \pi n \mid n \in \mathbb{Z}\}$. 15. (a) $\{\pi(2n+1) \mid n \in \mathbb{Z}\}$. ▲ Taking into account that $2 \cos^2(x/2) = 1 + \cos x$, we

reduce the equation to the form $\cos^3 x + \cos^2 x - 2(\cos x + 1) = 0$ or $(\cos x + 1)(\cos^2 x - 2) = 0$. Thus we have two equations: $1 +$

$+\cos x = 0$, whose solution is $-x = 2\pi n + \pi, n \in \mathbb{Z}$, and $\cos^2 x -$

$-2 = 0$, which has no solutions; (b) $\{\pi n + \pi/2; 2\pi n \pm \pi/3; 2\pi n \pm$

$\pm(\pi - \arccos(2/3)) \mid n \in \mathbb{Z}\}$; (c) $\{\pi n - \pi/4; \pi n \pm \pi/3 \mid n \in \mathbb{Z}\}$. ● Make use of the identity $1/\cos^2 x - 1 = \tan^2 x$ and reduce the equation to the form $(\tan x + 1)(\tan^2 x - 3) = 0$; (d) $\{2\pi n; 2\pi n \pm$

$\pm 2\pi/3; 2\pi n \pm \arccos((-1 \pm \sqrt{5})/4) \mid n \in \mathbb{Z}\}$. 16. (a) $\{\pi n + \arctan 5 \mid n \in \mathbb{Z}\}$. ▲ The two sides of the equation do not vanish simultaneous-

y for any x ; dividing the equation by $\cos x$, we get an equation $\sin x/\cos x = \tan x = 5$, which is equivalent to the given equation. The solutions of the latter equation can be found from the formula $x = \pi n + \arctan 5$, $n \in \mathbb{Z}$; (b) $\{\pi n + \pi/4 \mid n \in \mathbb{Z}\}$; (c) $\{\pi n - \pi/4 \mid n \in \mathbb{Z}\}$; (d) $\{2\pi n - \pi/4; 2\pi n + \pi/2 \mid n \in \mathbb{Z}\}$; (e) $\{\pi n + \pi/2; \pi n + \arctan(1/4) \mid n \in \mathbb{Z}\}$; 17. (a) $\{\pi n + \pi/4; 2\pi n \pm 2\pi/3 \mid n \in \mathbb{Z}\}$; (b) $\{\pi n + \arctan 2 \mid n \in \mathbb{Z}\}$; (c) $\{2\pi n; \pi n + \pi/4 \mid n \in \mathbb{Z}\}$; (d) $\{\pi n - \pi/4; \pi n \mid n \in \mathbb{Z}\}$; (e) $\{\pi n + \pi/4 \mid n \in \mathbb{Z}\}$. ● Reduce the right-hand side of the equation to the form $(\cos x - \sin x)^2 + \cos^2 x - \sin^2 x$. 18. (a) $\{\pi n - \pi/4; \pi n - \arctan 2 \mid n \in \mathbb{Z}\}$. ▲ Since $\sin x$ and $\cos x$ do not vanish at the same value of x , we can divide the equation by $\cos^2 x$. We get an equation

$$\tan^2 x + 3 \tan x + 2 = 0 \quad (1)$$

which is equivalent to the original equation. From (1) we get equations $\tan x = -1$ and $\tan x = -2$, whose solutions can be found from the familiar formulas; (b) $\{\pi n + \pi/4; \pi n - \arctan(1/4) \mid n \in \mathbb{Z}\}$; (c) $\{\pi n + \pi/4; \pi n + \arctan(3/5) \mid n \in \mathbb{Z}\}$; (d) $\{\pi n + \arctan 2; \pi n - \arctan(3/4) \mid n \in \mathbb{Z}\}$. ● Represent the right-hand side of the equation in the form $-2(\sin^2 x + \cos^2 x)$; (e) $\{\pi n - \pi/4; \pi n + \arctan 5 \mid n \in \mathbb{Z}\}$. 19. (a) $\{\pi n - \arctan \sqrt[3]{4} \mid n \in \mathbb{Z}\}$; (b) $\{\pi n - \pi/4; \pi n \pm \pi/3 \mid n \in \mathbb{Z}\}$. ▲ We transform the right-hand side of the equation as follows: $3 \sin x (\cos x - \sin x) + 3 = 3 \sin x \times (\cos x - \sin x) + 3 \sin^2 x + 3(\sin^2 x + \cos^2 x) = 3 \cos x (\sin x + \cos x)$. We have got an equation $\sin^2 x (1 + \tan x) = 3 \cos^2 x (1 + \tan x)$, or $(1 + \tan x)(\tan^2 x - 3) = 0$, whose solution reduces to that of the equations $\tan x = -1$, $\tan x = \sqrt{3}$ and $\tan x = -\sqrt{3}$; (c) $\{\pi n/2 \mid n \in \mathbb{Z}\}$. ● Represent the right-hand side of the equation in the form $1 = (\sin^2 x + \cos^2 x)^2 = \sin^4 x + 2 \sin^2 x \cos^2 x + \cos^4 x$; (b) $\{\pi n/2 \mid n \in \mathbb{Z}\}$ for $a = 0$; $\{\pi n + \arctan \frac{1}{2a} \mid n \in \mathbb{Z}\}$ for $a \neq 0$. 20. (a) $\left\{ \frac{\pi n}{2} - \frac{1}{2} \arctan \frac{5}{3} \mid n \in \mathbb{Z} \right\}$; (b) $\{\pi n + \arctan(6 \pm \sqrt{3}) \mid n \in \mathbb{Z}\}$; (c) $\{\pi n + (-1)^{n+1} \pi/6 \mid n \in \mathbb{Z}\}$; (d) $\{\pi n - \arctan(1/2) \mid n \in \mathbb{Z}\}$; (e) $\{\pi n \pm \pi/6 \mid n \in \mathbb{Z}\}$. 21. (a) $\{2\pi n; 2\pi n + \pi/3 \mid n \in \mathbb{Z}\}$; (b) $\left\{ 2\pi n + \frac{\pi}{12}, 2\pi n + \frac{7\pi}{12} \mid n \in \mathbb{Z} \right\}$; (c) $\left\{ \frac{2\pi n}{5} - \frac{\pi}{5}; \frac{2\pi n}{5} + \frac{2\pi}{15} \mid n \in \mathbb{Z} \right\}$; (d) $\{2\pi n; 2\pi n + \pi/2 \mid n \in \mathbb{Z}\}$; (e) $\{2\pi n + 5\pi/3 \mid n \in \mathbb{Z}\}$; (f) $\left\{ \frac{\pi}{12}; \frac{\pi}{12} \times (2n+1); \frac{\pi}{8}(1-2n) \mid n \in \mathbb{N} \right\}$; (g) $\left\{ 2\pi n \pm \arccos \frac{a}{\sqrt{2}} - \frac{\pi}{4} \mid n \in \mathbb{Z} \right\}$ for $a \in [-\sqrt{2}; \sqrt{2}]$; \emptyset for $a \notin [-\sqrt{2}; \sqrt{2}]$; (h) $\left\{ \pi n + \frac{7\pi}{12} \mid n \in \mathbb{Z} \right\}$; (i) $\{\pi n/4 \mid n \in \mathbb{Z}, \text{ except for } n = 4k+2, k \in \mathbb{Z}\}$. 22. (a) $\left\{ \frac{\pi n}{3} - \frac{\pi}{12} \mid n \in \mathbb{Z} \right\}$,

except for $n=1+3m, m \in \mathbb{Z}$; (b) \emptyset ; (c) $\{\pi n | n \in \mathbb{Z}\}$. \blacktriangle The original equation is equivalent to the equation

$$2(\tan 3x - \tan 2x) = \tan 2x(1 + \tan 3x \tan 2x). \quad (1)$$

Now we seek the values of x for which $1 + \tan 3x \tan 2x = 0$. The last equation is equivalent to the equation $\cos x(\cos 2x \cos 3x) = 0$. It turns out that this equation has no solutions since if $\cos x = 0$, then $\cos 3x = 0$ as well. Consequently, equation (1) can be divided by $1 + \tan 3x \tan 2x \neq 0$; we have

$$2 \frac{\tan 3x - \tan 2x}{1 + \tan 3x \tan 2x} = \tan 2x, \quad \text{or} \quad 2 \tan x = \frac{2 \tan x}{1 - \tan^2 x}, \quad \text{or} \quad \tan x = 0,$$

Solving the equation $\tan x = 0$, we get $x = \pi n, n \in \mathbb{Z}$, and after verifying that the conditions $x \neq \pi k/2 + \pi/4$ and $x \neq \pi k/3 + \pi/6, k \in \mathbb{Z}$ are satisfied, we find that $x = \pi n, n \in \mathbb{Z}$, is a solution of the original equation; (d) $\{90^\circ n + 25^\circ | n \in \mathbb{Z}\}$. 23. (a) $\{2\pi n | n \in \mathbb{Z}\}$.

● Use the identity $\sin x = 2 \tan \frac{x}{2} / (1 + \tan^2 \frac{x}{2})$; (b) $\{2\pi n - \pi/2 | n \in \mathbb{Z}\}$. ● Use the identity $\cos x = (1 - \tan^2 \frac{x}{2}) / (1 + \tan^2 \frac{x}{2})$; (f) $\{\pi n \pm \pi/6; \pi/2 + \pi n | n \in \mathbb{Z}\}$; (d) $\{2\pi n \pm 2 \arctan 5 | n \in \mathbb{Z}\}$; (e) $\{2\pi n \pm 2 \arctan 3; 2\pi n \pm 2 \arctan \sqrt{3/11} | n \in \mathbb{Z}\}$; (f) $\{\pi n \pm \pi/4 | n \in \mathbb{Z}\}$. 24. No, they are not. \blacktriangle The sets of solutions of the first equation $\{\pi n - \pi/4; \pi n + \pi/2 | n \in \mathbb{Z}\}$ and of the second equation $\{\pi n - \pi/4 | n \in \mathbb{Z}\}$ do not coincide and, therefore, the equations are not equivalent. *Remark.* The identities

$$\sin \alpha = 2 \tan \frac{\alpha}{2} / \left(1 + \tan^2 \frac{\alpha}{2}\right) \quad \text{and} \quad \cos \alpha = 1 - \left(\tan^2 \frac{\alpha}{2}\right) / \left(1 + \tan^2 \frac{\alpha}{2}\right)$$

hold when $\cos \alpha \neq -1$. 25. (a) $\{\pi n + \pi/2; \pi n \pm \pi/3 | n \in \mathbb{Z}\}$. \blacktriangle Since $\cos 3x = 4 \cos^3 x - 3 \cos x$, the original equation is equivalent to the equation $\cos x(4 \cos^2 x - 1) = 0$, or $\cos x(\cos 2x + 1/2) = 0$, solving which we get the answer; (b) $\{\pi n/3 + \pi/6, 2\pi n/3 \pm 2\pi/9 | n \in \mathbb{Z}\}$. ● Reduce the equation to the form $\cos 3(3x) - 4 \cos^2 3x = 0$ and set $\cos 3x = t$; (c) $\{\pi n; \frac{\pi n}{2} \pm \frac{\pi}{12} | n \in \mathbb{Z}\}$. ● Reduce the equation to the form $2 \cos 2(2x) = 1 + \cos 3(2x)$ and set $\cos 2x = t$. 26. (a) $\{3\pi n | n \in \mathbb{Z}\}$.

● Use the identity $\sin x = 3 \sin \frac{x}{3} - 4 \sin^3 \frac{x}{3}$; (b) $\left\{\frac{\pi n}{2}; \frac{\pi n}{2} + (-1)^{n+1} \frac{\pi}{12} \mid n \in \mathbb{Z}\right\}$; (c) $\{2\pi n, 4\pi n \pm 2\pi/3 | n \in \mathbb{Z}\}$; (d) $\{\pi n + (-1)^n \pi/6; 2\pi n + \pi/2 | n \in \mathbb{Z}\}$. ● Use the identities $\sin\left(\frac{3}{4}\pi +$

$$+\frac{x}{2}) = \sin\left(\pi - \frac{3\pi}{4} - \frac{x}{2}\right) = \sin\left(\frac{\pi}{4} - \frac{x}{2}\right) \text{ and } \sin\left(\frac{x}{4} + \frac{3}{2}x\right) = \\ = \sin\left(\pi - \frac{\pi}{4} - \frac{3}{2}x\right) = \sin 3\left(\frac{\pi}{4} - \frac{x}{2}\right) \text{ and set } \frac{x}{2} - \frac{\pi}{4} = y.$$

27. $\{\pi n - \pi/4 | n \in \mathbb{Z}\}$. 28. (a) $\{2\pi n | n \in \mathbb{Z}\}$ for $\left\{2\pi n, 4\pi n \pm \pm 2 \arccos \frac{-1 \pm \sqrt{4a+5}}{4} \mid n \in \mathbb{Z}\right\}$ for $a \in [-5/4, 1]$, $\left\{2\pi n, 4\pi n \pm \pm 2 \arccos \frac{\sqrt{4a+5}-1}{4} \mid n \in \mathbb{Z}\right\}$ for $a \in (1; 5]$. \blacktriangle Factoring $\sin \frac{3x}{2}$ by the formula for the sine of a triple angle, we get an equation $\sin \frac{x}{2} \left(2 \cos \frac{x}{2} + 3 - 4 \sin^2 \frac{x}{2} - a\right) = 0$ or

$$\sin \frac{x}{2} \left(4 \cos^2 \frac{x}{2} + 2 \cos \frac{x}{2} - 1 - a\right) = 0. \quad (1)$$

Thus we have a collection of two equations:

$$\begin{cases} \sin \frac{x}{2} = 0, \\ 4 \cos^2 \frac{x}{2} + 2 \cos \frac{x}{2} - 1 - a = 0. \end{cases}$$

The equation $\sin(x/2) = 0$ has a solution $x = 2\pi n$, $n \in \mathbb{Z}$, for any $a \in \mathbb{R}$. Putting $\cos(x/2) = t$, we get a quadratic equation for t :

$$4t^2 + 2t - 1 - a = 0; \quad (2)$$

equation (2) can have solutions only for those values of $a \in \mathbb{R}$ for which $t \in [-1; 1]$. We seek the roots of equation (2): $t_1 = (-1 - \sqrt{4a+5})/4$; $t_2 = (-1 + \sqrt{4a+5})/4$. Then, solving the inequalities $-1 \leq t_1 < 0$ and $-1 \leq t_2 \leq 1$, we find that the root t_1 of equation (2) exists if $a \in [-5/4, 1]$, and t_2 if $a \in [-5/4; 5]$. Consequently, the equation $\cos(x/2) = t_1$ has solutions $x = 4\pi n \pm$

$\pm 2 \arccos \frac{-1 - \sqrt{4a+5}}{4}$, $n \in \mathbb{Z}$, for $a \in [-5/4; 1]$, and the equa-

tion $\cos \frac{x}{2} = t_2$ has solutions $x = 4\pi n \pm 2 \arccos \frac{\sqrt{4a+5}-1}{4}$, $n \in \mathbb{Z}$,

for $a \in [-5/4; 5]$. Taking into consideration that equation (2) has two solutions on the interval $[-5/4; 1]$, we get the answer;

(b) $\{\pi n | n \in \mathbb{Z}\}$ for $a \in (0, 1/3)$, $\left\{\pi n, \pi n \pm \frac{1}{2} \arccos \frac{1-a}{2a} \mid n \in \mathbb{Z}\right\}$

for $a \in (1/3; 1)$, $\left\{\pi n, \pi n \pm \frac{1}{2} \arccos \frac{1-a}{2a}; \pi n \pm \frac{1}{2} \arccos \times\right.$

$\times \left(-\frac{1+a}{2a}\right) \mid n \in \mathbb{Z}\}$ for $a \in [1; \infty)$. 29. $\left\{2\pi n \pm \arccos \frac{c}{\sqrt{a^2+b^2}} \pm\right.$

$+\arctan \frac{b}{a} \mid n \in \mathbb{Z} \}$ for $c^2 \leq a^2 + b^2$, \emptyset for $c^2 > a^2 + b^2$. \blacktriangle Since $a^2 + b^2 \neq 0$, we divide the equation by $\sqrt{a^2 + b^2}$ and get an equation

$$\frac{a}{\sqrt{a^2 + b^2}} \cos x + \frac{b}{\sqrt{a^2 + b^2}} \sin x = \frac{c}{\sqrt{a^2 + b^2}}, \quad (1)$$

equivalent to the original equation. The numbers $a/\sqrt{a^2 + b^2}$ and $b/\sqrt{a^2 + b^2}$ do not exceed unity in absolute value, and satisfy the identity $\left(\frac{a}{\sqrt{a^2 + b^2}}\right)^2 + \left(\frac{b}{\sqrt{a^2 + b^2}}\right)^2 = 1$. We can, therefore, put

$$a/\sqrt{a^2 + b^2} = \cos \varphi \text{ and } b/\sqrt{a^2 + b^2} = \sin \varphi.$$

Equation (1) now assumes the form

$$\cos x \cos \varphi + \sin x \sin \varphi = \cos(x - \varphi) = c/\sqrt{a^2 + b^2}. \quad (2)$$

Equation (2) has a solution if

$$|c/\sqrt{a^2 + b^2}| \leq 1 \text{ or } c^2 \leq a^2 + b^2.$$

Then we get

$$x - \varphi = 2\pi k \pm \arccos(c/\sqrt{a^2 + b^2}), \quad k \in \mathbb{Z}. \quad (3)$$

The value of the auxiliary argument φ can be found from the system of equations

$$\begin{cases} \cos \varphi = \frac{a}{\sqrt{a^2 + b^2}}, \\ \sin \varphi = \frac{b}{\sqrt{a^2 + b^2}}; \end{cases}$$

$\varphi = 2\pi m + \arctan \frac{b}{a}$, $m \in \mathbb{Z}$. (We assume here that $a > 0$; the case $a = 0$ reduces the original equation to the simplest equation $b \sin x = c$; now if $a < 0$, we can make the coefficient in $\cos x$ positive by multiplying the equation by -1 .) Substituting the value of φ we have obtained into equation (3), we find

$$x = 2\pi(m + k) \pm \arccos \frac{c}{\sqrt{a^2 + b^2}} + \arctan \frac{b}{a}$$

or

$$x = 2\pi n \pm \arccos \frac{c}{\sqrt{a^2 + b^2}} + \arctan \frac{b}{a}, \quad n \in \mathbb{Z},$$

since $(m + k) \in \mathbb{Z}$. *Remark.* If we suppose that $a/\sqrt{a^2 + b^2} = \sin \psi$, $b/\sqrt{a^2 + b^2} = \cos \psi$, then equation (2) assumes the form $\sin(x + \psi) = c/\sqrt{a^2 + b^2}$. 30. $[\sqrt{5} - 1; 2]$. 31. (a) $\left\{ 2\pi n \pm \arccos \frac{2}{\sqrt{13}} + \right.$

$+\arctan \frac{3}{2} \mid n \in \mathbb{Z}$, (b) $\left\{ 2\pi n \pm \arccos \frac{a^2}{\sqrt{2}} + \frac{\pi}{4} \mid n \in \mathbb{Z} \right\}$ for $a \in$
 $\in [-\sqrt[4]{2}; \sqrt[4]{2}]$, \emptyset for $a \in (-\infty; -\sqrt[4]{2}) \cup (\sqrt[4]{2}; \infty)$; (c) $\left\{ \pi n \pm \frac{1}{2} \times \right.$
 $\times \arccos \frac{a}{\sqrt{10}} + \frac{1}{2} \arctan \frac{1}{3} \mid n \in \mathbb{Z} \left. \right\}$ for $a \in [-\sqrt{10}; \sqrt{10}]$, \emptyset
for $a \in (-\infty; -\sqrt{10}) \cup (\sqrt{10}; \infty)$. \blacktriangle Dividing the given equation
by $\sqrt{1^2+3^2}=\sqrt{10}$ and setting $3/\sqrt{10}=\cos \varphi$; $1/\sqrt{10}=\sin \varphi$, we
obtain $\cos 2x \cos \varphi + \sin 2x \sin \varphi = \cos (2x - \varphi) = a/\sqrt{10}$, where $\varphi =$
 $=\arctan (1/3)$. The equation $\cos (2x - \varphi) = a/\sqrt{10}$ has a solution if
 $|a/\sqrt{10}| \leq 1$ or $-\sqrt{10} \leq a \leq \sqrt{10}$. Thus we have $2x - \arctan \frac{1}{3} =$
 $= 2\pi n \pm \arccos \frac{a}{\sqrt{10}}$, $n \in \mathbb{Z}$, for $|a| \leq \sqrt{10}$. Hence we find the
answer; (d) $\left\{ \frac{\pi n}{6} \pm \frac{1}{12} \arccos \frac{2a+17}{\sqrt{137}} + \frac{1}{12} \arctan \frac{4}{11} \mid n \in \mathbb{Z} \right\}$
for $a \in \left[\frac{-\sqrt{137}-17}{2}; \frac{\sqrt{137}-17}{2} \right]$, \emptyset for $a \in (-\infty;$
 $\frac{-\sqrt{137}-17}{2}) \cup (\frac{\sqrt{137}-17}{2}; \infty)$. \bullet Make use of the formu-
las $\sin^2 6x = \frac{1 - \cos 12x}{2}$, $\cos^2 6x = \frac{1 + \cos 12x}{2}$, $\sin 6x \cos 6x =$
 $= \frac{1}{2} \sin 12x$. 32. $\left\{ \frac{2\pi n}{3} \pm \frac{1}{3} \arccos \frac{a}{5} - \frac{1}{3} \arctan \frac{4}{3} \mid n \in \mathbb{Z} \right\}$ for
 $a \in [-5; 5]$; for $a \notin [-5; 5]$ the function has no critical points.
33. (a) $\left\{ \pi n - \frac{\pi}{8} \mid n \in \mathbb{Z} \right\}$; (b) $\left\{ \pi n, \frac{\pi n}{3} + \frac{\pi}{6} \mid n \in \mathbb{Z} \right\}$; (c) $\left\{ \frac{4\pi n}{5} + \right.$
 $+\frac{2\pi}{5}; \frac{4\pi n}{3} + \frac{2}{3} \pi \mid n \in \mathbb{Z} \left. \right\}$; (d) $\left\{ \frac{\pi n}{4} \mid n \in \mathbb{Z} \right\}$; (e) $\left\{ \frac{\pi n}{2} + \frac{\pi}{8}; \right.$
 $\pi n + \frac{3\pi}{4} \mid n \in \mathbb{Z} \left. \right\}$. \bullet Reduce the equation to the form $\cos 3x +$
 $+\cos \left(\frac{\pi}{2} + x \right) = 0$; (f) $\{n; (-1 \pm \sqrt{4l+3})/2 \mid n \in \mathbb{Z}, l \in \mathbb{Z}_0\}$.
34. (a) $\{\pi n + \pi/4 \mid n \in \mathbb{Z}\}$; (b) $\{\pi n/4 \mid n \in \mathbb{Z}\}$; (c) $\left\{ \frac{\pi n}{6} + \frac{\pi}{12}; 2\pi n \pm \right.$
 $\pm \frac{2\pi}{3} \mid n \in \mathbb{Z} \left. \right\}$; (d) $\{\pi n; 2\pi n \pm \pi/6 \mid n \in \mathbb{Z}\}$; (e) $\{\pi n - \pi/4; \pi n +$
 $+\pi/2 \mid n \in \mathbb{Z}\}$; (f) $\left\{ \frac{2\pi n}{3}; \pi n + \pi/4; 2\pi n - \pi/2 \mid n \in \mathbb{Z} \right\}$; (g) $\{\pi n/2 \mid n \in \mathbb{Z}\}$;
(h) $\{\pi n + \pi/2 \mid n \in \mathbb{Z}\}$. 35. (a) $\left\{ \frac{\pi n}{6} + \frac{\pi}{48}; \frac{\pi n}{4} + \frac{3\pi}{32} \mid n \in \mathbb{Z} \right\}$.
 \bullet Reduce the equation to the form $\sin 10x = \sin (\pi/4 - 2x)$;

(b) $\{x_0 | x_0 \in \mathbb{R}, \text{ except for } x_0 = \pi n, n \in \mathbb{Z}\}$; (c) $\{\pi n/5; \pi n \pm 3\pi/8 | n \in \mathbb{Z}\}$.

● Reduce the equation to the form $\frac{\sin 2x \cos 3x + \sin 3x \cos 2x}{\cos 2x} + \sqrt{2} \sin 5x = 0$; (d) $\left\{4\pi n + \frac{17}{6}\pi; \frac{8\pi n}{3} - \frac{5\pi}{18}; \frac{8\pi n}{3} + \frac{\pi}{6} \mid n \in \mathbb{Z}\right\}$.

● Reduce the right-hand side of the equation to the form $2\sqrt{3} \cos\left(\frac{x}{4} + \frac{\pi}{8} - \frac{\pi}{3}\right) = 2\sqrt{3} \cos\left(\frac{x}{4} - \frac{5\pi}{24}\right)$.

36. (a) $\{2\pi n/5, \pi n + \pi/2; 2\pi n + \pi | n \in \mathbb{Z}\}$.

● Reduce the equation to the form $(\sin x + \sin 4x) + (\sin 2x + \sin 3x) = 2 \sin \frac{5}{2}x \left(\cos \frac{3}{2}x + \cos \frac{x}{2}\right) = 0$; (b) $\left\{\frac{\pi n}{5}; \frac{\pi n}{3} + \frac{\pi}{6} \mid n \in \mathbb{Z}\right\}$; (c) $\left\{\pi n + \frac{\pi}{2}; \frac{\pi n}{6} + \frac{\pi}{24} \mid n \in \mathbb{Z}\right\}$; (d) $\left\{\frac{\pi n}{4} + \frac{\pi}{8}; \frac{\pi n}{3} + (-1)^{n+1} \frac{\pi}{18} \mid n \in \mathbb{Z}\right\}$; (e) $\left\{\frac{\pi n}{5} + (-1)^n \frac{\pi}{30}; \frac{\pi n}{4} + \frac{\pi}{16}; \pi n + \frac{3\pi}{4} \mid n \in \mathbb{Z}\right\}$; (f) $\{\pi n + \pi/2, \pi n + (-1)^n \pi/6; 2\pi n \pm 2\pi/3 | n \in \mathbb{Z}\}$;

(g) $\{\pi n/2; 2\pi n \pm 2\pi/3 | n \in \mathbb{Z}\}$; (h) $\left\{\frac{\pi}{7}(2n+1) \mid n \in \mathbb{Z}, \text{ except for } n = 7l - 4, l \in \mathbb{Z}\right\}$. ▲ We transform the equation:

$$\frac{1}{\sin x} = \frac{1}{\sin 2x} + \frac{1}{\sin 4x} = \frac{2 \sin 3x \cos x}{2 \sin x \cos x \sin 4x},$$

$$\sin 4x - \sin 3x = 0; 2 \sin \frac{x}{2} \cos \frac{7}{2}x = 0.$$

From the solutions of the last equation we must choose those for which $\sin x \neq 0$, $\sin 2x \neq 0$, $\sin 4x \neq 0$. We have: $\sin(x/2) = 0$, $x = 2\pi k$, $k \in \mathbb{Z}$ is an extraneous solution, the denominators of all fractions of the original equation turn into zero; next we have

$$\cos(7x/2) = 0, \quad x = \pi(2n+1)/7.$$

We exclude from this solution the values of n for which $x = \pi m/4$ (this is sufficient, since all solutions of the equations $\sin x = 0$, $\sin 2x = 0$ are solutions of the equation $\sin 4x = 0$). We have an equation $\pi(2n+1)/7 = \pi m/4$ or $7m = 8n+4$; $m = n + (n+4)/7$. Thus, if $(n+4)/7 = l$, $l \in \mathbb{Z}$, then there are integral m for which the equation becomes meaningless. We finally have $x = \pi(2n+1)/7$, $n \in \mathbb{Z}$, except for $n = 7l - 4$, $l \in \mathbb{Z}$; (i) $(-\infty; \infty)$

for $a \in \{k\pi | k \in \mathbb{Z}\}, \left\{2\pi n \pm \arccos \frac{1 \pm \sqrt{5}}{4} \mid n \in \mathbb{Z}\right\}$ for $a \in (-\infty; \infty)$.

37. $\{\pi n/4 + \pi/8; \pi n \pm \pi/3 | n \in \mathbb{Z}\}$. 38. (a) $\{\pi n | n \in \mathbb{Z}\}$; (b) $\left\{\frac{\pi n}{3} \mid n \in \mathbb{Z}\right\}$.

$$\begin{aligned} \blacktriangle \left(\frac{\sin x}{\cos x} - \frac{\sin 3x}{\cos 3x} \right) + \frac{\sin 2x}{\cos 2x} &= \frac{\sin 2x}{\cos 2x} - \frac{\sin 2x}{\cos x \cos 3x} \\ &= \frac{\sin 2x (\cos x \cos 3x - \cos 2x)}{\cos x \cos 2x \cos 3x} = -\tan x \tan 2x \tan 3x = 0. \end{aligned}$$

Solving the equation, we find that $x_1 = \pi n$, $n \in \mathbb{Z}$; $x_2 = \frac{\pi m}{2}$, $m \in \mathbb{Z}$,

and $x_3 = \pi l/3$, $l \in \mathbb{Z}$. The equation $x = \pi l/3$ is a consequence of the equation $x = \pi n$ and the equation $x = \pi m/2$ (for $m = 2p$, $p \in \mathbb{Z}$). The odd values of m yield extraneous solutions. Thus we have $x = \pi n/3$, $n \in \mathbb{Z}$. 39. (a) $\{\pi n/10 \mid n \in \mathbb{Z}\}$. \blacktriangle The original equation is equivalent to the equation $(\cos 3x + \cos 9x)/2 = (\cos 3x + \cos 11x)/2$ or $\cos 9x - \cos 11x = 0$. Transforming the difference of the cosines of two angles into a product, we get an equation $2 \sin x \sin 10x = 0$, which yields solutions $x = \pi k$, $x = \pi n/10$, $k, n \in \mathbb{Z}$. Taking into account that the solutions of the first equation are also solutions of the second (for $k = 10n$), we get the answer;

$$(b) \left\{ \frac{\pi n}{3} + \frac{\pi}{6}; \frac{\pi n}{5} + \frac{\pi}{10} \mid n \in \mathbb{Z} \right\}; \quad (c) \{ \pi n; \pi n/5 + \pi/10 \mid n \in \mathbb{Z} \};$$

$$(d) \left\{ \pi n; \frac{\pi n}{3} + \frac{\pi}{6} \mid n \in \mathbb{Z} \right\}; \quad (e) \left\{ n - \frac{5}{12}; n + \frac{1}{4} \mid n \in \mathbb{Z} \right\}.$$

$$40. (a) \left\{ \frac{\pi n}{2}; \pi n \pm \frac{\pi}{6} \mid n \in \mathbb{Z} \right\}. \quad \blacktriangle$$

Multiplying the given equation by 2 and applying the identity $1 - \cos \alpha = 2 \sin^2 \frac{\alpha}{2}$, we reduce

the equation to the form $2 \sin^2 2x - (\cos 2x - \cos 6x) = 0$. Transforming then the difference of the cosines into a product of sines, we obtain: $2 \sin^2 2x - 2 \sin 2x \sin 4x = 0$, $\sin^2 2x (1 - 2 \cos 2x) = 0$. From the last equation we get x : $x = \pi n/2$ and $x = \pi n \pm \pi/6$, $n \in \mathbb{Z}$;

$$(b) \left\{ \frac{\pi n}{2} + \frac{\pi}{4}; \frac{\pi n}{5} + \frac{\pi}{10} \mid n \in \mathbb{Z} \right\}; \quad (c) \left\{ \pi n + \frac{\pi}{2}; \frac{2\pi n}{11} + \frac{\pi}{11}; \frac{2\pi n}{5} \mid n \in \mathbb{Z} \right\}; \quad (d) \left\{ \pi n \pm \frac{1}{2} \arccos \frac{3}{4} \mid n \in \mathbb{Z} \right\}. \quad 41. (a) \left\{ \frac{2\pi n}{7} + \frac{\pi}{7} \mid n \in \mathbb{Z} \right\}. \quad \bullet$$

Reduce the equation to the form

$$2 \sin \frac{x}{2} \sin x + 2 \sin \frac{x}{2} \sin 2x + 2 \sin \frac{x}{2} \sin 3x = \cos \frac{x}{2}$$

and transform the left-hand part using the formula $2 \sin \alpha \sin \beta = \cos(\alpha - \beta) - \cos(\alpha + \beta)$; (b) $\{2\pi n/7 \mid n \in \mathbb{Z}, \text{ except for } n = 7k, k \in \mathbb{Z}\}$. \bullet Multiply the equation by $2 \sin \frac{x}{2}$.

$$42. (a) \left\{ \frac{\pi n}{4} + (-1)^{n+1} \frac{\pi}{24} \mid n \in \mathbb{Z} \right\}. \quad \blacktriangle$$

The original equation is equivalent to the equation

$$\sin x \cos 3x (1 - \cos 2x) + \cos x \sin 3x (1 + \cos 2x) = -3/4, \quad \text{or} \\ (\sin x \cos 3x + \cos x \sin 3x) + \cos 2x (\sin 3x \cos x - \cos 3x \sin x) = -3/4 \quad \text{or} \quad \sin 4x + (\sin 4x)/2 = -3/4. \quad \text{Now we get an equation} \\ \sin 4x = -1/2, \quad \text{whose solution yields the answer; (b) } \{ \pi n \pm \pi/8 \mid n \in \mathbb{Z} \}.$$

$$43. (a) \left\{ \frac{\pi n}{3} + (-1)^n \frac{\pi}{18} \mid n \in \mathbb{Z} \right\}. \quad \blacktriangle$$

We decompose the left-hand

side of the equation into a sum of trigonometric functions:

$$\begin{aligned} \frac{1}{2} \sin x \left(2 \sin \left(\frac{\pi}{3} - x \right) \sin \left(\frac{\pi}{3} + x \right) \right) &= \frac{1}{2} \sin x \left(\cos 2x - \cos \frac{2\pi}{3} \right) \\ &= \frac{1}{4} (2 \sin x \cos 2x + \sin x) = \frac{1}{4} (\sin 3x - \sin x + \sin x) = \frac{\sin 3x}{4}. \end{aligned}$$

Solving now the equation $\sin 3x = \frac{1}{8} \cdot 4 = \frac{1}{2}$, we get the answer;

(b) $\{2\pi n/3 \pm 2\pi/9 | n \in \mathbb{Z}\}$; (c) $\{\pi n/3 - \pi/9 | n \in \mathbb{Z}\}$. 44. (a) $\{\pi n; \pi n \pm \pi/6 | n \in \mathbb{Z}\}$; (b) $\{\pi n, \pi n \pm \pi/6 | n \in \mathbb{Z}\}$; (c) $\left\{ \pi n \pm \frac{1}{2} \times \right.$

$\times \arccos \left(-\frac{5}{6} \right) \left| n \in \mathbb{Z} \right\}$. • Reduce the given equation to the form

$$\frac{\sin x \cos 3x - \cos x \sin 3x}{\cos x \sin 3x} = 3; \text{ (d) } \left\{ \pi n \pm \frac{1}{2} \arccos \left(-\frac{1}{4} \right); \pi n \pm \right.$$

$\left. \pm \frac{1}{2} \arccos \frac{1}{3} \right| n \in \mathbb{Z} \left. \right\}$; (e) $\{\pi n + \pi/2 | n \in \mathbb{Z}\}$. 45. (a) $\{\pi n \pm \pi/8 | n \in \mathbb{Z}\}$; (b) $\{\pi n \pm \pi/6 | n \in \mathbb{Z}\}$; (c) $\{\pi n/2 + \pi/4; \pi n + \pi/2 | n \in \mathbb{Z}\}$.

• $8 \sin^6 x = (1 - \cos 2x)^3$, (d) $\left\{ \frac{\pi n}{2} + \frac{\pi}{4}; \pi n \pm \frac{1}{2} \times \right.$

$\times \arccos \frac{\sqrt{5}-1}{2} \left| n \in \mathbb{Z} \right\}$. • Apply the formulas $\tan^2 x =$

$$= (1 - \cos 2x)/(1 + \cos 2x), \quad \cos 4x = 2 \cos^2 2x - 1; \text{ (e) } \left\{ \pi n + \frac{\pi}{4}; \right.$$

$\left. \frac{\pi n}{2} + \frac{(-1)^n}{2} \arcsin \frac{\sqrt{5}-1}{2} \right| n \in \mathbb{Z} \left. \right\}$. 46. (a) $\left\{ \pi n \pm \frac{1}{2} \times \right.$

$\times \arccos (3 - 2\sqrt{3-a^2}) \left| n \in \mathbb{Z} \right\}$, $a \in [-\sqrt{2}; \sqrt{2}]$, \emptyset for $a \notin$

$\notin [-\sqrt{2}; \sqrt{2}]$; (b) $\left\{ \frac{\pi n}{2} \pm \frac{1}{4} \arccos \frac{7}{16a-1} \left| n \in \mathbb{Z} \right\}$ for

$a \in \left(-\infty, -\frac{3}{8} \right] \cup \left[\frac{1}{2}; \infty \right)$, \emptyset for $a \in (-3/8, 1/2)$; (c) $\{\pi n/2 +$

$+\pi/4 | n \in \mathbb{Z}\}$ for $a \in (-\infty; 6] \cup (8; +\infty)$; $\left\{ \frac{\pi n}{2} + \frac{\pi}{4}; \frac{\pi n}{2} \pm \frac{1}{4} \times \right.$

$\times \arccos (a-7) | n \in \mathbb{Z} \left. \right\}$ for $a \in (6; \infty]$. 47. (a) $\{\pi(4n+1)/2;$

$\pi(2n+1) | n \in \mathbb{Z}\}$. • Setting $\sin x - \cos x = y$, we find $(\sin x -$

$-\cos x)^2 = 1 - \sin 2x = y^2$ or $\sin 2x = 1 - y^2$. The original equation assumes the form $y^2 + 12y - 13 = 0 \Rightarrow y_1 = 1, y_2 = -13$.

We thus get two equations: $\sin x - \cos x = y_1 = 1$, whose solutions are $x_1 = \pi(2n+1), x_2 = \pi(4n+1)/2, n \in \mathbb{Z}$, and $\sin x - \cos x =$

$= y_2 = -13$, which has no solutions; (b) $\left\{ \pi n - \frac{\pi}{4}; \frac{\pi n}{2} + (-1)^{n+1} \frac{\pi}{8} \right.$

$|n \in \mathbb{Z}\rangle$. ● Reduce the equation to the form $1/\sin x + 1/\cos x = -2/\sqrt{2}(\sin x + \cos x)$ and set $\sin x + \cos x = y$;
(c) $\{2\pi n + \frac{\pi}{4}; 2\pi n + \frac{11}{12}\pi; 2\pi n - \frac{5}{12}\pi | n \in \mathbb{Z}\}$; (d) $\{2\pi n; 2\pi n + \pi/2 | n \in \mathbb{Z}\}$; (e) $\{2\pi n - \frac{\pi}{2}; \pi n - \frac{\pi}{4} + (-1)^n \arcsin(\frac{1}{\sqrt{2}} - 1) | n \in \mathbb{Z}\}$. ● Reduce the given equation to the form $\sin x(1 + \sin x) + \cos x(1 - \sin^2 x) = (1 + \sin x)(\sin x + \cos x - \sin x \cdot \cos x) = 0$; (f) $\{(4\pi n + \pi/2)^2; (4\pi n + 11\pi/6)^2 | n \in \mathbb{Z}_0; (4\pi m - 5\pi/6)^2 | m \in \mathbb{N}\}$. 48. (a) $\{2\pi n | n \in \mathbb{Z}\}$ for $a \in \{-1\} \cup (-2(\sqrt{2}-1); 2(\sqrt{2}+1))$, $\{2\pi n; 2\pi n \pm (\pi - \arccos \frac{a+2}{a\sqrt{2}}) + \frac{\pi}{4} | n \in \mathbb{Z}\}$ for $a \in (-\infty; -1) \cup (-1; -2(\sqrt{2}-1)] \cup [2(\sqrt{2}+1); \infty)$; (b) $\{2\pi n - \pi/4 | n \in \mathbb{Z}\}$ for $b \in (-\infty; 0) \cup (1; \infty)$, $\{2\pi n - \pi/4; 2\pi n \pm \arccos(2b-1) - \pi/4 | n \in \mathbb{Z}\}$ for $b \in [0; 1]$; (c) $\{\pi n - \pi/4 | n \in \mathbb{Z}\}$ for $a \in (-\infty; -3/\sqrt{2}) \cup (-1/\sqrt{2}; \infty)$, $\{\pi n - \frac{\pi}{4}; \frac{\pi n}{2} + \frac{(-1)^n}{2} \times \arcsin(a\sqrt{2}+2) | n \in \mathbb{Z}\}$ for $a \in [-\frac{3}{\sqrt{2}}; -\frac{1}{\sqrt{2}}]$. 49. $\{2\pi n; 2\pi n + \pi/2 | n \in \mathbb{Z}\}$. 50. (a) $\{2\pi n + 5\pi/6 | n \in \mathbb{Z}\}$. ▲ We solve the original equation for $\tan x$ ($\sin x$ is assumed to be the parameter)

$$\tan x = \left(-\frac{2}{\sqrt{3}} \pm \sqrt{-2\left(\sin x - \frac{1}{2}\right)^2} \right) / 2. \quad (1)$$

The equation obtained has solutions if $\sin x = 1/2$; then $\tan x = -1/\sqrt{3}$ and we arrive at a system of equations

$$\begin{cases} \sin x = 1/2. \\ \tan x = -\frac{1}{\sqrt{3}}. \end{cases}$$

From the first equation of the system we have $x_1 = 2\pi n + \pi/6$ and $x_2 = 2\pi n + 5\pi/6$, $n \in \mathbb{Z}$. The second equation is satisfied only by the values of x_2 ; (b) $\{2\pi n; 2\pi n + \pi/2 | n \in \mathbb{Z}\}$; (c) $\{2\pi n - \pi/4 | n \in \mathbb{Z}\}$. ● Reduce the equation to the form $\cos^2 2x + \sin^4(x/2 + \pi/8) = 0$ and then solve the system of equations

$$\begin{cases} \cos 2x = 0. \\ \sin(x/2 + \pi/8) = 0. \end{cases}$$

51. (a) $\{2\pi(1+4n) | n \in \mathbb{Z}\}$. ▲ Simple transformations reduce the equation to the form

$$\sin \frac{5x}{4} + \cos x = 2. \quad (1)$$

Since $\sin(5x/4) \leq 1$, $\cos x \leq 1$, for equation (1) to hold it is necessary that the equations $\cos x = 1$ and $\sin(5x/4) = 1$ hold simultaneously. Thus we have a system of equations

$$\begin{cases} x = 2\pi k, \\ 5x/4 = \pi/2 + 2\pi l, \end{cases}$$

where k, l are some integers. Excluding x from the system, we arrive at an equation $4l = 5k - 1$, or $l = k + \frac{k-1}{4}$. The last equation has an integer solution if $(k-1)/4 = n$, $n \in \mathbb{Z}$. We finally get: $k = 4n + 1$, $n \in \mathbb{Z}$, and $x = 2\pi(4n + 1)$; (b) $\{\pi n/3; 2\pi n - \pi/2 \mid n \in \mathbb{Z}\}$.

52. (a) $\left\{ \pi n - \arctan \frac{1}{6}; \pi n - \arctan \frac{1}{3} \mid n \in \mathbb{Z} \right\}$. $\bullet \sqrt{\frac{1}{\cos^2 x} - 1} = |\tan x|$; (b) $\bigcup_{n \in \mathbb{Z}} \left[2\pi n - \frac{\pi}{3}; 2\pi n + \frac{2\pi}{3} \right]$.

$\bullet \sqrt{2 + \cos 2x + \sqrt{3} \sin 2x} = 2|\cos(x - \pi/6)|$. 53. (a) $\{\pi n \pm \pi/6 \mid n \in \mathbb{Z}\}$.

\blacktriangle Only those values of x can be solutions of the given equation for which $\cos 2x > -1/4$. Squaring the equation and performing transformations, we get an equation $8 \cos^2 2x + 10 \cos 2x - 7 = 0$, which yields: $\cos 2x = -7/4$ and $\cos 2x = 1/2$. The equation $\cos 2x = -7/4$ has no solutions, and the solution of the second equation is a solution of the original equation ($\cos 2x = 1/2 > -1/4$); (b) $\{2\pi n + \arctan a \mid n \in \mathbb{Z}\}$ for $a \in (0; \infty)$ $\{\pi(2n + 1) + \arctan a \mid n \in \mathbb{Z}\}$

for $a \in (-\infty; 0)$, $\{\pi n \mid n \in \mathbb{Z}\}$ for $a = 0$. 54. (a) $\left\{ 2\pi n + \frac{3}{4}\pi \mid n \in \mathbb{Z} \right\}$.

\blacktriangle The original equation is equivalent to the system $\begin{cases} \sin x = \sqrt{2} \cos^2 x, \\ \cos x \leq 0. \end{cases}$

Solving the equation $\sqrt{2} \sin^2 x + \sin x - \sqrt{2} = 0$ of the system, we arrive at an equation $\sin x = 1/\sqrt{2}$. The solutions of the last equation are $x = 2\pi n + \pi/4$ (which is extraneous since the inequality of the system is not satisfied) and $x = 2\pi n + 3\pi/4$, $n \in \mathbb{Z}$, satisfying all the conditions of the system;

(b) $\left\{ 2\pi n \arccos \frac{\sqrt{5}-1}{2} \mid n \in \mathbb{Z} \right\}$; (c) $\{2\pi n + \pi/8; 2\pi n - 3\pi/8 \mid n \in \mathbb{Z}\}$;

(d) $\{\pi n/2; \pi n + \pi/6 \mid n \in \mathbb{Z}\}$; (e) $\{2\pi n + \pi/2; 2\pi n - \pi/6 \mid n \in \mathbb{Z}\}$;

(f) $(-\infty; \infty)$ for $a = 0$; $\{\pi n \mid n \in \mathbb{Z}\}$ for $a \in (-\infty; \infty)$. 55. (a) $\{2\pi n; 2\pi n - \pi/2 \mid n \in \mathbb{Z}\}$; (b) $\{2\pi n + 3\pi/8; 2\pi n + 7\pi/8; 2\pi n + \pi; \pi n + \pi/4 \mid n \in \mathbb{Z}\}$. \bullet Reduce the equation to the form $(\sin 2x + \cos 2x)(1 - \cos 2x - \sin 2x) = 0$ and take into consideration the condition $\sin x - \cos x \geq 0$;

(c) $\{2\pi n; \pi n - \pi/4 \mid n \in \mathbb{Z}\}$; (d) $\left\{ \frac{\pi n}{3} + (-1)^{n+1} \frac{\pi}{18} \mid n \in \mathbb{Z} \right\}$;

(e) $\left\{ \pi n + \arctan \frac{2}{3} \mid n \in \mathbb{Z} \right\}$; (f) $\left\{ 2\pi n + \frac{\pi}{12}; 2\pi n - \frac{7\pi}{12} \mid n \in \mathbb{Z} \right\}$.

56. (a) $\{2\pi n + \frac{\pi}{6}; \frac{2}{3}\pi l + \frac{5}{18}\pi \mid n, l \in \mathbb{Z}, \text{ except for } l=3m+2, m \in \mathbb{Z}\}$; (b) $\{4\pi n + \frac{13}{6}\pi \mid n \in \mathbb{Z}\}$. 57. $\{2\pi n \pm \arccos(\frac{1}{2} + \frac{1}{4} \times (a - \frac{5}{6a})^2) \mid n \in \mathbb{Z}\}$ for $a \in [\sqrt{\frac{5}{6}}; \frac{2\sqrt{2} + \sqrt{3}}{\sqrt{6}}]$, \emptyset for $a \notin [\sqrt{5/6}; (2\sqrt{2} + \sqrt{3})/\sqrt{6}]$. 58. (a) $\{2\pi n + \arccos(1/3) \mid n \in \mathbb{Z}\}$. **▲** Having transformed the right-hand part of the equation

$$(\log_5 4) \log_4 (3 \sin x) = \frac{\log_4 (3 \sin x)}{\log_4 5} = \log_5 (3 \sin x),$$

we get an equation $\log_5 \tan x = \log_5 3 \sin x$, which is equivalent to the system $\begin{cases} \tan x = 3 \sin x, \\ \sin x > 0. \end{cases}$ Solving the equation of the system, we obtain $\cos x = 1/3$ ($\sin x \neq 0$), whence we find that $x_1 = 2\pi n + \arccos(1/3)$ and $x_2 = 2\pi n - \arccos(1/3)$, $n \in \mathbb{Z}$. The second solution (x_2) does not satisfy the inequality of the system; (b) $\{2\pi n + \arccos \frac{1}{10} \mid n \in \mathbb{Z}\}$. 59. (a) $\{\pi n \mid n \in \mathbb{Z}\}$.

● Reduce the equation to the form $2^{2 \cos^2 x - 1} = 3 \cdot 2^{\cos^2 x} - 4$ and set $2^{\cos^2 x} = t$; (b) $\{\log_2(\pi n/4 + \pi/8) \mid n \in \mathbb{Z}_0\}$; (c) $\{1; \frac{7}{12}\pi; \pi n - \frac{\pi}{12}; \pi n + \frac{7}{12}\pi \mid n \in \mathbb{N}\}$. 60. (a) $\{(2\pi n \pm \arccos \frac{\sqrt{57}-6}{3} + \frac{13\pi}{2}; 2\pi n \pm \arccos \frac{\sqrt{57}-6}{3}) \mid n \in \mathbb{Z}\}$; (b) $\{(\pi n + \frac{\pi}{2}; \frac{\pi}{6} - \pi n) \mid n \in \mathbb{Z}\}$; (c) $\{(2\pi n \pm \arccos \frac{a}{2 \cos(\pi/8)} + \frac{\pi}{8}; \frac{\pi}{8} - 2\pi n \mp \arccos \frac{a}{2 \cos(\pi/8)}) \mid n \in \mathbb{Z}\}$ for $a \in [-2 \cos \frac{\pi}{8}; 2 \cos \frac{\pi}{8}]$, \emptyset for $a \in (-\infty; -2 \cos \frac{\pi}{8}) \cup (2 \cos \frac{\pi}{8}; \infty)$. 61. (a) $\{(\frac{\pi}{5} \times (n+4k) \pm \frac{2\pi}{15} + \frac{(-1)^n}{5} \arcsin 2a; \frac{\pi}{5}(n-6k) \mp \frac{\pi}{5} + \frac{(-1)^n}{5} \times \arcsin 2a) \mid n, k \in \mathbb{Z}\}$ for $a \in (-\infty; 0]$, \emptyset for $a \in (0; \infty)$; (b) $\{(\pi(n + \frac{k}{2}) + \frac{\pi}{6}; \pi(\frac{k}{2} - n) + \frac{\pi}{3}); (\pi(\frac{k}{2} + n) + \frac{\pi}{3}; \pi(\frac{k}{2} - n) + \frac{\pi}{6}) \mid k, n \in \mathbb{Z}\}$; (c) $\{(\frac{\pi}{4} + \pi m; \pi(2n - m) + \frac{\pi}{4}) \mid m, n \in \mathbb{Z}\}$; (d) $\{(2\pi n + \frac{\pi}{6}; 2\pi k + \frac{\pi}{3}); (2\pi n + \frac{7\pi}{6};$

$$\begin{aligned}
& \left. 2\pi k + \frac{4\pi}{3} \right); \quad \left(2\pi n - \frac{\pi}{6}; 2\pi k + \frac{2\pi}{3} \right); \quad \left(2\pi n + \frac{5\pi}{6}; 2\pi k + \right. \\
& \left. + \frac{5\pi}{3} \right) \Big| n, k \in \mathbb{Z} \}. \quad 62. \text{ (a) } \{ (\pi n - \pi/4; \pi m + (-1)^m \pi/6) \mid n, m \in \mathbb{Z} \}; \\
& \text{(b) } \{ (2\pi n \pm 3\pi/4; \pi m + (-1)^m \pi/6) \mid n, m \in \mathbb{Z} \}; \quad \text{(c) } \left\{ \left(2\pi n + \frac{\pi}{2}; \right. \right. \\
& \left. \left. 2\pi k \pm \arccos \left(\frac{-a}{3} \right) \right) \Big| n, k \in \mathbb{Z} \right\} \text{ for } a \in (-3; 3], \{ (2\pi n + \pi/2; \\
& 2\pi k); (2\pi n - \pi/2; \pi(2k+1)) \mid n, k \in \mathbb{Z} \} \text{ for } a = -3, \emptyset \text{ for } a \in (-\infty; \\
& -3) \cup (3; \infty); \quad \text{(d) } \left\{ \left(2\pi n \pm \arccos \frac{1}{a}; \pi k - \arctan(a+2) \right); \right. \\
& \left. \left(2\pi n \pm \arccos \frac{1}{a+2}; \pi k - \arctan a \right) \Big| n, k \in \mathbb{Z} \right\} \text{ for } a \in (-\infty; \\
& -3] \cup [4; \infty), \left\{ \left(2\pi n \pm \arccos \frac{1}{a}; \pi k - \arctan(a+2) \right) \Big| n, k \in \mathbb{Z} \right\} \\
& \text{for } a \in (-3; -1], \left\{ \left(2\pi n \pm \arccos \frac{1}{a+2}; \pi k - \arctan a \right) \Big| n, k \in \mathbb{Z} \right\} \\
& \text{for } a \in (-4; 1). \quad 63. \quad \left\{ \left(\frac{\pi k}{2} + (-1)^{k+1} \frac{\pi}{8}; \frac{\pi n}{5} - \frac{1}{5} \times \right. \right. \\
& \left. \left. \times \arctan \frac{1}{\sqrt{2}} \right) \Big| n, k \in \mathbb{Z} \right\}.
\end{aligned}$$

2.8. Trigonometric Inequalities

1. (a) $(\pi n; \pi n + \pi/2)$, $n \in \mathbb{Z}$;
- (b) $(4\pi n + 2\pi; 4\pi n + 4\pi)$, $n \in \mathbb{Z}$;
- (c) $\left[2\pi n + \frac{7}{12}\pi; 2\pi n + \frac{23}{12}\pi \right]$, $n \in \mathbb{Z}$;
- (d) $(\pi n - \pi/8 + 1/2; \pi n + 5\pi/8 + 1/2)$, $n \in \mathbb{Z}$;
- (e) $\{-\pi/2 + 2\pi n \mid n \in \mathbb{Z}\}$.
2. (a) $(6\pi n - 3\pi/2; 6\pi n + 3\pi/2)$, $n \in \mathbb{Z}$;
- (b) $(\pi n/2 + \pi/8; \pi n/2 + 3\pi/8)$, $n \in \mathbb{Z}$;
- (c) $[2\pi n - \pi/6; 2\pi n + \pi/2]$, $n \in \mathbb{Z}$;
- (d) $(4\pi n + 3\pi/2 - 1/2; 4\pi n + 5\pi/2 - 1/2)$, $n \in \mathbb{Z}$;
- (e) $\{2\pi n \mid n \in \mathbb{Z}\}$.
3. (a) $(\pi n/2; \pi n/2 + \pi/4)$, $n \in \mathbb{Z}$;
- (b) $(4\pi n - 2\pi; 4\pi n)$, $n \in \mathbb{Z}$;
- (c) $[\pi n - \pi/12; \pi n + \pi/6)$, $n \in \mathbb{Z}$;
- (d) $(\pi n/3 - \pi/6 + 2/3; \pi n/3 - \pi/9 + 2/3)$, $n \in \mathbb{Z}$.
4. (a) $(\pi n + \pi/2; \pi n + \pi)$, $n \in \mathbb{Z}$;
- (b) $(\pi n + \pi/4; \pi n + \pi/2)$, $n \in \mathbb{Z}$;
- (c) $\left(\frac{\pi n}{2} + \frac{\pi}{3} - \frac{1}{2} \operatorname{arccot} 2; \frac{\pi n}{2} + \frac{\pi}{3} \right)$, $n \in \mathbb{Z}$.
5. (a) $(\pi n + \pi/6; \pi n + 5\pi/6)$, $n \in \mathbb{Z}$;
- (b) $(\pi n + \pi/3; \pi n + 2\pi/3)$, $n \in \mathbb{Z}$;
- (c) $[\pi n - \pi/4; \pi n + \pi/4]$, $n \in \mathbb{Z}$;
- (d) $(\pi n + \pi/6; \pi n + 5\pi/6)$,

- $n \in \mathbb{Z}$. 6. (a) $[2\pi n + \arcsin(1/3); 2\pi n + \pi/6) \cup (2\pi n + 5\pi/6; 2\pi n + \pi - \arcsin(1/3)]$, $n \in \mathbb{Z}$; (b) $[2\pi n + \pi - \arccos(1/4); 2\pi n + \pi + 2\pi/3) \cup (2\pi n + 4\pi/3; 2\pi n + \pi + \arccos(1/4)]$, $n \in \mathbb{Z}$;
 (c) $(\pi n - \arctan 2; \pi n + \arctan 3)$, $n \in \mathbb{Z}$;
 (d) $[\pi n + \operatorname{arccot} 1.5; \pi n + \pi - \operatorname{arccot} 4]$, $n \in \mathbb{Z}$.
 7. $(\pi/3 + 2\pi n; 2\pi/3 + 2\pi n)$, $n \in \mathbb{Z}$. 8. $[2\pi n - 2\pi/3; 2\pi n + 2\pi/3]$, $n \in \mathbb{Z}$. 9. $(\pi n - \arctan 2; \pi n + \pi/3)$, $n \in \mathbb{Z}$. 10. $(\pi n; \pi n + \pi/2] \cup [\pi n + 3\pi/4; \pi(n+1))$, $n \in \mathbb{Z}$.
 11. $(-\pi/4 + 2\pi n; \pi/6 + 2\pi n) \cup (5\pi/6 + 2\pi n; 5\pi/4 + 2\pi n)$, $n \in \mathbb{Z}$.
 12. $(2n - 1/8; 2n + 7/8)$, $n \in \mathbb{Z}$. • $\cos \pi x = \sin(\pi/2 - \pi x)$.
 13. $(\frac{\pi n}{2} + \frac{5\pi}{24}; \frac{\pi(n+1)}{2} + \frac{\pi}{24})$, $n \in \mathbb{Z}$. • Show that $\cos^3 x \sin 3x + \cos 3x \sin^3 x = (3/4) \sin 4x$. 14. $\{\pi/2 + \pi n\} \cup [\pi n - \pi/4; \pi n - \pi/6] \cup [\pi n + \pi/6; \pi n + \pi/4]$, $n \in \mathbb{Z}$; • $\cos x \cos 2x \cos 3x = \cos 2x \times \frac{\cos 2x + \cos 4x}{2} = \frac{\cos 2x(2 \cos^2 2x + \cos 2x - 1)}{2}$. 15. $\{\mathbb{R}\}$, except for $x = 3\pi/4 + 3\pi n/2$, $n \in \mathbb{Z}$. 16. $(-\pi/8 + \pi n/2; \pi/8 + \pi n/2)$, $n \in \mathbb{Z}$.
 • $\sin^6 x + \cos^6 x = \left(\frac{1 - \cos 2x}{2}\right)^3 + \left(\frac{1 + \cos 2x}{2}\right)^3 = \frac{5}{8} + \frac{3}{8} \cos 4x$.
 17. $(\pi n + \frac{1}{2} \arccos \frac{1}{3}; \pi(n+1) - \frac{1}{2} \arccos \frac{1}{3})$, $n \in \mathbb{Z}$. • $8 \sin^6 x - \cos^6 x = (2 \sin^2 x - \cos^2 x)(4 \sin^4 x + 2 \sin^2 x \cos^2 x + \cos^4 x)$. Prove that $4 \sin^4 x + 2 \sin^2 x \cos^2 x + \cos^4 x > 0$ for any $x \in \mathbb{R}$. 18. $(\pi n - \pi/4; \pi n - \pi/6) \cup (\pi n + \pi/6; \pi n + \pi/4)$, $n \in \mathbb{Z}$. 19. $(2\pi n - \frac{\pi}{4} + \arcsin \frac{2\sqrt{2}}{3}; 2\pi n + \frac{3\pi}{4} - \arcsin \frac{2\sqrt{2}}{3}) \cup (\pi(2n+1); 2\pi n + \frac{3\pi}{2})$, $n \in \mathbb{Z}$. • Set $\sin x + \cos x = y$. 20. $(\arctan(\sqrt{2}-1); \frac{\pi}{4}) \cup (\pi + \arctan(\sqrt{2}-1); \frac{5\pi}{4})$. 21. $(\pi n + \arcsin \frac{\sqrt{5}-1}{2}; \pi(n+1) - \arcsin \frac{\sqrt{5}-1}{2})$, $n \in \mathbb{Z}$. 22. $[2\pi n - 7\pi/6; 2\pi n + \pi/6]$, $n \in \mathbb{Z}$. 23. $(\pi/4 + \pi n; \pi/2 + \pi n)$, $n \in \mathbb{Z}$. 24. $[n + 1/4; n + 3/4]$, $n \in \mathbb{Z}$.
 25. $[4n^2\pi^2; (2n+1)^2\pi^2]$, $n \in \mathbb{Z}_0$. 26. $[-\sqrt{\frac{\pi}{2}}; \sqrt{\frac{\pi}{2}}] \cup [-\sqrt{\frac{\pi}{2}(4n+1)}; -\sqrt{\frac{\pi}{2}(4n-1)}] \cup [\sqrt{\frac{\pi}{2}(4n-1)}; \sqrt{\frac{\pi}{2}(4n+1)}]$, $n \in \mathbb{N}$. 27. $[-1/3; 1]$. 28. $[-\pi/6 + \pi n; \pi/6 + \pi n]$, $n \in \mathbb{Z}$. 29. $(-\infty; 0)$, except for $x = -n$, $n \in \mathbb{N}$. 32. • Investigate the sign of the derivative of the function $y = (\tan x)/x$ on the

interval $x \in (0; \pi/2)$. 33. $\left\{ \pi n; \pi n \pm \frac{1}{2} \arccos \left(-\frac{1+2 \sin a}{2} \right) \mid n \in \mathbb{Z} \right\}$
for $a \in (0; \pi/6] \cup [5\pi/6; 4)$, $\{ \pi n \mid n \in \mathbb{Z} \}$ for $a \in (\pi/6, 5\pi/6)$. 34.
 $\left\{ \pi n, \pi n \pm \frac{1}{2} \arccos \frac{2-\cos a}{2} \mid n \in \mathbb{Z} \right\}$ for $a \in \left[-1; \frac{\pi}{2} \right]$,
 $\{ \pi n \mid n \in \mathbb{Z} \}$ for $a \in \left(\frac{\pi}{2}; 3 \right]$. 35. $\{ \pi n \pm \arctan \sqrt{\operatorname{cosec} a - 1} \mid n \in \mathbb{Z} \}$
for $a \in [2; \pi) \cup (2\pi; 8)$; for $a \in [\pi; 2\pi]$ the function has no critical points.

Chapter 3

PROBLEMS ON DERIVING EQUATIONS AND INEQUALITIES

3.1. Problems on Motion

1. 60 km/h. 2. 2 km/h. 3. 60 km/h. 4. $39\frac{7}{12}$ km. 5. 4 km/h. 6. 40 km/h, 120 km/h. 7. 36 or 64 km/h. 8. 20 km/h, 12 km/h. 9. 1 km/h. 10. 30 km, 6 km/h, 4 km/h. \blacktriangle Suppose S is the required distance, v_1 and v_2 are the speeds of the persons travelling from points A and B respectively. The distances covered by the two people in equal time intervals are related as their speeds. Proceeding from this fact, we get a system of equations

$$\frac{S-12}{12} = \frac{v_1}{v_2}, \quad \frac{12+S-6}{S-12+6} = \frac{v_1}{v_2}.$$

Excluding v_1/v_2 from these equations, we get an equation $S^2 - 30 \cdot S = 0$, whence we find that $S = 30$. The speeds of the travellers can be found from the equations $S + 6 = 6v_1$, $S - 6 = 6v_2$. 11. $8a$ km, $\frac{8a}{3b}$ km/h, $\frac{8a}{5b}$ km/h. 12. 10 km. 13. 18 km/h. 14. $l(t_2/t_1 + 1)$ cm; $l^2 \frac{(t_1 + t_2)}{t_1(lt_2 + (S+l)t_1)}$ cm/s; $\frac{lS}{lt_2 + (S+l)t_1}$ cm/s. 15. 20 m/min; 15 m/min; 280 m. 16. $(8 \pm \sqrt{7})/2$ h, 4.5 h, 3.5 h, 9.5 h, $(8 + \sqrt{127})/2$ h. 17. 10 km/h, 3 km/h. 18. 18 km/h, 24 km/h. 19. 5 km/h, 4 km/h. 20. $0.5(b + \sqrt{b^2 + 4ab})$ km. 21. $(10 + \sqrt{52})$ km, $(\sqrt{52} \pm 2)$ km. 22. 15 : 8. 23. 4 h. 24. 18 min. 25. $\sqrt{10}$ times. \blacktriangle Suppose S is the distance between points A and B , u is the actual speed of the tugboat, v is the speed of the river flow. We derive a system of equations:

$$\frac{S}{u+v} + \frac{S}{u-v} = 13, \quad \frac{S}{2u+v} + \frac{S}{2u-v} = 6.$$

Setting $u/v=x$, $u=xv$ and dividing the first equation by the second, we get an equation $\frac{2Sx}{x^2-1} : \frac{4Sx}{4x^2-1} = \frac{13}{6}$, whence we find x .

26. $a(\sqrt{2}+1)$ h. 27. 10 and 5 h. 28. 3 and 6 h, or $(\sqrt{145}-1)/6$ h and $\frac{\sqrt{145}+17}{6}$ h. 29. $\frac{m(p+n)+2np}{2p}$ min, $\frac{m(p+n)+2np}{2n}$ min, $\frac{m(p+n)+2np}{p+n}$ min. 30. 36 h, 45 h. ▲ We find the time t that cars travelled until they met, for which purpose we set up a system of equations:

$$16v_1 = v_2 t, \quad 25v_2 = v_1 t.$$

Dividing the first equation by the second, we get $(v_1/v_2)^2 = 25/16$ or $v_1/v_2 = 5/4$, and now it is easy to find t . 31. 3 h. 32. 10 h 29 min. ▲ Suppose S is the distance between points A and B , v_1 and v_2 are the speeds of the first and the second car respectively, t is the speed at which the cars travelled until they met. We have the following system of equations:

$$S = (v_1 + v_2)t, \quad S = (2v_1 + v_2)\left(t - \frac{14}{15}\right), \quad S = (v_1 + 2v_2)\left(t - \frac{13}{12}\right),$$

from which we have

$$\frac{v_1 + v_2}{S} = \frac{1}{t}, \quad \frac{2v_1 + v_2}{S} = \frac{1}{t - 14/15}, \quad \frac{v_1 + 2v_2}{S} = \frac{1}{t - 13/12}.$$

Adding together the last two equations and taking the first equation into account, we get an equation $\frac{3}{t} = \frac{1}{t - 14/15} + \frac{1}{t - 13/12}$, which, after simple transformations, assumes the form $30t^2 - 121t + 91 = 0$, whence we have $t_1 = 1$ (extraneous solution) and $t_2 = 182/60$. If we double the speeds of both cars, then the time that they travelled until they met is

$$\tau = \frac{S}{2(v_1 + v_2)} = \frac{t_2}{2} = 1 \text{ h } 31 \text{ min.}$$

Subtracting this result from 12, we get the answer.

3.2. Problems on Percentages, Mixtures, Numbers and Work

1. 15 m. 2. 60%. 3. 25 days, 20 days, 30 days.
4. 10 days. 5. 10 h, 15 h. 6. 16 h. 7. Six times.
8. 3h, 6h, 2h. 9. 14h, 10.5h. 10. $\frac{1}{4} [2(t+d) - \sqrt{2t^2 + 4d^2}]$, $\frac{1}{4} [2(t-d) - \sqrt{2t^2 + 4d^2}]$. The problem has a solution if $t > 4d > 0$.

11. 40 m, 25 m. 12. 45 metres of black fabric, 36 metres of green fabric and 30 metres of blue fabric. 13. 50 m³/min. 14. 4.8 h; 4.8 h or 4 h; 6 h. 15. 15 h. \blacktriangle Suppose x is the time period for which the second valve was open, p_1 and p_2 are the speeds of water flow through the first and the second valve respectively. Then we have a system

$$p_1(x+5) + p_2x = 425, \quad 2p_1x = p_2(x+5), \quad (p_1 + p_2)17 = 425.$$

From the second and the third equation we get

$$p_1 = 25 \frac{x+5}{3x+5}; \quad p_2 = \frac{50x}{3x+5}.$$

Substituting these expressions into the first equation, we find $3x^2 - 41x - 60 = 0$, whence it follows that $x = 15$ ($x = -4/3$ is an extraneous root). 16. 2 h. 17. 6 h. 18. 10 min. 19. $(2(30p - 1950))/(434 - 7p)$ kg, $(5(30p - 1950))/(434 - 7p)$ kg. The problem has a solution for $62 < p < 65$. 20. $(4q - 280)/(90 - q)$

litres. The problem has a solution for $70 \leq q \leq 76 \frac{2}{3}$. 21. 25%.

22. 749 monetary units. 23. 0.25 litre of glycerin, 1.75 litres of water.

24. $\frac{9k+1}{k-1} a\%$. 25. $12p/(4a^2 - 7a + 3)\%$; $12a^2p/(4a^2 - 7a + 3)\%$, $12ap/(4a^2 - 7a + 3)\%$. 26. 64; 46. 27. 63. 28. 863. 29. 36; 63.

3.3. Problems on Deriving Inequalities and Systems of Inequalities. Problems on the Extremum

1. 7842. 2. $[4; (8 + \sqrt{61})/3]$. 3. 8. 4. (3; 5]. 5. 12. 6. 180 roubles. \blacktriangle Suppose x roubles is the initial payment of each student, y is the number of students in the group, then $170 < xy < 195$, $xy = (x+1) \times (y-2)$. This equation yields $x = (y-2)/2$. Substituting this value of x into the system of inequalities, we find that $1 + \sqrt{341} < x < y < 1 + \sqrt{391}$. Since y is a natural number, the last system of inequalities is satisfied by two numbers: 19 and 20. All conditions of the problem are fulfilled only at $y = 20$, $x = 9$, and, therefore, $xy = 9 \cdot 20 = 180$. 7. 9 roubles. 8. 3 t. 9. 6 h. \blacktriangle Suppose S is the distance between points A and B , u is the actual speed of the motor-launch, v is the speed of the river flow. Then we have the following system of equations and inequalities:

$$\frac{S}{v} = 24, \quad \frac{S}{u+v} + \frac{S}{u-v} \geq 10, \quad \frac{S}{1.4u+v} + \frac{S}{1.4u-v} \leq 7.$$

We have to determine $S/(u-v)$. Assuming that $u/v = x$ by the meaning of the problem $x > 1$), we transform the inequalities:

$$\frac{S}{v} \left(\frac{1}{x+1} + \frac{1}{x-1} \right) \geq 10, \quad \frac{S}{v} \left[\frac{1}{1.4x+1} + \frac{1}{1.4x-1} \right] \leq 7.$$

Since $S/v = 24$ and $x > 1$, the transformations lead to a system of inequalities, which is equivalent to the original system:

$$5x^2 - 24x - 5 \leq 0, \quad 1.96x^2 - 9.6x - 1 \geq 0.$$

This system is consistent for $x = 5$. Then we obtain

$$\frac{S}{u-v} = \frac{S}{v} \cdot \frac{1}{x-1} = 24 \cdot \frac{1}{5-1} = 6.$$

18. 11 twos, 7 threes, 10 fours, 2 fives. \blacktriangle Suppose x is the number of twos, y is the number of threes, z is the number of fours and t is the number of fives. We have a system

$$\begin{aligned} x + y + z + t &= 30, & 2x + 3y + 7z + 3t &= 93, & y > t &= 2m, \\ y < z &= 10k, & m \in \mathbb{Z}_0, & k \in \mathbb{Z}_0. \end{aligned}$$

Substituting the value of x from the first equation, $x = 30 - (y + z + t)$, into the second equation, we obtain: $y + 3t = 33 - 2z$. Hence we find z . It follows from the hypothesis that z can only assume the values 0, 10, 20, 30.

The value $z = 0$ will not do since the inequality $y < 0$ loses sense; $z = 20$ and $z = 30$ will not do either since then the inequality $33 - 2z \geq 0$ is not satisfied. Hence $z = 10$. Furthermore, we have $y = 13 - 3t > t$, whence we get $0 \leq t < 3.25$. For $t = 0$ we have $y = 13 > z$ (which does not satisfy the condition of the problem). Consequently, $t = 2$ and $y = 13 - 6 = 7$, and then we find $x = 30 - (7 + 10 + 2) = 11$. 11 limes, 5 birches. \blacktriangle Suppose x is the number of birches and y is the number of limes. We have a system of inequalities

$$x + y > 14, \quad 2y < x + 18 \quad 2x < y.$$

Adding the third inequality to the second, we get $x + y < 18$. Thus three cases are possible here: $x + y = 15$, $x + y = 16$ and $x + y = 17$. Let us consider these cases:

(1) if $y = 15 - x$, then

$$\begin{cases} 2(15-x) < x+18, \\ 2x < 15-x \end{cases} \Rightarrow 4 < x < 5.$$

Since x is a natural number, we see that this case is impossible,

(2) if $y = 16 - x$, then

$$\begin{cases} 2(16-x) < x+18, \\ 2x < 16-x \end{cases} \Rightarrow 4 \frac{2}{3} < x < 5 \frac{1}{3};$$

$x = 5$ satisfies the system, $y = 16 - 5 = 11$;

(3) for $y = 17 - x$

$$\begin{cases} 2(17-x) < x+18, \\ 2x < 17-x \end{cases} \Rightarrow 5 \frac{1}{3} < x < 5 \frac{2}{3}.$$

As in the first case, there are no natural x here which can satisfy the system of inequalities. Thus, only one case is possible, when

$x = 5$, $y = 11$. 12. $5\frac{4}{7}$ min. 13. $\frac{25}{7}$ m³/h. \blacktriangle Suppose S is the volume

of the reservoir ($S > 0$), then

$$t(v) = \frac{0.3S}{30 + (30 - 3v)} + \frac{0.7S}{30 + (30 - 3v) + (30 + 10v)}$$

$$= \frac{S}{10} \left(\frac{1}{20 - v} + \frac{7}{90 + 7v} \right).$$

We find the derivative of the function $t(v)$:

$$t'(v) = \frac{S}{10} \left(\frac{1}{(20 - v)^2} - \frac{49}{(90 + 7v)^2} \right), \quad t'(v) = 0 \text{ for } v = \frac{25}{7},$$

$$\frac{25}{7} \in (1, 10);$$

at the point $v = 25/7$ the derivative changes sign (at the point on the left the values of the derivative are negative and on the right they are positive) and, therefore, at the point $v = 25/7$ the function $t(v)$ has a minimum. 14. 6 km/h. ● Determine whether the function $t(v) = 6/v + 2/3 + 0.25v(2/3 + 6/v)$, $v > 0$, where $t(v)$ is the full time of the travel of the pedestrian, has an extremum. 15. 0 litres if $p \in (20; 100]$; [0, 3] litres if $p \in \{20\}$; 3 litres if $p \in (0; 20)$. 16. 62.5 and 55%. ▲ Suppose we have taken x kg of the first alloy, y kg of the second and z kg of the third. Since the resulting alloy contains 15% of bismuth, we have an equation $3x + y - 3z = 0$, with $z \neq 0$ and $z \geq x$. The percentage of lead in the new alloy is equal to

$$p(x) = 5 \frac{11x + 10y + 14z}{x + y + z} = \frac{5}{2} \cdot \frac{44z - 19x}{2z - x} = \frac{5}{2} \cdot \frac{44 - \frac{x}{z}}{2 - \frac{x}{z}},$$

$$0 \leq \frac{x}{z} \leq 1.$$

The function $p(x/z)$ assumes the greatest and the least value at the end-point of the interval: for $x/z = 0$ and for $x/z = 1$. 17. 0 m/s²,

11 $\frac{1}{3}$ m. ● To find the distance, use the formula $S = \int_0^4 |v(t)| dt$.

Chapter 4

THE ANTIDERIVATIVE AND THE INTEGRAL

4.1. The Antiderivative. The Newton-Leibniz Formula

1. (a) $2x + C$; (b) $x - 1.5x^2 + C$; (c) $(2x - 1)^2 + C$. 2. (a) $C - x^3/3$; (b) $x^3/3 - 2x^2 - \sqrt{3}x + C$; (c) $2(3x + 2)^3 + C$. 3. (a) $0.5x^2 - 0.75x^4 + C$;

(b) $\frac{x^2}{4} + \frac{x^6}{6} + C$; (c) $\frac{x^3}{3} - \frac{x^6}{5} + C$; (d) $(3x-4)^{101}/303 + C$; (e) $C - (1-5x)^8/40$. 4. (a) $C - 1/x$, (b) $-\frac{1}{2}x^2 - \frac{1}{2x^2} + C$; (c) $2x^2 - \frac{1}{2(2x-1)} + C$; (d) $\frac{1+x^2}{(1-x^2)^2} + C$. 5. (a) $\frac{\sqrt{x}}{2} + C$; (b) $\frac{3}{4}x\sqrt[3]{x} - x + C$; (c) $\frac{x^2}{2} + \frac{4}{7}x^4\sqrt{x^3} + C$; (d) $x\left(\frac{7}{8}\sqrt[7]{x} - \frac{5}{6}\sqrt[5]{x} + \frac{6}{7}\sqrt[6]{x}\right) + C$; (e) $\frac{2}{3}(x+2)\sqrt{x+2} + C$; (f) $\frac{(4x-5)\sqrt{5-4x}}{6} + C$. 6. (a) $2\ln|x| + C$; (b) $C - \frac{1}{2}\ln|x|$; (c) $-\ln|1-x| + C$; (d) $\frac{3}{4}\ln|4x-1| + C$. 7. (a) $\ln\left|\frac{x+1}{x-1}\right| + C$; (b) $\ln|x/(x+1)| + C$. $\bullet \frac{1}{x(x+1)} = \frac{1}{x} - \frac{1}{x+1}$; (c) $\frac{1}{3}\ln\left|\frac{x+1}{x+4}\right| + C$; (d) $\ln|x^2+3x| + C$. $\bullet \frac{2x+3}{x^2+3x} = \frac{x+x+3}{x(x+3)} = \frac{1}{x+3} + \frac{1}{x}$. 8. (a) $\arctan x + C$; (b) $\arctan \frac{x}{2} + C$. $\bullet \frac{2}{x^2+4} = \frac{1}{2} \times \frac{1}{1+(x/2)^2}$; (c) $3\arctan x - 1/x + C$. $\bullet \frac{4x^2+1}{x^2(1+x^2)} = \frac{3}{1+x^2} + \frac{1}{x^2}$; (d) $\ln|x| + 2\arctan x + C$. $\bullet \frac{(x+1)^2}{x(1+x^2)} = \frac{(x^2+1)+2x}{(x^2+1)x} = \frac{1}{x} + \frac{2}{1+x^2}$. 9. (a) $4\arcsin x + C$; (b) $\frac{1}{2}\arccos 2x + C$; (c) $\arcsin x + \frac{1}{2}\ln\frac{1+x}{1-x} + C$. $\bullet \frac{\sqrt{1-x^2}+1}{1-x^2} = \frac{1}{\sqrt{1-x^2}} + \frac{1}{1-x^2} = \frac{1}{\sqrt{1-x^2}} + \frac{1}{2}\left(\frac{1}{1-x} + \frac{1}{1+x}\right)$. 10. (a) $2^x/\ln 2 + C$; (b) $-3^{-x}/\ln 3 + C$; (c) $(e^{4x}+x^2)/2 + C$; (d) $C - e^{-x}$; (e) $(e^x - e^{-x})/2 + C$; (f) $(e^x + e^{-x})/2 + C$. 11. (a) $C - 2\cos x$; (b) $C - 6\cos \frac{x}{2}$; (c) $C - \cos\left(x - \frac{\pi}{3}\right)$; (d) $\frac{1}{2}\cos\left(10x + \frac{\pi}{8}\right) + C$. 12. (a) $4\sin x + C$; (b) $C - 10\sin \frac{x}{5}$; (c) $2\sin\left(\frac{x}{2} + \frac{\pi}{6}\right) + C$; (d) $\frac{2}{7}\sin(7x-1) + C$. 13. (a) $\frac{x}{2} - \frac{\sin 2x}{4} + C$. $\bullet \sin^2 x = \frac{1-\cos 2x}{2}$; (b) $-x - \frac{\sin 4x}{4} + C$; (c) $\frac{1}{4}\sin 4x + \frac{1}{6}\sin 6x + C$. $\bullet 2\cos x \cos 5x = \cos 4x + \cos 6x$; (d) $\frac{1}{3}\sin 3x - \frac{1}{11}\sin 11x + C$; (e) $-\frac{1}{5}\cos 5x - \frac{1}{11}\cos 11x + C$; (f) $\frac{1}{10}\cos 10x -$

- $-\frac{1}{12} \cos 12x + C$. 14. (a) $\frac{3}{4} \tan 4x + C$; (b) $-4 \cot \frac{x}{2} + C$; (c) $\tan x - x + C$. ● Use the identity $1 + \tan^2 x = 1/\cos^2 x$; (d) $C - \cot x - x$.
15. (a) $x^3 - 2x$. ▲ $F(x) = \int (3x^2 - 2) dx = x^3 - 2x + C$. We have $F(2) = 2^3 - 2 \cdot 2 + C = 4$, whence we get $C = 0$; (b) $x + \sin x + (1/2) \sin 2x + 1$; (c) $3 \sin x + 2 \cos x - 2$; (d) $2e^{x/2} + 1$.
16. (a) $\arcsin^2 x$, (b) $\sin^5 x \sqrt{1+x^2}$. 17. (a) $\{-4, 1\}$. ● $f'(x) = x(x+1)(x+2)(x+3) - 24$; (b) $\left\{ \frac{\pi n}{2} + \frac{\pi}{4} \mid n \in \mathbb{Z}_0 \right\}$; (c) $\left\{ \frac{\pi n}{4} + \frac{\pi}{8}; \pi n \pm \frac{\pi}{3} \mid n \in \mathbb{Z} \right\}$; (d) $\{ \pi n/2 \pm (1/4) \arccos(2a-1)/3 \mid n \in \mathbb{Z} \}$ for $a \in (-1, 2]$, for $a \notin [1, 2]$ the function has no critical points; (e) $\{ \pi n + (-1)^n \pi/6 \mid n \in \mathbb{Z} \}$. 18. (a) $-33 \frac{3}{4}$; (b) 0; (c) 1; (d) π ; (e) 2π .
19. $\left\{ \frac{1}{2}; 2 \right\}$. 20. (0; 4). 21. $\{ \pi/2; 7\pi/6; 3\pi/2; 11\pi/6 \}$. 22. $\{-1/4\}$.

4.2. Calculating the Areas of Plane Figures

1. (a) $1/2$; (b) 4; (c) $9/8$. ● Carry out the integration with respect to the variable y ; (d) $25/2$. ● To find the limits of integration, solve the systems of equations:

$$\begin{cases} 3x - 4y = -11, \\ 4x + 3y = 27; \end{cases} \quad \begin{cases} 3x - 4y = -11, \\ x + 7y = 13; \end{cases} \quad \begin{cases} x + 7y = 13, \\ 4x + 3y = 27. \end{cases}$$

2. (a) $\frac{64}{3}$; (b) 18; (c) 90; (d) 8; (e) $\frac{32}{3}$; (f) 4.5. 3. (a) 4.5; (b) 4; (c) $57 \frac{1}{6}$. ● Calculate the area of the figure in the new system of coordinates, obtained from the old system by means of the translation $\vec{r}(0; -4)$; (d) $1/6$; (e) $37/48$. 4. $19/24$. 5. $9/8$. 6. 0.5. 7. $125/2$. 8. $\{ \pm \sqrt{2/3} \}$. 9. $\{-1; \sqrt[3]{8 - \sqrt{17}}\}$. ● Consider the cases $c < 1$ and $c > 1$. 10. (a) $23 - 5 \ln \frac{28}{5}$; (b) $\frac{3}{4} - \ln 2$; (c) $12 - 5 \ln 5$; (d) $(2\sqrt{5} - 3)/2 + \ln(\sqrt{5} - 1)/2$. 11. (a) 4; (b) 3; (c) $23275/4$. 12. $4 \ln(3/2) - 1.5$. 13. $\{1/4; 49/4\}$. ● Consider the cases $c < 4$ and $c > 4$. 14. (a) $7/6$; (b) $1/3$; (c) $8/9$; (d) $548/3$. 15. (a) 9; (b) $2\frac{2}{3}$; (c) $35\frac{5}{24}$. 16. (a) $1/3 + \ln 2$; (b) $13/3 - 4 \ln 2$; (c) $16.5 - 8 \ln 2$; (d) $48 \ln 2 - 11.25$; (e) $20/3$; (f) $\ln 2$. 17. (a) $4 - \ln 3$; (b) $\frac{1}{6} \ln \frac{3e}{8}$. 18. $\{(12 - 2\sqrt{21})/5; 8\}$.
- ▲ The curves $y = 1/x$ and $y = 1/(2x - 1)$ meet at the point $O_1(1; 1)$

(this follows from the solution of the equation $1/x = 1/(2x - 1)$). Let us consider the possible cases of location of the curve $x = a$: $1/2 < a < 1$, $1 < a < 2$ and $a > 2$. (1) If $1/2 < a < 1$, then the area of the figure (see the figure) is equal to the sum of the areas of the figures EO_1F and AO_1B :

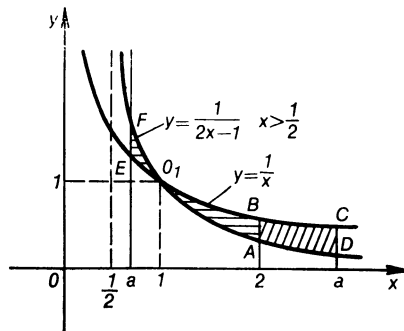

$$\ln \frac{4}{\sqrt{5}} = \int_a^1 \left(\frac{1}{2x-1} - \frac{1}{x} \right) dx + \int_1^2 \left(\frac{1}{x} - \frac{1}{2x-1} \right) dx.$$

Integrating the right-hand part, we get

$$\begin{aligned} \ln \frac{4}{\sqrt{5}} &= \frac{1}{2} \ln \left| \frac{2x-1}{x^2} \right|_a^1 + \frac{1}{2} \ln \left| \frac{x^2}{2x-1} \right|_1^2 \\ &= \frac{1}{2} \ln 1 - \frac{1}{2} \ln \frac{2a-1}{a^2} + \frac{1}{2} \ln \frac{4}{3} \end{aligned}$$

or

$$\ln \frac{2\sqrt{3}}{\sqrt{5}} = \frac{1}{2} \ln \frac{a^2}{2a-1}. \quad (1)$$

The right-hand side of equation (1) is the area of the curvilinear triangle EO_1F ($\ln \frac{2\sqrt{3}}{\sqrt{5}} > 0$). Next we have $a^2/(2a-1) = 12/5$,

$$5a^2 - 24a + 12 = 0; \quad (2)$$

$a_1 = (12 - 2\sqrt{21})/5$, $a_2 = (12 + 2\sqrt{21})/5$. We find that the condition $1/2 < a < 1$ is fulfilled only by the root a_1 .

(2) Under the conditions $1 < a < 2$, the straight line $x = a$ does not exist (it is established that in the case $1/2 < a < 1$, the area of the given figure is larger than the area of the curvilinear triangle AOB).

(3) In the case $a > 2$, the area of the given figure is equal to the area of the figure $ABCD$:

$$\ln \frac{4}{\sqrt{5}} = \int_2^a \left(\frac{1}{x} - \frac{1}{2x-1} \right) dx. \quad (3)$$

After integrating the right-hand side of the resulting equation and transforming it, we obtain $15a^3 - 128a + 64 = 0$; $a_3 = 8$, $a_4 = 8/15$. The value of a_4 does not satisfy the inequality $a > 2$ and is, therefore, extraneous. Thus, the condition of the problem is satisfied by the values $a \in \{(12 - 2\sqrt{21})/5; 8\}$. 19. (a) $\log_3 e$; (b) $\log_4 e$; (c) $(30 - 8 \ln 2)/\ln 2$; (d) $8(1 - 1/(81 \ln 3))$. 20. (a) $2e^3 + 1$; (b) $(e^3 - 4)/e^4$; (c) $33/2 + e^{-5}$; (d) $e^2 - 2$. 21. $360/(\ln 3) - 162$. ● To find the values of k and m , solve the system of equations

$$k + m = 34, \quad 3^{-1}k + m = 14.$$

22. $4 \log_5 \frac{e^4}{27}$. ● To find the coefficient b , solve the equation

$\tan(\arctan 40 \ln 5) = b5 \ln 5$. 23. $3.5 - 12 \ln \frac{4}{3}$. 24. (a) 4. ● $S =$

$$= \int_0^{2\pi} |\sin x| dx = \int_0^{\pi} \sin x dx + \int_{\pi}^{2\pi} (-\sin x) dx; \text{ (b) } 1/(3\sqrt{2}); \text{ (c) } 2\sqrt{2};$$

(d) $(\sqrt{2} + \sqrt{3})/4$. 25. (a) $\pi\sqrt{3}/12 + \sin 1 - 1/2$; (b) $1 + \pi/3 - \cos 3 - \sqrt{3}$; (c) $(2\sqrt{2}/3) \arcsin(2\sqrt{2}/3) - 2/3$; (d) $2 + \cos 2$.

26. (a) $\{-\pi/18, \pi/9\}$. ● Consider the cases $-\frac{\pi}{6} \leq k < \frac{\pi}{18}$ and $\frac{\pi}{18} < k \leq \frac{\pi}{6}$; (b) $\{-\frac{\pi}{30}, \frac{\pi}{6}\}$. 27. (a) π . ▲ Since the integrand

function $y = \sqrt{4-x^2}$ is nonnegative on the interval $[0; 2]$, the value of the required integral is numerically equal to the area of the figure bounded by the curves $y = \sqrt{4-x^2}$, $x=0$, $x=2$, $y=0$, which is a quarter of a circle of radius 2 (see the figure). Thus,

the value of the integral is $\pi \cdot 2^2/4 = \pi$; (b) $\frac{2\pi - 3\sqrt{3}}{6}$. ● $I =$

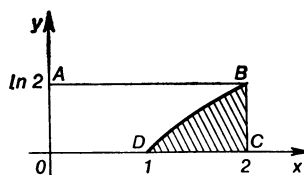
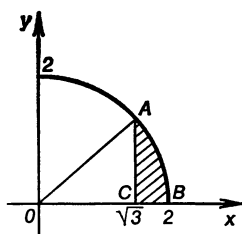

$= S_{ABC} = S_{AOB} - S_{AOC}$ (see the figure). 28. $2 \ln 2 - 1$. ▲ $I = S_{BCD} = S_{OABC} - S_{ABDO}$ (see the figure). Let us find the areas of the figures $OABC$ and $ABDO$. Since $OABC$ is a rectangle, we have $S_{OABC} = 2 |BC|$, and $|BC| = \ln 2$; therefore, $S_{OABC} = 2 \ln 2$.

The area of the curvilinear trapezoid $ABDO$ can be found by integrating the function $x = e^y$ in the limits from 0 to $\ln 2$ (the ordinates of the points O and A respectively):

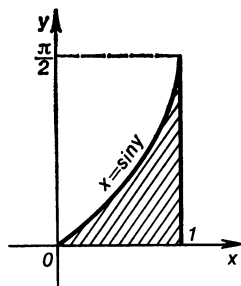

$$S_{ABDO} = \int_0^{\ln 2} e^y dy = e^{\ln 2} - 1 = 1.$$

We finally have $I = 2 \ln 2 - 1$. Δ The value of the integral is equal to the area S of the hatched figure (see the figure). We find that area:

$$S = \int_0^{\pi/2} 1 dy - \int_0^{\pi/2} \sin y dy = \frac{\pi}{2} - 1.$$

Chapter 5

PROGRESSIONS AND NUMBER SEQUENCES

5.1. Progressions

1. No, it is not. \bullet Show that the equation $1 + 4(n - 1) = 10091$ has no integer solutions. 2. 13. 3. 99270. 4. 16, 12, 8, . . . , -16, -20. Δ Suppose a_1 is the first term of the progression, d is its common difference. We derive a system of equations:

$$\begin{cases} a_1 + a_2 + \dots + a_{n-2} + a_{n-1} = 0, \\ a_2 + a_3 + \dots + a_{n-1} + a_n = -36, \\ a_{10} - a_6 = -16. \end{cases}$$

From the third equation we have $(a_1 + 9d) - (a_1 + 5d) = -16$; $d = -4$. Subtracting the second equation of the system from the first, we get $a_1 - a_n = 36$ or $-d(n - 1) = 36$, $-(-4)(n - 1) = 36$ and $n = 10$. To find a_1 , we transform the left-hand side of the first equation:

$$\frac{a_1 + a_{n-1}}{2} (n - 1) = \frac{a_1 + a_1 - 4(9 - 1)}{2} \cdot 9 = 0; \quad a_1 = 16.$$

5. 11, 13, 15, . . . , 29, 31. 6. 1, 3, 5, . . . , 17, 19. 7. 7. 8. 8, 12, 16, . . . Δ From the hypothesis we have a system

$$\begin{cases} a_2 = a_1 + d = 12, \\ 200 < \frac{a_1 + a_9}{2} \cdot 9 < 220. \end{cases}$$

From the equation of the system, we express a_1 in terms of d and substitute it into the inequality $200 < ((2(12 - d) + 8d)/2) \cdot 9 < 220$. After the transformations, we get $3\frac{11}{27} < d < 4\frac{4}{27}$. Since all the terms of the progression are natural numbers, the common difference d of the

progression must be an integer. The last inequality is satisfied by $d = 4$ (there are no other integers on the interval $(3\frac{11}{27}; 4\frac{4}{27})$). Then we find the first term of the progression: $a_1 = 12 - 4 = 8$. 9. -4 . 10. $5; 9; 13; \dots$. 11. $a_1 = 4; d = 5$. 12. $1/9, 1/6, 1/3$. \blacktriangle Suppose x, y, z are the required numbers; we have a system of equations

$$\begin{cases} x + y + z = 0.6 \quad (1) = \frac{11}{18}; \\ \frac{1}{x} + \frac{1}{y} + \frac{1}{z} = 18, \\ \frac{1}{x} + \frac{1}{z} = \frac{2}{y}. \end{cases}$$

($1/x; 1/y; 1/z$ here are the consecutive terms of the progression.) Subtracting the third equation of the system from the second, we get $y = 1/6$. Substituting this value of y into the first and the second equation of the system, we obtain a system

$$\begin{cases} x + z = 4/9, \\ (x + z)/(xz) = 12, \end{cases}$$

whose solutions can be found by means of the substitution $z = 4/9 - x$ into its second equation. 13. $-3a/\sqrt{28}, -2a/\sqrt{28}, -a/\sqrt{28}, \dots; 3a/\sqrt{28}, 2a/\sqrt{28}, a/\sqrt{28}, \dots$. 14. $\{\pm\sqrt{25b - 9}/4\}$ for $b \in [1; \infty)$. \blacktriangle From the hypothesis we have a system of equations

$$\begin{cases} a_2 a_{12} = 1, \\ a_4 a_{10} = b. \end{cases}$$

Since $a_7 = a_1 + 6d$, it follows that $a_1 = a_7 - 6d$ and we can reduce the system obtained to the form

$$\begin{cases} (a_7 - 5d)(a_7 + 5d) = 1, \\ (a_7 - 3d)(a_7 + 3d) = b \end{cases} \quad \text{or} \quad \begin{cases} a_7^2 - 25d^2 = 1, \\ a_7^2 - 9d^2 = b, \end{cases}$$

whence we find that $d^2 = (b - 1)/16$ and $a_7^2 = (25b - 9)/16; a_7 = \pm\sqrt{25b - 9}/4$. Since the inequalities $d^2 \geq 0, a_7^2 \geq 0$ must be satisfied, the following inequalities must hold true simultaneously:

$$b - 1 \geq 0 \quad (1) \quad \text{and} \quad 25b - 9 \geq 0. \quad (2)$$

Solving the system of linear inequalities (1) and (2), we find that $b \in [1; \infty)$. For other values of the parameter b , the system of equations has no real solutions, i.e. there is no arithmetic progression whose terms are real numbers. 15. $(116k - 39)/90$ for $k \in [-6, 3/2]$. 16. $(34 - 29b)/10$ for $b \in [1; 9/4]$. 17. $-(p + q)$. 18. 6.

\blacktriangle We have $\frac{a_1 + a_n}{2} = n = \frac{a_{n+1} + a_{2n}}{4} = n$ by the hypothesis, whence we obtain $a_1 + a_n = \frac{1}{2}(a_{n+1} + a_{2n})$. Now we can find the required

relation:

$$\frac{(a_1 + a_{3n}) 3n}{2} : \frac{a_1 + a_n}{2} \quad n = \frac{3(a_1 + a_{3n})^2}{a_{n+1} + a_{2n}} = 6 \frac{2a_1 + d(3n-1)}{2a_1 + d(n+2n-1)} = 6.$$

19. $-1; 0; 1; 2$. \blacktriangle Suppose $a - d, a, a + d$ and $a + 2d$ are the required numbers. We assume that the progression is increasing. Then we have an equation, which we solve for a :

$$(a-d)^2 + a^2 + (a+d)^2 = (a+2d)^2, \quad 3a^2 - a + 2d^2 - 2d = 0; \\ a = (1 \pm \sqrt{-24d^2 + 24d + 1})/6. \quad (1)$$

Real solutions exist if

$$-24d^2 - 24d + 1 \geq 0 \quad \text{or} \quad \frac{12 - \sqrt{168}}{24} \leq d \leq \frac{12 + \sqrt{168}}{24}.$$

There are only two integers in this interval, 0 and 1. We reject 0 since, by the hypothesis, all the required numbers are different. For $d = 1$ we find from (1) that $a = 0, a - d = -1; a + d = +1, a + 2d = 2$. 20. 13. 21. $(np/2)(1 + np)$. 22. 2.4. 23. $a_1 = 8, q = 2$.

24. 39 or -10.5 . 25. ± 4 . 26. 2, 6, 18, \dots ; 18, 6, 2, \dots . 27. $\sqrt[3]{A/B}$
28. $12/q^{100}$. 29. S_2/S_1 . \blacktriangle By the hypothesis we have a system

$$\begin{cases} a_1 + a_3 + \dots + a_{999} = S_1, \\ a_2 + a_4 + \dots + a_{1000} = S_2. \end{cases}$$

We multiply the denominator by the common ratio q of the progression:

$$a_1q + a_3q + \dots + a_{999}q = a_2 + a_4 + \dots + a_{1000} = S_2q.$$

Solving then the equation $S_2 = S_1q$, we get the answer. 30. $\pm \sqrt[10]{S_2/S_1}$.
31. 6. \blacktriangle Suppose a_1 is the first term of the progression, q is its common ratio and n is the number of the terms. Then we have a system of equations

$$\begin{cases} a_1 + a_1q^{n-1} = 66, \\ a_1^2q^{n-1} = 128, \\ \frac{a_1(1-q^n)}{(1-q)} = 126. \end{cases}$$

Multiplying the first equation of the system by a_1 and taking into account that $a_1^2q^{n-1} = 128$, we get $a_1^2 - 66a_1 + 128 = 0; (a_1)_1 = 64$ and $(a_1)_2 = 2$. Furthermore, we find from the second equation that $(q^{n-1})_1 = 1/32$ and $(q^{n-1})_2 = 32$. Since $q^n = (q^{n-1})q$, we can substitute the values of a_1 and q^{n-1} we have obtained into the third equation of the system and find the common ratio of the progression $q_1 = 1/2, q_2 = 2$. The progression being increasing, the common ratio q_1 is extraneous. Solving now the equation $2^{n-1} = 32 = 2^5$, we get the answer. 32. 600 m/min. \blacktriangle Suppose v_1, v_2 and v_3 (m/min) are, respectively, the speeds of the first, the second and the third skater. It follows from the hypothesis that $v_3 < v_1 < v_2$, i.e. $v_1^2 = v_2v_3$. Furthermore,

we have a system of equations

$$\begin{cases} v_2 t = v_1 t + 400, \\ v_1 t = v_3 (t + 2/3), \end{cases}$$

where t is the time during which the second skater ran a circle more than the first. Excluding t from these equations, we get $(v_2 - v_1) v_3 / (v_1 - v_3) = (v_1^2 - v_1 v_3) / (v_1 - v_3) = v_1 = 600$. 33. ● $S_{2n} - S_n = a_{n+1} + a_{n+2} + \dots + a_{2n} = a_{n+1} (1 - q^n) / (1 - q)$, $S_{3n} - S_{2n} = a_{2n+1} (1 - q^n) / (1 - q)$. 34. $\sqrt{2/3}$. 35. $1029/38$. ▲ Suppose the sequence $a_1, a_2, \dots, a_n, \dots$ is a geometric progression. We shall show that the sequence $a_1^k, a_2^k, \dots, a_n^k, \dots$, $k \in \mathbb{N}$, is also a geometric progression. Indeed, since $a_{i+1} = a_i q$, $i \in \mathbb{N}$, it follows that

$$a_{i+1}^k = a_i^k q^k \quad \text{and} \quad a_{i+1}^k / a_i^k = q^k = \text{const},$$

independent of the ordinal number of the term i of the progression. Thus, the sequences of the squares and the cubes of the terms of an infinitely decreasing progression are also infinitely decreasing progressions. We therefore, have a system of equations

$$\begin{cases} \frac{a_1}{1-q} = 7/2, \\ \frac{a_1^2}{1-q^2} = 147/16, \end{cases}$$

solving which, we find $a_1 = 3$, $q = 1/7$ (for that purpose, it is sufficient to square the first equation and divide it by the second equation). Substituting now the values of a_1 and q obtained into the formula $a_i^3 / (1 - q^3)$, we get the answer. 36. $100/3$. 37. $(3\sqrt{3} - 1) / (2\sqrt{3})$ or $-(3\sqrt{3} + 1) / (2\sqrt{3})$. 38. 405, -270, 180, ... 39. $2/3$. 40. 27 or 3. 41. 2; 5; 8. 42. 7; 14; 21. 43. 2.5 or 22.5. 44. 931. 45. 4, 20, 100; $4/9$, $52/9$, $676/9$. 46. 4, 12, 36; $4/9$, -20/9, 100/9. 47. $2 \pm \sqrt{3}$. 48. 4, 20, 100 and 5, 20, 35; 100, 20, 4 and 101, 20, -61. 49. 5, 5, 5; $10/3$, 5, $15/2$. 50. 2. 51. 3, 6, 9, 12. 52. 1, 4, 16, 64. 53. 2, 5, 8, ...; 3, 6, 12, ... and $\frac{25}{2}, \frac{79}{6}, \frac{83}{6}, \dots, \frac{2}{3}, \frac{25}{3}, \frac{625}{6}, \dots$

5.2. Number Sequences

1. ▲ (a) Let us choose arbitrarily a positive number ε and show that we can find for it a natural N such that the inequality

$$|1/n - 0| < \varepsilon \quad (1)$$

holds for all numbers $n > N$. After transformations, we get an inequality $n > 1/\varepsilon$. If the number n is larger than $1/\varepsilon$, then inequality (1) holds true, i. e. we can take N equal to $[1/\varepsilon]$ where $[1/\varepsilon]$ is the integral part of the number $1/\varepsilon$. Thus, we have shown the existence of the number N such that inequality (1) holds for any $n > N = [1/\varepsilon]$ and have completed the proof. *Remark.* We can take as N any natural number exceeding $1/\varepsilon$; (b) ● Show that N can be taken equal to

$[(2 - \varepsilon)/\varepsilon]$, where $\varepsilon > 0$; (c) ● Make use of the proof of the assertion $\lim_{n \rightarrow \infty} q^n = 0$, $0 < q < 1$. 2. ▲ 1st method. The sequence (x_n) is said to be bounded if there are two numbers m and M such that the inequality $m \leq x_n \leq M$ holds true for any $n \in \mathbb{N}$. We shall prove the existence of the numbers m and M for the given sequence. All the terms of the sequence with the general term $(1 + (-1)^n)/n^2$ are nonnegative ($x_{2k-1} = 0$ for $n = 2k - 1$; $x_{2k} = \frac{2}{(2k)^2} = \frac{1}{2k^2}$ for $n = 2k$, $k \in \mathbb{N}$) and, therefore, we can take as m any negative number or zero (say, $m = -2$). Unity, for instance, can serve as M . Indeed, $x_{2k-1} = 0 < 1$ and $x_{2k} = \frac{1}{2k^2} < 1$ for any $k \in \mathbb{N}$. Consequently, $-2 \leq x_n \leq 1$ for any $n \in \mathbb{N}$ and this means that the given sequence is bounded.

2nd method. Since every convergent sequence is bounded (the necessary condition for the convergence of a sequence), we can infer, having established that $\lim_{n \rightarrow \infty} \frac{1+(-1)^n}{n^2} = 0$, that the

given sequence is bounded. 3. The sequences enumerated in (a), (b), (c), (e) and (h). 4. No, the sequence (x_n) , $x_n = (-1)^n$, for instance, is bounded, but it has no limit. 5. The sequence (x_n) is said to be unbounded if, for any number $L > 0$, there is at least

one number n such that $|x_n| > L$. 6. (a) ● Find $\lim_{n \rightarrow \infty} \frac{n+2}{n-1}$ and

$\lim_{n \rightarrow \infty} \frac{2-3n}{n^2+1}$; (b) ● Find $\lim_{n \rightarrow \infty} \left(\frac{1}{2}\right)^n$ and $\lim_{n \rightarrow \infty} \frac{n-1}{n^2-1}$. 7. No, in

general. For example, $x_n = (-1)^n$, $y_n = (-1)^{n+1}$. 8. (a) ● Find

$\lim_{n \rightarrow \infty} \frac{1-n+n^2}{n^2}$ and $\lim_{n \rightarrow \infty} \frac{1+5n^3}{n^3+3}$; (b) ● Find $\lim_{n \rightarrow \infty} \left(15 + \frac{1}{n^2}\right)$ and

$\lim_{n \rightarrow \infty} \frac{n-7}{n+6}$. 9. ▲ The limit of the sequence (x_n) , $x_n = cx_n$, where

c is a constant, exists: $\lim_{n \rightarrow \infty} cx_n = c_n \lim_{n \rightarrow \infty} x_n$. Setting $c = -1$, we

get $\lim_{n \rightarrow \infty} (-x_n) = -\lim_{n \rightarrow \infty} x_n = -a$. 10. ▲ Since $\lim_{n \rightarrow \infty} y_n = b$, it fol-

lows that $\lim_{n \rightarrow \infty} (-y_n) = -b$ (see the solution of the preceding prob-

lem). Applying the theorem on the limit of the sum of two convergent sequences, we obtain

$$\begin{aligned}
 \lim_{n \rightarrow \infty} (x_n + (-y_n)) &= \lim_{n \rightarrow \infty} x_n + \lim_{n \rightarrow \infty} (-y_n) \\
 &= \lim_{n \rightarrow \infty} x_n - \lim_{n \rightarrow \infty} y_n = a - b.
 \end{aligned}$$

11. (a) It diverges; (b) it can be either convergent or divergent. For example, (1) $a_n = 1/n$, $b_n = (-1)^n$; $\lim_{n \rightarrow \infty} a_n b_n = 0$, i.e. the sequence $a_n b_n$ converges; (2) $a_n = (n+1)/n$, $b_n = (-1)^n$, in this case the sequence $a_n b_n$ has no limit. 12. (a) No, we cannot; (b) no, we cannot.

For example, $a_n = (-1)^n$, $b_n = (-1)^{n+1}$, and then $a_n + b_n = 0$, $\lim_{n \rightarrow \infty} (a_n + b_n) = 0$; $a_n b_n = (-1)^{2n+1} = -1$ and $\lim_{n \rightarrow \infty} a_n b_n =$

$= -1$. 13. No, it does not. For example, $a_n = \frac{1+(-1)^n}{2}$, $b_n = \frac{1-(-1)^n}{2}$;

these two sequences are divergent. 14. The sequences enumerated in (a), (c), (d), (f), (h), (i). 15. \blacktriangle All terms of the sequence (x_n) , $x_n = \frac{5n}{n+2}$, are positive and, consequently, $x_n > 0$, and since $n/(n+2) < 1$, we have $5n/(n+2) < 5 \cdot 1$. Thus we have $0 < x_n < 5$ for any $n \in \mathbb{N}$, i.e. the given sequence is bounded. To prove the second assertion, we consider the difference

$$x_{n+1} - x_n = \frac{5(n+1)}{(n+1)+2} - \frac{5n}{n+2} = \frac{5 \cdot 2}{(n+3)(n+2)},$$

which is positive for any $n \in \mathbb{N}$ and, consequently, the given sequence increases. 16. \bullet Show that $1 < x_n < 1.5$ and that $x_{n+1} - x_n < 0$. 17. No, we cannot, for example, if $x_n = 1/n$, $y = (-1)^n n$, then the sequence $x_n y_n = (-1)^n$ has no limit. 18. 2. \blacktriangle Let us consider two sequences (x_n) and (y_n) ,

$$x_n = \frac{2n+1}{n+2} \text{ and } y_n = \frac{n-3}{n+4} \text{ and find their limits: } \lim_{n \rightarrow \infty} x_n =$$

$$= \lim_{n \rightarrow \infty} \frac{2n+1}{n+2} = \lim_{n \rightarrow \infty} \frac{n(2+1/n)}{n(1+2/n)} = \lim_{n \rightarrow \infty} \frac{2+1/n}{1+2/n} = \lim_{n \rightarrow \infty} \frac{2+0}{1+0} = 2$$

(since $\lim_{n \rightarrow \infty} \frac{1}{n} = 0$ and $\lim_{n \rightarrow \infty} \frac{2}{n} = 0$). By analogy, we find the

limit of the sequence y_n : $\lim_{n \rightarrow \infty} y_n = 1$. Applying then the theorem

on the limit of the product of two convergent sequences, we get

the answer. 19. 0. \bullet Reduce the expression $\frac{5n^3-4}{n^4+6}$ to the form

$$\frac{1}{n} \cdot \frac{5-4/n^3}{1+6/n^3} \text{ and apply the theorem on the limit of the product}$$

of an infinitely small sequence by a bounded sequence. 20. $-5/3$.

21. $1/5$. 22. $1/27$. 23. $-3/4$. 24. 0. \bullet Reduce the expression

$$\frac{n \sin n}{n^2+1} \text{ to the form } \frac{1}{n} \cdot \frac{\sin n}{1+1/n^2} \text{ and show that the sequence}$$

$$\left(\frac{\sin n}{1+1/n^2} \right) \text{ is bounded. 25. 4. 26. 0. } \bullet \frac{n!}{(n+1)! - n!} =$$

$$= \frac{n!}{n!(n+1) - n!} = \frac{n!}{n!(n+1-1)} = \frac{1}{n}. 27. 0. 28. 1. 29. 3/4. 30. 3/2.$$

$$\bullet 1+2+3+\dots+n = n(n+1)/2. 31. 4/3. \bullet 1^2+2^2+\dots+n^2 =$$

$$n(n+1)(2n+1)/6. 32. (a) 1. \bullet \frac{1}{n(n+1)} = \frac{1}{n} - \frac{1}{n+1}; (b) 1/2;$$

(c) $1/2$. \bullet Use the results of the preceding problems (a) and (b) and apply the theorem on the limit of the difference of two convergent sequences. 33. 1 if $|b| > 1$; 0 if $|b| = 1$; -1 if $0 < |b| < 1$.

Chapter 6

ELEMENTS OF VECTOR ALGEBRA

6.1. Linear Operations on Vectors

1. (a) The vectors \mathbf{a} and \mathbf{b} must be mutually perpendicular; (b) the angle between the vectors \mathbf{a} and \mathbf{b} must be acute; (c) the angle between the vectors \mathbf{a} and \mathbf{b} must be obtuse. 2. (a) π ; (b) $1/10$. 3. $x \in (-1; 5)$. ● The original inequality is equivalent to the inequality $|x - 2| \times |x + 1| < 3|a|$ or $|x - 2| < 3$. 4. $x \in (-3; -1] \cup [1; \infty)$. ● Solve the system of inequalities

$$\begin{cases} |x| \geq 1, \\ x + 3 > 0. \end{cases}$$

5. $x = 10/7$, $y = 4/7$. 6. 0. ▲ By the hypothesis, $\mathbf{a} + \mathbf{b} = \lambda \mathbf{c}$ and $\mathbf{b} + \mathbf{c} = \mu \mathbf{a}$, where λ, μ are some numbers different from zero. Excluding \mathbf{b} from these equations, we arrive at an equality $(\mu + 1)\mathbf{a} = (\lambda + 1)\mathbf{c}$, which is only possible for $\mu = -1$ and $\lambda = -1$ (the vectors \mathbf{a} and \mathbf{c} are noncollinear). Consequently, $\mathbf{a} + \mathbf{b} = -\mathbf{c}$ and $\mathbf{a} + \mathbf{b} + \mathbf{c} = 0$. 7. $p = 1$, $q = 1$. ▲ It follows from the collinearity of the vectors $p\mathbf{a} + q\mathbf{b} + \mathbf{c}$ and $\mathbf{a} + p\mathbf{b} + q\mathbf{c}$ that $(p - \lambda)\mathbf{a} + (q - p\lambda)\mathbf{b} + (1 - \lambda q)\mathbf{c} = 0$. The last equality is only possible when $p - \lambda = 0$, $q - p\lambda = 0$, $1 - \lambda q = 0$ ($\lambda \neq 0$). Solving the system of these equations, we get the answer. 8. It is true if $|\mathbf{a}| > |\mathbf{b} + \mathbf{c}|$. 9. $\vec{AO} = (\mathbf{a} + \mathbf{b})/3$. 10. $(2/3)(\mathbf{a} + \mathbf{b})$. ▲ We have $\vec{AC} = \vec{AB} + \vec{AD}$,

$$\vec{AB} + \vec{BM} = \vec{AB} + \frac{1}{2}\vec{AD} = \mathbf{a}, \quad (1)$$

$$\vec{AD} + \vec{DK} = \vec{AD} + \frac{1}{2}\vec{AB} = \mathbf{b}. \quad (2)$$

Adding together equations (1) and (2), we obtain

$$\frac{3}{2}(\vec{AB} + \vec{AD}) = \frac{3}{2}\vec{AC} = \mathbf{a} + \mathbf{b}, \text{ whence } \vec{AC} = \frac{2}{3}(\mathbf{a} + \mathbf{b}).$$

11. $|\mathbf{a}| = |\mathbf{b}|$. 12. $\frac{|\mathbf{b}|\mathbf{a} + |\mathbf{a}|\mathbf{b}}{\|\mathbf{b}|\mathbf{a} + |\mathbf{a}|\mathbf{b}\|}$. 13. (a) 13; (b) $\sqrt{109}$.

14. $\{(-5/4; 8/5)\}$ 15. $\mathbf{p} = (-6; 8)$. 16. $\mathbf{p} = 2\mathbf{a} - 3\mathbf{b}$. Since the vectors \mathbf{p} , \mathbf{a} and \mathbf{b} are coplanar, we have $\mathbf{p} = \lambda\mathbf{a} + \mu\mathbf{b}$. The last equation can be rewritten in the form $\mathbf{p} = (3; 4) = \lambda(3; -1) + \mu(1; -2)$. Hence we get a system of equations with respect to λ and μ :

$$\begin{cases} 3 = 3\lambda + \mu, \\ 4 = -\lambda - 2\mu, \end{cases}$$

solving which, we get: $\lambda = 2$, $\mu = -3$; consequently, $\mathbf{p} = 2\mathbf{a} - 3\mathbf{b}$. 17. $\{(2; 9); (7; 0)\}$; ● Consider separately the cases $(BC) \parallel (AD)$ and

$(AB) \parallel (CD)$. 18. $(1.5; 1; -2)$. 19. ● Show that $\vec{CD} = -2\vec{AB}$. 20. $\sqrt{18}$. 21. (a) $(4\sqrt{2}; -2; 8)$, $(-4\sqrt{2}; 2; -8)$; (b) $(-24; 32; 30)$; (c) $(-6; 8; 24)$. 22. $M(-1; 0; 0)$. ● Use the equality $|\vec{MA}| = |\vec{MB}|$, where $\vec{MA} = (1-x; 2; 3)$ and $\vec{MB} = (-3-x; 3; 2)$. 23. $\sqrt{51}/3$. ● $\vec{AO} = \vec{AB} + (1/3)(\vec{BC} + \vec{BD})$. 24. Yes, they are. 25. $d = 2a - 3b + c$. ● Represent the vector d in the form $d = \lambda a + \mu b + \nu c$ and from the system of equations

$$\begin{cases} 3\lambda - \mu + 2\nu = 11, \\ -2\lambda + \mu + \nu = -6, \\ \lambda - 2\mu - 3\nu = 5 \end{cases}$$

find the coefficients λ, μ, ν . 26. $\frac{2}{5}\vec{AA_1} + \frac{2}{5}\vec{AB} + \frac{3}{5}\vec{AC}$. ● $\vec{AM} = \vec{AC} + \frac{2}{5}\vec{CB_1}$. 27. $\frac{4}{13}\mathbf{i} + \frac{3}{13}\mathbf{j} + \frac{12}{13}\mathbf{k}$. ▲ We have $\vec{AC_1} = \vec{AD} + \vec{AB} + \vec{AA_1} = 4\mathbf{i} + 3\mathbf{j} + 12\mathbf{k}$; consequently, $|\vec{AC_1}| = \sqrt{4^2 + 3^2 + 12^2} = 13$ and $\mathbf{e} = \frac{\vec{AC_1}}{|\vec{AC_1}|} = \frac{4}{13}\mathbf{i} + \frac{3}{13}\mathbf{j} + \frac{12}{13}\mathbf{k}$. 28. 3:1.

● Prove that the required ratio is equal to the ratio of the lengths of the vectors \vec{EC} and \vec{EM} , (E being the midpoint of the segment BD). 29. 5. ▲ We introduce the rectangular basis $Oxyz$ by superimposing O with the point

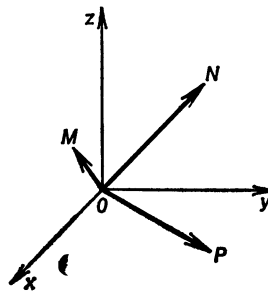

of application of the forces (see the figure), with $\vec{OM} \in Oxz$, $\vec{ON} \in Oyz$ and $\vec{OP} \in Oxy$. Suppose $|\vec{OM}| = 1$, $|\vec{ON}| = 2$ and $|\vec{OP}| = 3$, then $\vec{OM} = (1/\sqrt{2}; 0; 1/\sqrt{2})$, $\vec{ON} = (0; \sqrt{2}; \sqrt{2})$ and $\vec{OP} = (3/\sqrt{2}; 3/\sqrt{2}; 0)$. The sum of these vectors is the vector of the resultant of these forces $\mathbf{p} = (4/\sqrt{2}; 5/\sqrt{2}; 3/\sqrt{2})$; $|\mathbf{p}| = \sqrt{\frac{16+25+9}{2}} = 5$. 30. $\alpha^2 + \beta^2 = 1$.

6.2. The Scalar Product of Vectors

1. $3\pi/4$. 2. 4. 3. $3/\sqrt{21}$. ▲ We have $(\mathbf{a} + \mathbf{b}) \cdot (\mathbf{a} - \mathbf{b}) = |\mathbf{a} + \mathbf{b}| |\mathbf{a} - \mathbf{b}| \cos \varphi$; hence

$$\cos \varphi = \frac{|\mathbf{a}|^2 - |\mathbf{b}|^2}{\sqrt{(\mathbf{a} + \mathbf{b})^2} \sqrt{(\mathbf{a} - \mathbf{b})^2}}$$

$$\begin{aligned}
&= \frac{2^2 - 1}{\sqrt{2^2 + 1^2 + 2 \cdot 2 \cdot 1 \cdot \cos 60^\circ} \sqrt{2^2 + 1^2 - 2 \cdot 2 \cdot 1 \cdot \cos 60^\circ}} \\
&= \frac{3}{\sqrt{3} \cdot \sqrt{7}} = \frac{3}{\sqrt{21}}.
\end{aligned}$$

4. $-4/5$. \blacktriangle Solving the system of equations with respect to \mathbf{p} and \mathbf{q} , we find: $\mathbf{p} = (1/3)(2\mathbf{a} - \mathbf{b}) = (1/3; 1)$, $\mathbf{q} = (1/3)(2\mathbf{b} - \mathbf{a}) = (1/3; -1)$;

since $\mathbf{pq} = |\mathbf{p}| |\mathbf{q}| \cos(\widehat{\mathbf{p}, \mathbf{q}})$, we have $\cos(\widehat{\mathbf{p}, \mathbf{q}}) = (1/9 - 1) / (\sqrt{10/9})^2 = -4/5$. 5. \bullet Prove that $\mathbf{ap} = 0$. 6. -295 . \blacktriangle Squaring the equality $\mathbf{a} + \mathbf{b} + \mathbf{c} = 0$, we get $|\mathbf{a}|^2 + |\mathbf{b}|^2 + |\mathbf{c}|^2 + 2(\mathbf{ab} + \mathbf{bc} + \mathbf{ca}) = 0$. Hence we have $\mathbf{ab} + \mathbf{bc} + \mathbf{ca} = -(|\mathbf{a}|^2 + |\mathbf{b}|^2 + |\mathbf{c}|^2)/2 = -(13^2 + 14^2 + 15^2)/2 = -295$.

7. $\arccos(1/3)$. \bullet Determine the angle between the vectors \vec{AB} and \vec{AC} . 8. $\pi/4$. 9. $\arccos(5/\sqrt{39})$. \bullet Find the angle between the vectors \vec{AB} and \vec{BC} .

$$10. \alpha = \arccos \frac{2z-5}{3\sqrt{(z-3)^2+2}}. \quad 11. 9/2. \quad \bullet \quad S_{ABC} = \frac{1}{2} |\vec{AB}| |\vec{AC}| \times$$

$$\times \sin \hat{A}, \quad \sin \hat{A} = \sqrt{1 - \cos^2 \hat{A}} = \sqrt{1 - \left(\frac{|\vec{AB} \cdot \vec{AC}|}{|\vec{AB}| |\vec{AC}|} \right)^2}.$$

12. $\arccos\left(-\sqrt{\frac{3}{10}}\right)$. \bullet Show that the required angle is equal

to the angle between the vectors $\vec{AB} + \vec{BC}$ and $\vec{BC} - \vec{AB}$. 13. $\arccos \times (63/\sqrt{6441})$.

14. $|\vec{AC}| = 5$; $O(5/2; 1; 1)$. 15. $(1; 1/2; -1/2)$. \blacktriangle Suppose $\mathbf{b} = (x, y, z)$. Then it follows, from the condition of collinearity, that $x/2 = y/1 = -z/1 = t$ or $x = 2t$, $y = t$, $z = -t$. Substituting the last equality into the scalar product $\mathbf{ab} = 3$, we find that $t = 1/2$. 16. $(-3; 3; 3)$. 17. $(4/\sqrt{3}); -1/\sqrt{3}; -2/\sqrt{3}$. 18. $(2; -3; 0)$. 19. $(1; 0; 1); (-1/3; 4/3; -1/3)$. \blacktriangle If we suppose that $\mathbf{c} = (x; y; z)$, then we get

$$|\mathbf{c}| = |\mathbf{a}| = |\mathbf{b}| = \sqrt{2} = \sqrt{x^2 + y^2 + z^2}. \quad (1)$$

By the hypothesis, the angles φ between the vectors are identical and, therefore,

$$\cos \varphi = \frac{\mathbf{ab}}{|\mathbf{a}| |\mathbf{b}|} = \frac{1}{2} \quad \text{and} \quad \frac{\mathbf{ac}}{|\mathbf{a}| |\mathbf{c}|} = \frac{x+y}{2} = \frac{1}{2} \quad (2)$$

and

$$\frac{\mathbf{bc}}{|\mathbf{b}| |\mathbf{c}|} = \frac{y+z}{2} = \frac{1}{2}. \quad (3)$$

Solving the system of equations (1), (2), (3), we get the answer. 20. 5. 21. $(2; -2; -2)$. 22. $x \in (-\infty; 0)$. \bullet Find the values of x for which the inequalities $\mathbf{ab} > 0$, $\mathbf{bc} < 0$, where $\mathbf{c} = (0; 1; 0)$, hold si-

multaneously. 23. ● Find $\vec{MQ} \cdot \vec{NP}$, where $\vec{MQ} = \vec{MP} + \vec{PQ}$, $\vec{NP} = \vec{NQ} + \vec{QP}$.
 24. $\arccos(-4/5)$. ▲ In the isosceles right triangle ABC (see the figure) we have $|\vec{AC}| = |\vec{AB}|$, $[BM_1]$ and $[CM_2]$ being the medians,

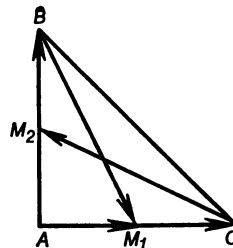

$$\vec{BM}_1 = \frac{1}{2} \vec{AC} - \vec{AB},$$

$$\vec{CM}_2 = \frac{1}{2} \vec{AB} - \vec{AC}.$$

Multiplying scalarly the two last vector equalities and taking into account that $\vec{AB} \perp \vec{AC}$, we find

$$\vec{BM}_1 \cdot \vec{CM}_2 = \frac{5}{4} |\vec{AB}|^2 \cos \varphi = -(\vec{AC}^2 + \vec{AB}^2)/2 = -|\vec{AB}|^2.$$

25. $\vec{BM} = \frac{bc}{|c|^2} \cdot c - b$. ▲ We have (see the figure)

$$\vec{BM} = \vec{AM} - b, \quad (1)$$

where $\vec{AM} = \gamma c$ (γ being some real number).

Since the vector \vec{BM} is perpendicular to the

vector c , we have $\vec{BM} \cdot c = 0$. Consequently,

$\gamma c^2 - b \cdot c = 0$, i.e. $\gamma = b \cdot c / |c|^2$. Substituting the obtained γ into

equation (1), we get the answer. 26. $(-20/7; -30/7; 10/7)$. ● Use the

solution of problem 25. 27. $\arccos(2/\sqrt{29})$. ● Using the result of

problem 25, we find

$$\vec{BM}_1 = \left(\frac{14}{9}; \frac{1}{9}; -\frac{8}{9} \right), \quad \vec{DM}_2 = (2; -2; 1);$$

$$\cos \psi = \frac{\vec{BM}_1 \cdot \vec{DM}_2}{|\vec{BM}_1| |\vec{DM}_2|}.$$

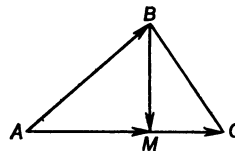

28. $2x + 2y + 3z - 6 = 0$. ▲ The equation of a plane, in its general form, is

$$ax + by + cz + d = 0. \quad (1)$$

Substituting, in turn, the coordinates of the points M_1, M_2, M_3 into equation (1), we obtain a system of equations

$$\begin{cases} a - b + 2c = -d, \\ 3b = -d, \\ 2a + b = -d, \end{cases}$$

solving which, we find $a = -d/3, b = -d/3, c = -d/2$. For these values of the coefficients a, b and c equation (1) assumes the form

$-d(2x + 2y + 3z - 6) = 0$. Cancelling by $(-d)$ ($d \neq 0$), we get the required equation. 29. $x + z - 4 = 0$. \blacktriangle Suppose $\mathbf{n} = (a; b; c)$ is a vector normal to the plane α passing through the point $A(4; 0; 0)$. Since the plane α is parallel to the y -axis, the vector \mathbf{n} is perpendicular to any vector, which is parallel to the y -axis, say, to the vector $\mathbf{j} = (0; 1; 0)$. Hence it follows that $\mathbf{n}\mathbf{j} = b = 0$, i.e. the equation of the plane α has the form $a(x - 4) + cz = 0$ or $a_1(x - 4) + z = 0$, where $a_1 = a/c$. Substituting the coordinates of the point B into the last equation, we get $a_1(0 - 4) + 4 = 0$, $a_1 = 1$, whence it follows that $x + z - 4 = 0$. 30. -1. \blacktriangle If $D \in (ABC)$, then the vectors \vec{AB} , \vec{AC} , \vec{AD} are coplanar and, therefore, $\vec{AD} = \lambda\vec{AB} + \mu\vec{AC}$, where at least one of the coefficients (λ, μ) is nonzero. In the coordinate form, this equation can be written as $(k - 1; 2; 2) = \lambda(-2; 3; 1) + \mu(0; 2; -2)$. From this we get a system of equations

$$\begin{cases} -2\lambda = k - 1, \\ 3\lambda + 2\mu = 2, \\ \lambda - 2\mu = 2, \end{cases}$$

from which we find that $\lambda = 1$ and $k = -2\lambda + 1 = -2 + 1 = -1$. *Remark.* We can also solve the problem by first writing the equation of the plane (ABC) (see the solution of problem 28) and then substituting into that equation the coordinates of the point D . 31. \bullet (a) See the solution of problem 30; (b) $\pi/2$; (c) $21\sqrt{10}/2$. $\bullet S_{ABCD} = (1/2)|\vec{AC} \times \vec{BD}|$. 32. $\pi/3$. \bullet To find the angle between the planes (ABC) and (ABD) , determine the angle between the vectors \mathbf{n}_1 and \mathbf{n}_2 , which are normal to the planes (ABC) and (ABD) . 33. (a) $A(1; 2; 0)$; $B(0; 0; 2)$. \blacktriangle Setting $z = 0$ in the system of equations

$$\begin{cases} 2x + 3y + 4z - 8 = 0, \\ 4x + y + 3z - 6 = 0, \end{cases} \quad (1)$$

we find the abscissa and the ordinate of the point A of intersection of the straight line p and the plane xOy , i.e. we find that $x = 1$ and $y = 2$. Similarly we find the coordinates of the point B (we must put $x = 0$ in system (1)); (b) $\arcsin(2/3)$. \bullet We can calculate the required angle

from the equality $\cos \varphi = \frac{|\vec{BA} \cdot \mathbf{n}|}{|\vec{BA}| |\mathbf{n}|}$, where $\vec{BA} = (1; 2; -2)$ and $\mathbf{n} = (0; 1; 0)$ is a vector normal to the plane xOz (φ is the angle between the vectors \vec{BA} and \mathbf{n}). 34. (a) $E(12; 0; 3)$; $F_1(0; 6; 12)$; $G(6; 12; 0)$; (b) $7x + 5y + 6z - 102 = 0$; (c) $3\sqrt{10/11}$. \bullet The equation of the straight line passing through the point B_1 at right angles to the plane (EF_1G) has the form $\frac{x-0}{7} = \frac{y-0}{5} = \frac{z-12}{6}$ (the vector $(x; y; z - 12)$ being collinear with the vector $(7; 5; 6)$). Determine the coordinates of the point M of intersection of that line and the plane (EF_1G) and find the distance $|B_1M|$ by the formula $|B_1M| = \sqrt{(x_{B_1} - x_M)^2 + (y_{B_1} - y_M)^2 + (z_{B_1} - z_M)^2}$.

Chapter 7

PLANE GEOMETRY

7.1. Problems on Proving Proportions

1. \blacktriangle (1) $C \in [AB]$. Supposing that $C \in [AM]$, we have

$$\begin{aligned} |AC| + |CM| &= |AM| \text{ and } |BC| = |CM| + |MB| = \\ &= |CM| + |AM|. \end{aligned}$$

Excluding $|AM|$ from these equalities, we find that $|CM| = \frac{1}{2}(|AC| + |BC|)$. By analogy, we can consider the case when $C \in [MB]$; (2) $C \notin [AB]$. Suppose $C \in [BD]$, where $D \in (AB)$.

Then $|MC| = |MB| + |BC|$ and $|AC| = |AM| + |MC| = |MB| + |MC|$. Excluding $|MB|$ from these equalities, we find that $|MC| = \frac{1}{2}(|AC| + |BC|)$. The case when $C \in [A, E)$, where $E \in (AB)$, can be treated by analogy. 2. \bullet Use the property of vertical angles. 3. \blacktriangle Draw $(AF) \perp (CD)$ (see the figure). The straight line (AF) is the axis of symmetry of the triangle ACD and cuts $[BD]$ at a point O . Hence, it follows that $|OC| = |OD|$. From the inequality of the triangles we find that $|OB| + |OC| > |BC|$, but $|OB| + |OC| = |OB| + |OD| = |BD|$ and, therefore, $|BD| > |BC|$. 4. \bullet Use the property of alternate angles at parallel straight lines.

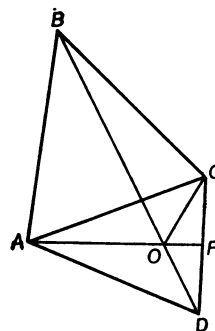

5. \blacktriangle The segments $[KL]$ and $[MN]$ (see the figure) are the midlines of the triangles ABC and ADC ; consequently, $[KL] \parallel [AC] \parallel [MN]$. We can similarly prove that $[KN] \parallel [LM]$, and this means that $KLMN$ is a parallelogram.

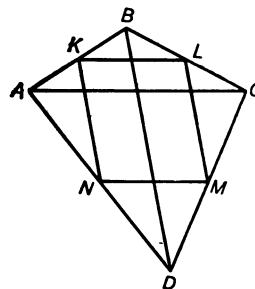

6. \blacktriangle Let us draw the midline $[MN]$ of the trapezoid $ABCD$ (see the figure). It cuts the diagonals AC and BD of the trapezoid at points E and F , which are the midpoints of the respective diagonals (which follows from the Thales theorem for the angles BAC and BDC). Consequently, $[EF] \parallel [AD]$. Next we find the length of the segment $[EF]$; $[MF]$ is the median of the triangle ABD , $[ME]$ is the median of the

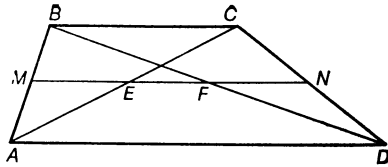

triangle ABC and, therefore, it follows from the equation $|MF| = |ME| + |EF|$, or $a/2 = |EF| + b/2$, that $|EF| = (a - b)/2$.

7. \blacktriangle Suppose $[CF]$ is the bisector of the angle BCD , $[DP]$ is the bisector of the angle ADC (see the figure).

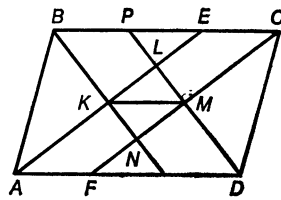

Since $\widehat{BCD} + \widehat{ADC} = \pi$, we have $\widehat{FCD} + \widehat{MDC} = \pi/2$, and hence it follows that $\widehat{CMD} = \pi/2$ and, there-

fore, $\widehat{LMN} = \pi/2$. (The angle CMD and LMN are vertical). We can prove by analogy that $\angle LKN$ is a right angle, and since $(AE) \parallel (CF)$, we infer that $KLMN$ is a rectangle.

Let us now find the length of the diagonal $[KM]$. The triangles ABE and CDF are congruent ($|AB| = |CD|$, $\angle B = \angle D$, $|BE| = |DF|$; the last equality follows from the fact that the bisectors BK and DM of the triangles in question are the altitudes of those triangles, and this means that $|AB| = |BE| = |CD| = |DF|$).

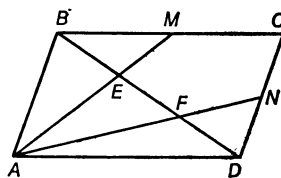

It follows from the congruence of those triangles that $|KE| = |MC|$ and so $KECM$ is a parallelogram. Consequently, $|KM| = |EC| = |BC| - |BE| = |BC| - |AB|$.

8. \blacktriangle Suppose E and F are the points of intersection of the straight lines (AM) and (AN) with the diagonal BD (see the figure). It follows from the similarity of the triangles AFB and DFN (the angles AFB

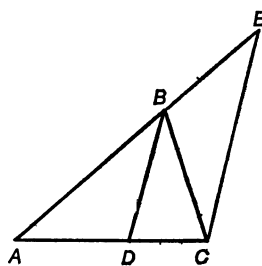

and DFN being vertical, $\widehat{FND} = \widehat{BAF}$, that $\frac{|DF|}{|BF|} = \frac{|DN|}{|AB|} = \frac{1}{2}$. Thus, $|DF| = (1/3)|BD|$.

By analogy (consider the similarity of the triangles BEM and AED) we find that $|BE| = (1/3)|BD|$, and, consequently, $|EF| = (1/3)|BD|$ as well, i.e. $|BE| = |EF| = |FD|$. 9. \blacktriangle Let us draw $(CE) \parallel (BD)$ (BD being the bisector), $E = (AB) \cap (CE)$ (see the figure):

Hence we get $|BE| = |BC|$ ($\widehat{ABD} = \widehat{BEC} = \widehat{DBC} = \widehat{BCE}$ and, therefore, the triangle CBE is isosceles). Furthermore, we have $\frac{|AB|}{|AD|} = \frac{|BE|}{|CD|}$ or $\frac{|AB|}{|AD|} = \frac{|BC|}{|CD|}$. 10. \blacktriangle From the similarity of the triangles ABD and MBO (see the figure) we have $\frac{|OM|}{|AD|} = \frac{|OB|}{|DB|}$, and from the similarity of the triangles ACD

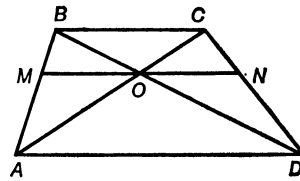

and OCN we have $\frac{|ON|}{|AD|} = \frac{|OC|}{|AC|}$. But $\frac{|OC|}{|AC|} = \frac{|OB|}{|DB|}$ since $\triangle BOC \sim \triangle AOD$ ($\frac{|AC|}{|OC|} = 1 + \frac{|AO|}{|OC|}$, $\frac{|DB|}{|OB|} = 1 + \frac{|OD|}{|OB|}$) and, therefore, $\frac{|OM|}{|AD|} = \frac{|ON|}{|AD|}$ or $|OM| = |ON|$.

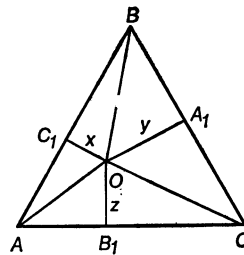

11. Suppose O is an arbitrary point lying in the interior of a regular triangle ABC (see the figure), and assume that $|OC_1| = x$, $|OA_1| = y$, $|OB_1| = z$, $|AB| = a$. We seek the area of the triangle ABC as the sum of the areas of the triangles AOB , BOC , AOC :

$$S_{ABC} = \frac{1}{2}xa + \frac{1}{2}ya + \frac{1}{2}za; \text{ on the other hand, } S_{ABC} = a^2 \sqrt{3}/4.$$

We have an equality $a^2 \sqrt{3}/4 = \frac{1}{2}a(x+y+z)$ or $x+y+z = a\sqrt{3}/2 = h$, where h is the length of the altitude of the triangle ABC .

12. \blacktriangle Suppose $|BC| = a$, $|AC| = b$, $|AB| = c$ (see the figure). Then $S = S_{ABC} = S_{AOB} +$

$$+ S_{BOC} + S_{AOC} = \frac{1}{2}|OA_1|a + \frac{1}{2}|OB_1|b + \frac{1}{2}|OC_1|c; \text{ and}$$

since $|OC_1| = |OA_1| = |OB_1| = r$,

$$\text{it follows that } S = r \frac{a+b+c}{2} =$$

$$= rp, \text{ whence we find that } r = S/p.$$

13. \blacktriangle The area S of the triangle ABC can be found by the formula $S = (1/2)ab \sin \hat{C}$, where \hat{C} is the magnitude of the angle opposite to the side AB . We draw the diameter AC_1 of the circle

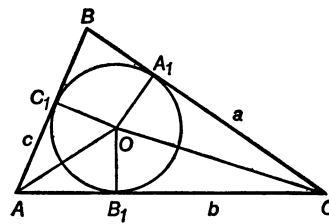

circumscribed about the triangle ABC . The angles $\widehat{BC_1A}$ and \widehat{ACB} , inscribed into that circle, are such that $\sin \widehat{C} = \sin \widehat{C_1}$ and, therefore, $|AB| = c = 2R \sin \widehat{C}$. Consequently, $\sin \widehat{C} = \frac{c}{2R}$ and $S = \frac{1}{2} ab \frac{c}{2R}$,

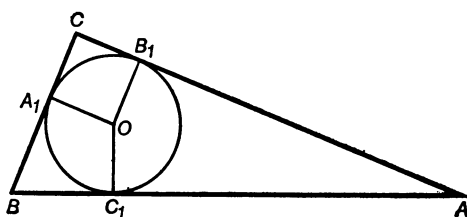

whence it follows that $R = \frac{abs}{4S}$. 14. \blacktriangle Using the property of the segments of tangents to a circle drawn from the same point, we have:

$|A_1C| = |CB_1| = r$ (A_1CB_1O being a square), $|A_1B| = |BC_1|$ and $|B_1A| = |AC_1|$ (see the figure). Hence we find that $|BC| = |A_1B| + r$, $|AC| = |AB_1| + r$ (r being the radius of the inscribed circle). Adding these equalities together, we get

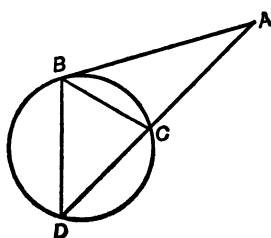

$$\begin{aligned} |BC| + |AC| &= \\ &= 2r + |A_1B| + |AB_1| = \\ &= 2r + |BC_1| + |C_1A| = 2r + |AB|, \end{aligned}$$

and since the length of the hypotenuse of a right triangle is equal to the diameter of the circle circumscribed about that triangle, it follows that $|BC| +$

$|AC| = 2r + 2R$. 15. \blacktriangle Let us connect the point B with the points C and D by line segments (see the figure). The triangles

ABC and ABD are similar ($\widehat{ABC} = \widehat{ADB}$, the angle A being common)

and, therefore, $\frac{|AB|}{|AC|} = \frac{|AD|}{|AB|}$, whence it

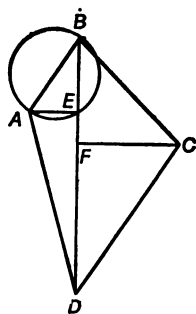

follows that $|AB|^2 = |AD| \cdot |AC|$.

16. \blacktriangle Suppose $ABCD$ is a convex quadrangle (see the figure). We draw perpendiculars from the vertices A and C to the diagonal BD and obtain four right triangles AEB , BFC , CFD and AED . All the points of the triangle AEB belong to the circle constructed on the side AB as a diameter ($\angle E = \pi/2$, the angle being inscribed). Presenting similar arguments for the other three triangles, we infer that any point of the quadrangle belongs to at least one of the circles whose diameters are the sides of the quadrangle $ABCD$. 17. \bullet

Prove that $\widehat{MPN} = \widehat{MFH}$, $\widehat{PNQ} = \widehat{PMQ}$. 18. \blacktriangle Rotation of the triangle DBF about the point B through the angle of 90° (see the

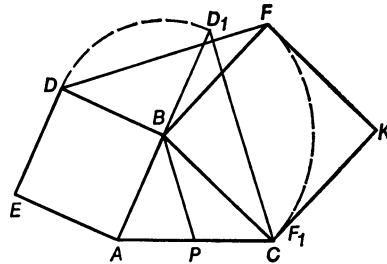
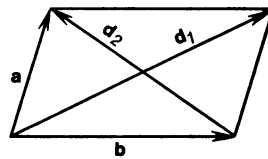

figure) carries the point D into the point D_1 and the point F into the point F_1 coinciding with the point C . At the same time, $|D_1C| = |DF|$, and $D_1 \in (AB)$. Since $|AB| = |BD| = |BD_1|$ (as the lengths of the sides of a square) and $|AP| = |PC|$ (by the hypothesis), it follows that $[BP]$ is the median of the triangle AD_1C , and this means

that $|BP| = \frac{1}{2} |D_1C| = \frac{1}{2} |DF|$ or

$|DF| = 2|BP|$. 19. \bullet Prove that under the homothetic transformation with centre $O = [AC] \cap [BD]$ with the ratio of similitude $k = -|CD|/|AB|$, the square constructed on $[AB]$ will go into a square constructed on $[CD]$. 20. \blacktriangle



Since $d_1 = a + b$ and $d_2 = a - b$ (see the figure), we can square these equalities and add them together to obtain

$$\begin{aligned} |d_1|^2 &= |a|^2 + |b|^2 + 2a \cdot b, \\ |d_2|^2 &= |a|^2 + |b|^2 - 2a \cdot b, \\ d_1^2 + d_2^2 &= 2(a^2 + b^2). \end{aligned}$$

7.2. Construction Problems

1. \bullet Construct a parallelogram such that point A is the intersection of the diagonals.
2. \bullet Construct a triangle with sides $a, b, 2m$, where a, b, m are the lengths of the given sides and the median, respectively.
3. \blacktriangle Having constructed a point B_1 (see the figure), symmetric with respect to the point B about p , and having connected it by a straight line with the point A , we get a point $C \in p \cap (AB_1)$, which satisfies the requirements of the problem, since the inequality $|BC| + |AC| = |B_1C| + |AC| = |AB_1| < |B_1C_1| + |AC_1|$ is satisfied for any

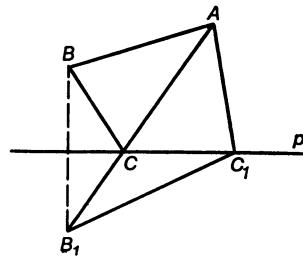

other point $C_1 \in p$. 4. \blacktriangle Let us take points A_1 and C_1 on the sides of the angle ABC (see the figure) and construct the bisectors of the angles A_1 and C_1 of the triangle A_1BC_1 , which meet at a point O_1 .

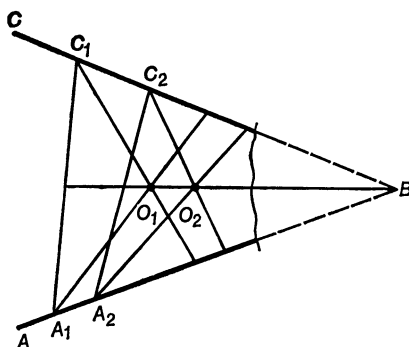

Since the bisectors of a triangle meet at the same point, the point O_1 belongs to the bisector of the angle B .

By analogy, we find a point O_2 , which is the intersection point of the bisectors in the triangle A_2BC_2 . The straight line (O_1O_2) is the required line since it contains the bisector of the angle B . 5. \bullet Construct a triangle A_1BC_1 ($A_1 \in (AB)$, $C_1 \in (BC)$), such that the point D is the intersection point of the altitudes. 6. \bullet Construct a triangle using three sides whose lengths constitute $2/3$ of the lengths of the given medians and prove that the doubled lengths of the medians of the resulting triangle are the sides of the required triangle. 7. (a) \bullet Prove that if $|AB| = a$, $|BC| = b$ (see the figure) and the radius of the semicircle $|AO| = (a+b)/2$, then $|DB| = \sqrt{ab}$ ($[DB] \perp [AC]$).

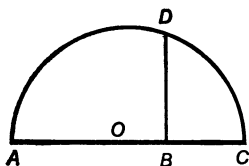

(b) \bullet Construct the line segments $c = |a - b|$ and $d = \sqrt{ab}$ and then the segment $x = \sqrt{a^2 - ab + b^2} = \sqrt{(a-b)^2 + ab} = \sqrt{c^2 + d^2}$ (as the hypotenuse of a right triangle with legs of lengths c and d).

(c) \bullet Construct the line segments $c = |a - b|$ and $d = b\sqrt{3}$ and then the required segment $x = \sqrt{c^2 + d^2}$. 8. \bullet Construct an arbitrary triangle ABC from the given angles \hat{A} and \hat{B} , find its perimeter p and consider the triangle $A_1B_1C_1$, homothetic to the triangle ABC , with the ratio of similitude $k = p_1/p$, where p_1 is the perimeter of the required triangle with centre at the vertex A (or at the vertices B or C). Prove that $A_1B_1C_1$ satisfies all the conditions of the problem.

9. \bullet Prove that the ratio of the radii of the circles circumscribed about similar triangles is equal to the ratio of the similar sides. 10. (a) \bullet Using the segment $[OA]$ as a diameter, construct a circle and prove that the straight lines passing through the point A and the intersection points of the circles are tangents to the given circle. (b) \bullet To find the segment $|AC|$, use the equation $|AK|^2 = |AC| \cdot |AB|$, where

AK] is a segment of the tangent drawn from the point A to the given circle (K being the point of tangency) (see problem 15 in 7.1). 11. ● Find the radii R_1, R_2, R_3 of the circles from the system of equations

$$\begin{cases} R_1 + R_2 = a, \\ R_2 + R_3 = b, \\ R_3 + R_1 = c, \end{cases}$$

where a, b, c are the lengths of the sides of the given triangle. 12. (a) ▲ We draw a straight line (AB) (see the figure); $K = (AB) \cap p$. Using

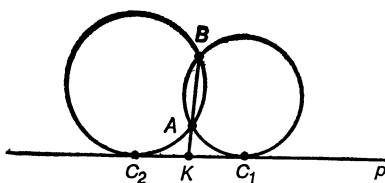

the equation $|KC|^2 = |KB| \cdot |AK|$ to construct the segment $|KC|$ (see the solution of problem 10b of this section) and laying off that segment on both sides of the point K , we get two points C_1 and C_2 . The circles passing through the points A, B, C_1 and A, B, C_2 are the required circles. *Remark.* If $[AB] \parallel p$, then there is only one circle satisfying the requirements of the problem. (b) ● Prove that this property is inherent in the following points: the point of tangency of the circle of the smaller radius, if $[AB] \nparallel p$; points C_1 and C_2 of tangency of two circles of the same radius, if $[AB] \perp p$; the point of tangency of a single circle, if $[AB] \parallel p$. 13. ● Lay off the segments $|AB| = |BC| = p/2$ (p being the given perimeter) on the sides of the angle ABC (see the figure), inscribe into the given angle a circle touching the sides of the angle at points A and C and draw a tangent to that circle from the given point K . The triangle A_1BC_1 is the required triangle (prove this using the property of segments of tangents drawn to a circle from the same point).

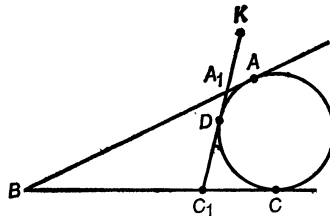

7.3. Problems on Calculation

1. (a) $\hat{B} = \arccos(5/13) = \arcsin(12/13)$. ● Use the cosine theorem;
- (b) 84 sq cm. ● Apply Heron's formula: $S = \sqrt{p(p-a)(p-b)(p-c)}$, where $p = 0.5(a+b+c)$; (c) $|BD| = h_b = 11.2$ cm;
- (d) 4 cm. ● See problem 12 in 7.1; (e) 65/8 cm. ● See problem 13 in 7.1;
- (f) $28\sqrt{13}/9$ cm. ▲ $S_{ABC} = S_{ABE} + S_{CBE} = S$; $S = \frac{1}{2}ac \sin \hat{B} = \frac{1}{2}cb \sin \frac{\hat{B}}{2} + \frac{1}{2}ab \sin \frac{\hat{B}}{2} \Rightarrow lb = \frac{2ac}{a+c} \cos \frac{\hat{B}}{2}$, $(\cos \hat{B} + 1 =$

$= 2 \cos^2 \frac{\hat{B}}{2}$); (g) $\frac{\sqrt{505}}{2}$ cm. \blacktriangle We introduce a rectangular system of coordinates such that the origin coincides with the vertex A (see the figure), and the abscissa axis is chosen so that the side AC should belong to that axis. In that system of coordinates the vertices

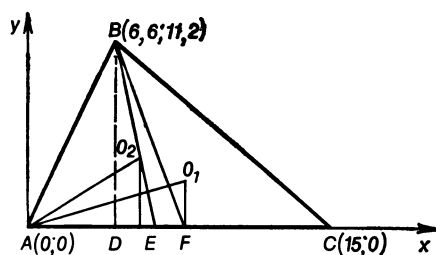

A and C have the coordinates $A(0, 0)$, $C(15, 0)$. Let us find the coordinates of the point B . Its ordinate y_B is numerically equal to the altitude $h_b = 11.2$ cm, and the abscissa can be found from the relation $h_b^2 + |AD|^2 = c^2$, $|AD| = x_B = 6.6$, $F(7.5; 0)$. Now we have

$$|BF| = m_b = \sqrt{(x_F - x_B)^2 + (y_F - y_B)^2} = \sqrt{505}/2;$$

(h) $\sqrt{65}/8$ cm. \blacktriangle The required distance d can be found from the formula $d = \sqrt{(x_{O_1} - x_{O_2})^2 + (y_{O_1} - y_{O_2})^2}$, where x_{O_1} and y_{O_1} are the coordinates of the centre of the circumscribed circle and x_{O_2} and y_{O_2} are the coordinates of the centre of the inscribed circle. Let us determine the coordinates] $x_{O_1} = b/2 = 7.5$, $y_{O_2} = r = 4$; $y_{O_1} = \sqrt{R^2 - (b/2)^2} = 25/8$, $x_{O_2} = r \cot(\hat{A}/2) = 7$ ($\cos \hat{A} = 33/65$). It is

now easy to find d . (i) $\sqrt{265}/24$. \blacktriangle Since the coordinates of the centre of the circumscribed circle are known: $O_1(7.5; 25/8)$, it follows that in order to find $|GO_1|$ it is necessary to determine the coordinates of the point G . Let us find them. The vectors \vec{BF} and \vec{BG} are collinear, i.e. $\vec{BG} = \lambda \vec{BF}$, with $\lambda = 2/3$. We have: $\vec{BF} = (0.9; -11.2)$ and $\vec{BG} = (0.6; -22.4/3)$. Suppose x_G and y_G are the abscissa and the ordinate of the point G respectively. Then $x_G - x_B = x_G - 6.6 = 0.6$ and $y_G - y_B = y_G - 11.2 = -22.4/3$, whence it follows that $x_G = 7.2$ and $y_G = 11.2/3 = 56/15$. From the formula

$\sqrt{(x_G - x_{O_1})^2 + (y_G - y_{O_1})^2}$ we find the distance $|GO_1|$. 2. $a^2 \times (\sqrt{3} - 1)/4$. 3. 4 cm. 4. 5.2 m. 5. $\pi/4$ or $3\pi/4$. 6. $a\sqrt{3}(2 - \sqrt{3})/2$. 7. 10 cm, 10 cm, 12 cm. 8. 1. 9. 1 dm. 10. $\arccos(2/3)$, $\arccos(2/3)$, $\pi - 2 \arccos(2/3)$. 11. 13 cm, 15 cm. 12. 3; 4; 5. 13. 6. 14. Rr . \blacktriangle Suppose a , b are the lengths of the legs, c is the length of the hypotenuse. Then $p = (a + b + c)/2$ and it is easy to notice that $a + b + c = 2R$. Consequently,] $p = R$, and since $S = pr$, it follows that $S = Rr$. 15. 27 dm, 64 dm. 16. $\sqrt{7}$. 17. 10 cm, 10 cm, 1 cm. 18. $(\sqrt{3} + \sqrt{15})/4$

sq cm. 19. $3S/4$. \blacktriangle Suppose O is the intersection point of the medians $[AN]$, $[BF]$, $[CM]$ of the triangle ABC . On the ray $[BF]$ beyond the point F , we lay off a point P so that $|PF| = |OF|$, and connect the points A and P by a line segment. The lengths of the sides of the triangle AOP are respectively equal to $2|AN|/3$, $2|CM|/3$, $2|BF|/3$. Therefore, the required area is given by the relation

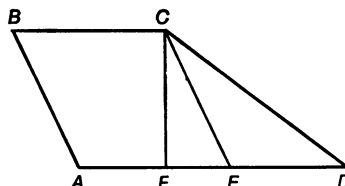

$S/3: (2/3)^2$. 20. $bc\sqrt{2}/(b+c)$. 21. $3\sqrt{7}/2$ cm, 1.5 cm, 3.5 cm. 22. $\pi/6, \pi/3, \pi/2$. 23. $\sqrt{b(b+c)}$. 24. $a^2b^2/(2a^2 - b^2)$. 25. $\pi/2 + \arccos \sqrt{5}/8$. 26. 7 cm, 15 cm. 27. 6 cm, 9 cm, $3\sqrt{34}/2$ cm. 28. $(1/2)(a-b)^2 \sin \alpha$.

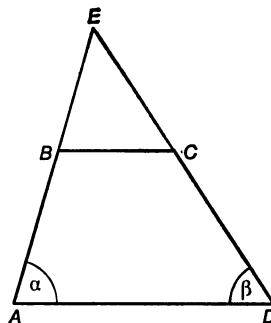

29. $\sqrt{2 + \sqrt{3}}$. 30. 216 sq cm. 31. 2 cm. 32. 15 cm. \bullet Draw $(CE) \parallel (AB)$ in the trapezoid $ABCD$ (see the figure) and find the length of the altitude CF of the triangle ECD .

33. $\frac{1}{2}(a^2 - b^2) \frac{\sin \alpha \sin \beta}{\sin(\alpha + \beta)}$.

\bullet Extend the nonparallel sides of the trapezoid $ABCD$ till they intersect at the point E (see the figure) and find the area of the trapezoid as the difference between the areas of the triangles AED and BEC .

34. 2 cm, 5 cm, 5 cm, 8 cm.

35. $(9\sqrt{3}/4)r^2$. \bullet Prove that the quadrangle $ABEK$ is a trapezoid.

36. $\frac{18\sqrt{5}}{5}$ cm. 37. $85/8$ cm. \blacktriangle From

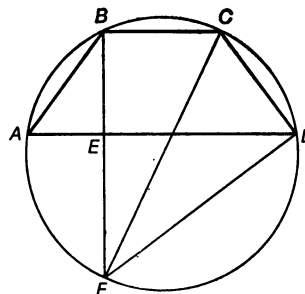

the vertex B we draw a perpendicular to the base AD till it meets the circle at the point F (see the figure). The segment $[CF]$ is a diameter of the circle circumscribed about the trapezoid $ABCD$

(the angle $\widehat{FBC} = \pi/2$ is an inscribed angle). It follows from the similarity of the triangles AEB and FED , that

$$\begin{aligned} \frac{|BE|}{|ED|} &= \frac{|AE|}{|EF|} \quad \text{or} \quad |EF| = |AE| \frac{|ED|}{|BE|} \\ &= \frac{21-9}{2} \cdot \frac{1}{8} \left(21 - \frac{21-9}{2} \right) = \frac{45}{4}. \end{aligned}$$

Then, from the right triangle FBC we find $|FC|$ and R :

$$|FC| = \sqrt{|BF|^2 + |BC|^2} = \sqrt{\left(8 + \frac{45}{4}\right)^2 + 9^2}$$

$$= \frac{85}{4} \quad \text{and} \quad R = \frac{|CF|}{2} = \frac{85}{8} \text{ cm.}$$

38. $5\pi/12, 7\pi/12$. ● Prove that the trapezoid $ABCD$ is isosceles and that the length of its midline is $|AD|/\sqrt{3}/2$. 39. $\sqrt{(a^2 + b^2)/2}$. ▲ Suppose $|BC| = b$, $|AD| = a$, $|EF| = x$, and the altitudes of the trapezoids $EBCF$ and $Aefd$ are h_1 and h_2 respectively (see the figure). By the hypothesis, $S_{EBCF} = S_{ABCD}/2$ and $S_{Aefd} = S_{ABCD}/2$ or $h_1(x + b)/2 = (a + b)(h_1 + h_2)/4$ and $h_2(x + a)/2 = (a + b) \times (h_1 + h_2)/4$. Let us transform these equations:

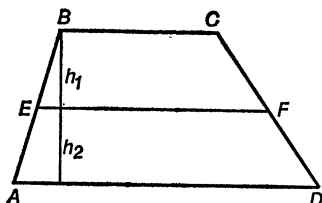

$$\frac{2h_1}{h_1 + h_2} = \frac{a + b}{x + b}, \quad (1)$$

$$\frac{2h_2}{h_1 + h_2} = \frac{a + b}{x + a}. \quad (2)$$

Adding together equations (1) and (2) we get $2 = (a + b) \left(\frac{1}{x + a} + \frac{1}{x + b} \right)$, solving which we get the answer. 40. $((a + b)/a)^2$.

▲ We draw $[CE] \parallel [BD]$ (see the figure). The areas of the triangles ABC and CDE are equal since $|BC| = |DE| = b$, and their alti-

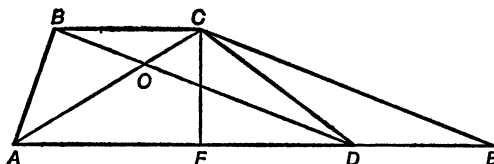

tudes are equal to the altitude of the trapezoid $[CF]$. Consequently, the trapezoid $ABCD$ is equivalent to the triangle ACE . The triangles ACE and AOD are similar and, therefore,

$$\frac{S_{ACE}}{S_{AOD}} = \frac{S_{ABCD}}{S_{AOD}} = \frac{|AE|^2}{|AD|^2} = \frac{(a + b)^2}{a^2}.$$

41. $3r$. 42. $R^2 \arcsin \frac{r}{R - r}$. ● Find the angle of the sector α and then calculate the area S of the sector by the formula $S = R^2\alpha/2$. 43. $5R^2(2\sqrt{3} + 5\pi)/6$. 44. $1/3$. 45. $(Rr/(R + 2r)^2)[3R - 2r \pm \sqrt{8(R^2 - 2Rr)}]$. 46. $\sqrt{2 - \sqrt{3}}/\sqrt{3}$. ▲ Since BD is the bisector of the angle ABC , it follows that $[PQ]$ is the diameter of the inscribed

circle and the triangles PQM and PQN are right triangles (see the figure)

($\widehat{PNQ} = \widehat{PMQ} = \pi/2$). Suppose the arc PN is of x rad, NM is of y rad. Then

$\widehat{DBC} = (y - x)/2 = \pi/6$, and $y + x = \pi$; hence we find that $x = \pi/3$, $y = 2\pi/3$

and $\widehat{PQN} = \pi/6$ and $\widehat{QPN} = \pi/3$. Let

us find the angles \widehat{MQP} and \widehat{MPQ} ,

$\widehat{ACB} = \pi - (\pi/3 + \pi/4) = 5\pi/12$, and

suppose the arc MN is of z rad and the arc MQP is of t rad. Then $(t - z)/2 = 5\pi/12$, $t + z = 2\pi$. From these equations we

find $z = 7\pi/12$ and then the difference $y - z = \frac{2\pi}{3} - \frac{7}{12}\pi = \frac{\pi}{12}$.

Thus, $\widehat{QPM} = \frac{\pi}{24}$. Setting $|PQ| = 1$, we find S_{PQM} and S_{PQN} :

$$S_{PQM} = \frac{1}{2} \cdot 1 \sin \frac{\pi}{24} \cos \frac{\pi}{24} = \frac{1}{4} \sin \frac{\pi}{12};$$

$$S_{PQN} = \frac{1}{2} \sin \frac{\pi}{6} \cos \frac{\pi}{6} = \frac{1}{4} \sin \frac{\pi}{3}$$

and obtain the required relation:

$$x_1 = \frac{\sin \frac{\pi}{12}}{\sin \frac{\pi}{3}} = \frac{\sqrt{2 - \sqrt{3}}}{\sqrt{3}}$$

$$\left(\text{here } \sin \frac{\pi}{12} = \sqrt{\frac{1 - \cos \frac{\pi}{6}}{2}} = \frac{\sqrt{2 - \sqrt{3}}}{2} \right).$$

47. $\sqrt{7/2}$. \blacktriangle We introduce the rectangular system of coordinates Oxy so that the origin coincides with the centre of the larger circle and the abscissa axis contains the line segment connecting the centres of the circles $[OO_1]$ (see the figure).

To find $|AC|$, we determine the coordinates of the points A and C . The equations of the circles with centres at the points O and O_1 have the forms

$$x^2 + y^2 = (\sqrt{2})^2 \quad (1)$$

and

$$(x - 2)^2 + y^2 = 1. \quad (2)$$

The system of equations (1) and (2) has two solutions, one of which

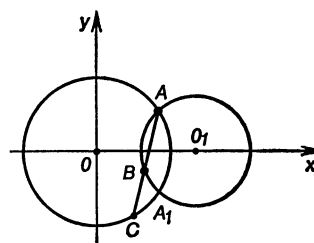
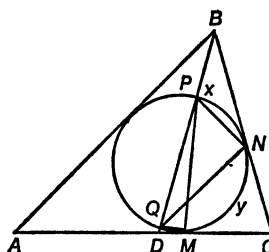

$(x = 5/4, y = \sqrt{7}/4)$ defines the coordinates of the point A . Suppose x_C and y_C are the coordinates of the point C . Then $x_B = (x_A + x_C)/2$, $y_B = (y_A + y_C)/2$. We have a system of equations

$$x_C^2 + y_C^2 = 2, \quad \left(\frac{x_C + 5/4}{2} - 2\right)^2 + \left(\frac{y_C + \sqrt{7}/4}{2}\right)^2 = 1,$$

solving which, we find: $x_C = 13/16$, $y_C = -7\sqrt{7}/16$. Now we have

$$|AC| = \sqrt{(x_A - x_C)^2 + (y_A - y_C)^2} \\ = \sqrt{\left(\frac{5}{4} - \frac{13}{16}\right)^2 + \left(\frac{\sqrt{7}}{4} + \frac{7\sqrt{7}}{16}\right)^2} = \sqrt{\frac{7}{2}}.$$

48. $\frac{9}{2}$ sq cm. \blacktriangle Suppose x is the length of one of the diagonals; then the length of the other is $6 - x$. The area of the convex quadrangle, whose diagonals are mutually perpendicular, is half the product of the lengths of these diagonals: $S(x) = x(6 - x)/2$, $x \in [0, 6]$. Thus, the largest possible value of the area of the quadrangle coincides with the greatest value of the function $S(x)$ on the interval $[0; 6]$. Since $S'(x) = 0$ for $x = 3$ (a point of maximum) and $S(0) = S(6) = 0$, the function $S(x)$ attains its largest value at the point $x = 3$:

$\max_{x \in [0; 6]} S(x) = S(3) = 9/2$ sq cm. 49. $2(\sqrt{2} - 1)$. \bullet Half the sum

of the lengths of the bases of the trapezoid is equal to $(4 - (1 + \sqrt{2})x)/2$, where x is the length of the altitude. 50. $(a \sin \alpha)/3$. 51. The area of the parallelogram is the largest if one of its sides coincides with the midline of the triangle.

Chapter 8

SOLID GEOMETRY

8.1. A Straight Line, a Plane, Polyhedra, Solids of Revolution

1. $12\sqrt{2}/5$ or $\sqrt{337}/5$ cm. 2. $\arcsin(\sin \varphi \sin \psi)$. \blacktriangle Let us denote the planes of the faces of the dihedral angle at the edge (NM) by α and β (see the figure). We have: $A \in (NM)$,

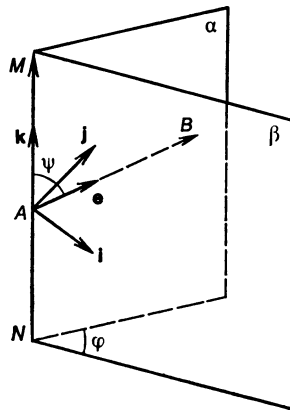

$[AB] \in \alpha$, $\widehat{(NM, AB)} = \psi$, $\widehat{(\alpha, \beta)} = \varphi$. We introduce a rectangular basis (i, j, k) at the point A so that $i \perp (NM)$, $j \perp (NM)$, $k \uparrow (NM)$ and $j \perp \beta$.

Suppose e is a unit vector of the same direction as the vector \vec{AB} . Let us express the unit vector e in terms of the components (i, j, k) , $e = \cos \varphi \sin \psi i + \sin \varphi \sin \psi j + \cos \psi k$. Next we have

$$\sin \widehat{(e, \beta)} = \sin \left(\frac{\pi}{2} - \widehat{(e, j)} \right)$$

$$= \cos \widehat{(e, j)} = \mathbf{e} \cdot \mathbf{j} = \sin \varphi \sin \psi.$$

3. $\arccos(\cot \varphi \cot \psi)$. The problem is solvable if $\cot \varphi \cot \psi \leq 1$.

4. $2l(3 + \tan^2 \varphi)$, 0. ● Consider two cases: (1) the points A and B lie on the same side of the plane γ ; (2) the points lie on different sides of the plane γ . 5. $(m + 2h)/3$; $(2h - m)/3$; $m/3$. 6. $2l \sin \alpha \times$

$\times \sqrt{2S + l^2 \cos^2 \alpha}$. 7. $\sqrt[3]{2V \tan^2 \beta / \sin \alpha}$. 8. $b^3 / \sqrt{2}$. 9. $\arccos(5/3\sqrt{6})$.

▲ Suppose $|\vec{AA}_1| = 2$, then from the right triangles NPC and MPD (see the figure) we find that $|\vec{NC}| = \sqrt{6}$ and $|\vec{MD}| = 3$. Let us consider the vector equality $\vec{NC} = \vec{NM} + \vec{MD} + \vec{DC}$ or $\vec{NC} - \vec{MD} = \vec{NM} + \vec{DC}$. Squaring this equality, we get

$$|\vec{NC}|^2 + |\vec{MD}|^2 - 2\vec{NC} \cdot \vec{MD} = |\vec{NM}|^2 + |\vec{DC}|^2 + 2\vec{NM} \cdot \vec{DC}$$

or $6 + 9 - 2\sqrt{6} \cdot 3 \cos \varphi = 1 + 4 + 0$ ($\vec{NM} \perp \vec{DC}$), where $\varphi =$

$= \widehat{(\vec{NC}, \vec{MD})}$. Solving the equation $\cos \varphi = \frac{5}{3\sqrt{6}}$, we get the answer.

10. $\arccos(1/3)$. ▲ We introduce a rectangular basis $\mathbf{i}, \mathbf{j}, \mathbf{k}$ with the origin at the vertex B of the cube (see the figure). The required angle between the planes (BCB_1) and (BC_1M) is equal to the angle between the straight lines perpendicular to those planes. Let us find the vectors normal to these planes. It is evident that the vector $\mathbf{n}_1 \perp (BCB_1)$ has the coordinates $(1; 0; 0)$. Assume that $\mathbf{n}_2 = (a; b; c)$ is a vector normal to the plane (BC_1M) . Then $\mathbf{n}_2 \cdot \vec{BC}_1 = 0$ and $\mathbf{n}_2 \cdot \vec{BM} = 0$. The vectors \vec{BC}_1 and \vec{BM} have the coordinates $(0; 1; 1)$ and $(1; 1/2; 0)$ respectively. We have equations

$$\begin{cases} b + c = 0, \\ a + \frac{b}{2} = 0. \end{cases}$$

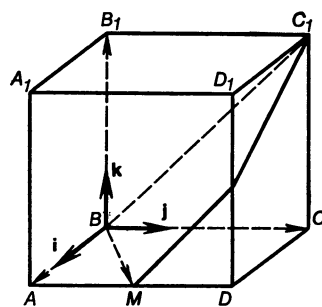
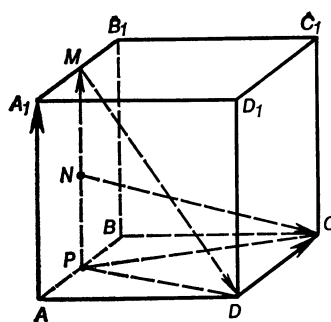

Setting $c = 2$, we get $b = -2$ and $a = 1$; thus, $\mathbf{n}_2 = (1; -2; 2)$. Next we determine the angle between the vectors \mathbf{n}_1 and \mathbf{n}_2 :

$$\mathbf{n}_1 \cdot \mathbf{n}_2 = |\mathbf{n}_1| \cdot |\mathbf{n}_2| \cos(\widehat{\mathbf{n}_1, \mathbf{n}_2}),$$

$$\cos(\widehat{\mathbf{n}_1, \mathbf{n}_2}) = \frac{\mathbf{n}_1 \mathbf{n}_2}{|\mathbf{n}_1| |\mathbf{n}_2|} = \frac{1 \cdot 1 + 0(-2) + 0 \cdot 2}{1 \cdot 3} = \frac{1}{3}.$$

Since $1/3 > 0$, the angle between the vectors is equal to the angle between the straight lines parallel to these vectors and, consequently, to the required angle between the planes (BCB_1) and (BC_1M) . *Remark.* We can take the vector $(c/2; -c; c)$, ($c \neq 0$), as \mathbf{n}_2 . 11. $a\sqrt{29}/3$. 12. $l^3 \sin^2 \beta \sqrt{3 \cos^2 \beta - \sin^2 \beta}/3$.

$$13. \frac{p^3 \sin \alpha}{16(1 + \sin(\alpha/2))^3} \cdot \frac{\sqrt{\sin \frac{\alpha - \beta}{2} \sin \frac{\alpha + \beta}{2}}}{\sin(\beta/2)}.$$

14. $\sqrt{(S \cos \alpha)^3 \tan \alpha} / \sqrt{27}$. 15. $\arccos(\sqrt{3}/4)$. ● Determine the angle between the straight lines AC and PQ , using the equality $\vec{PQ} \cdot \vec{CA} = |\vec{PQ}| |\vec{CA}| \cos \varphi$, where $\vec{PQ} = \vec{QC} + (\vec{CA} + \vec{CB})/3$ and φ is the required angle. 16. $a^3 \sqrt{3}/8$. ● Prove that $(MN) \perp (PQ)$. 17.

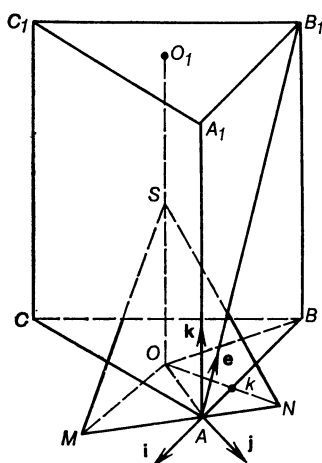

17. $3\sqrt{2} + \sqrt{3}$. ▲ All angular dimensions are known in a regular tetrahedron, in particular, α is the magnitude of the dihedral angle formed by a lateral face and the plane of the base; $\sin \alpha = 2\sqrt{2}/3$; $\cos \alpha = 1/3$. Suppose $ABCA_1B_1C_1$ is a regular triangular prism (see the figure). We have: $|AB| = 3$, $|AA_1| = 4\sqrt{3}$, MSN is a lateral face of the regular tetrahedron, $[AB_1] \in (MSN)$, O and O_1 are the centres of the triangles ABC and $A_1B_1C_1$ respectively. We introduce

the designation $\widehat{NOB} = \varphi$ and a rectangular basis (i, j, k) at the point A such that $i \uparrow [BA]$, $k \uparrow [AA_1]$; $j \perp (ABB_1)$. Let us designate the unit vectors as \mathbf{e} and \mathbf{n} : $\mathbf{e} \uparrow [AB_1]$ and $\mathbf{n} \perp (MSN)$.

The unit vectors \mathbf{e} and \mathbf{n} can be represented in the basis (i, j, k) as follows:

$$\mathbf{e} = -\sqrt{\frac{3}{19}} \mathbf{i} + \frac{4}{\sqrt{19}} \mathbf{k}, \quad \mathbf{n} = (\mathbf{i} \sin \varphi + \mathbf{j} \cos \varphi) \sin \alpha + \mathbf{k} \cos \alpha.$$

From the hypothesis $[AB_1] \in (\widehat{MSN}) \Rightarrow \mathbf{n} \cdot \mathbf{e} = 4/(3\sqrt{19}) - \sqrt{3/19} \times (2\sqrt{2}/3) \sin \varphi = 0$. By the last formula we find: $\sin \varphi = \sqrt{2/3}$; $\cos \varphi = 1/\sqrt{3}$. From the triangles OBK and AKN we find the length of the segment $[ON]$, and from the triangle OSN we find the length of the edge $|SN|$ of the tetrahedron. 18. $a/\sqrt{2}$; $a/(2\sqrt{6})$.

19. $a/\sqrt{2}$. 20. $2k^3 \sqrt{3}/(27 \sin^2 \alpha \cos \alpha)$.

21. $(\sqrt{3} l^3 \tan^2 \alpha) / \sqrt{(4 \tan^2 \alpha + 1)^3}$. 22. $(\sqrt{3}/4) b^3 (4 \tan^2 \alpha + 1)^{3/2} \cot^2 \alpha$. 23. $\sqrt[3]{3} \sqrt[3]{V^2 \cot^2 \alpha} \left(\cos^2 \frac{\alpha}{2} / \cos \alpha \right)$. 24. $(a^3 \tan \alpha)/24$,

$(a^3 \tan \alpha)/8$, $\alpha \in (0, \pi/2)$. ● Consider two cases: (1) the orthogonal projection of the vertex onto the plane of the base of the pyramid coincides with the centre of the circle inscribed into the regular triangle, and (2) the orthogonal projection of the vertex onto the plane of the base of the pyramid coincides with the centre of the circle touching one of the sides of the regular triangle and the extensions of its other

two sides. 25. $\frac{a(a^2-b^2)}{24} \tan \alpha$, $\frac{a(a^2-b^2)}{8} \tan \alpha$, $\alpha \in (0; \pi/2)$. ● $V_{AB_1C_1C_1B} =$

$= V_{ABCA_1B_1C_1} - V_{AA_1B_1C_1}$. Calculate the volume $V_{ABCA_1B_1C_1}$ of the given truncated pyramid as the difference of the volumes of the pyramids $SABC$ and $SA_1B_1C_1$ and use the instruction given in the answer to the preceding problem. 26. $(\sqrt{3}/4) (1 + 2 \tan \varphi) a^2$;

$(\sqrt{3}/4) (\tan \varphi + \sec \varphi + 1) a^2$; $\varphi \in (0; \pi/2)$. 27. $1/7$. 28. $\arccos 7/15$.

● Prove that the length of a lateral edge of the pyramid is double the length of the side of the base. 29. (b) $\arccos \frac{1-3 \cos^3 \varphi}{2}$. ▲ We denote

the magnitude of the plane angle adjacent to the base of a lateral face by α and the magnitude of the required angle by ψ . By the cosine law, for a trihedral angle formed by the adjacent lateral faces and the base, we find two equalities

$$\begin{cases} \cos \alpha = \cos \alpha \cos \frac{\pi}{3} + \sin \alpha \sin \frac{\pi}{3} \cos \varphi, \\ \cos \frac{\pi}{3} = \cos^2 \alpha + \sin^2 \alpha \cos \psi, \end{cases}$$

from which it follows that $\cos \psi = \frac{1}{2} - \frac{3}{2} \cos^2 \varphi$. 30. $(\sqrt{3}/4) h^3 \times (3 \tan^2 \varphi - 1)$, $\varphi \in (\pi/6; \pi/2)$. 31. $25/2$. ▲ Suppose $(AO) \perp (BSC)$,

$\widehat{ASO} = \varphi$, $\widehat{BSC} = \alpha$ (see the figure). Then $V_{SABC} = \frac{1}{3} \cdot \frac{1}{2} |CS| \times$

$\times |BS| \sin \alpha |AS| \sin \varphi$, $V_{SA_1B_1C_1} = \frac{1}{3} \cdot \frac{1}{2} |C_1S| |B_1S| \sin \alpha \times |A_1S| \sin \varphi$. Hence we have

$$V_{SA_1B_1C_1} : V_{SABC} = (|A_1S| |B_1S| |C_1S|) : (|AS| |BS| |CS|).$$

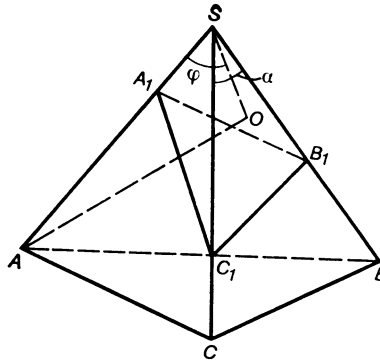

Substituting the numerical values, we obtain

$$\frac{V_{SABC} - V_{SA_1B_1C_1}}{V_{SA_1B_1C_1}} = \frac{(1+2)(1+2)(2+1) - 1 \cdot 1 \cdot 2}{1 \cdot 1 \cdot 2} = \frac{25}{2}.$$

32. $\pi/2$. ● Use the solution of problem 31.

33. $2a^2 \cos \alpha \sqrt{1 + \sin^2 \alpha}$; $(a^3/3) \sin 2\alpha \cos \alpha$. 34. 1.

35. $\frac{\sqrt{2}}{6} a^3 \frac{\cos(\alpha/2)}{\sqrt{-\cos \alpha}}$, $\alpha \in (\pi/2; \pi)$.

36. $\left(4l^3 \sin^2 \frac{\beta}{2} \cos \frac{\beta}{2}\right) / (3(1 + \sin^2 \beta)^{3/2})$, $\beta \in (0; \pi)$.

37. $\frac{\sqrt{\sqrt{5}+1}}{6} a^3$. 38. $6 \left(\sqrt[3]{\frac{ak^2 \sin \alpha \sin \gamma}{6 \sin(\alpha + \gamma)}}\right)^2$,

$6 \left(\sqrt[3]{\frac{ak^2 \sin \alpha \sin \gamma}{6 \sin |\alpha - \gamma|}}\right)^2$, $\alpha \neq \gamma$. 39. 26 sq m.

40. $\arctan \frac{m^2 - 1}{2m}$. 41. $\arctan (\sqrt{\cot^2 \alpha + \cot^2 \beta})$.

42. $\arccos (\sqrt{-\cos \alpha})$, $\alpha \in (\pi/2; \pi)$. Use the cosine law for a trihedral angle. 43. $\arctan \sqrt{3/2}$. 44. $(a^3/8\pi) \sin 2\alpha \cos \alpha$.

45. $\frac{\pi b^3}{8} \frac{\cot \frac{\beta}{2} \tan \alpha}{\sin^2 \frac{\beta}{2}}$.

46. $\frac{S \sin \frac{\alpha}{2}}{3 \left(1 + \sin \frac{\alpha}{2}\right)} \sqrt{\frac{S \left(1 - \sin \frac{\alpha}{2}\right)}{\pi \sin \frac{\alpha}{2}}}$.

$$47. \frac{\pi \sqrt{6}}{27} a^3. \quad 48. \frac{2\pi - 3 \sqrt{3}}{10\pi + 3 \sqrt{3}}.$$

$$49. \frac{\pi \alpha^2 \tan \frac{\alpha}{2} \left(1 + \sin \frac{\alpha}{2}\right)}{\cos \frac{\alpha}{2} \cos^2 \beta}. \quad 50. \frac{7}{17}.$$

8.2. Problems on Combinations of Polyhedra and Solids of Revolution

1. $\frac{4V}{\sqrt{3} (4W \cot \alpha)^{2/3}}$. 2. $(a^3 (2 + \tan \alpha)^3 \cot^2 \alpha) / 6$.
3. For $\alpha \in \left(0; \frac{\pi}{2}\right]$, $\beta \in \left(0; \frac{\pi}{2}\right]$, $\alpha \neq \beta$ there are two solutions: $\frac{V}{\sin(\alpha + \beta)}$ and $\frac{V}{\sin|\alpha - \beta|}$; for $\alpha \in \left(0; \frac{\pi}{2}\right]$, $\beta \in \left(0; \frac{\pi}{2}\right]$, $\alpha = \beta$ there is one solution: $\frac{V}{\sin(\alpha + \beta)}$; here $V = \frac{4a^3}{75} \sin^2 \varphi \times$
 $\times \cos \varphi \sin \alpha \sin \beta$. 4. $\frac{32r^3 \sqrt{\cos \alpha}}{3 \sin \frac{\alpha}{2}}$. 5. $\frac{\pi l^2 \cos \alpha}{1 + 3 \cos^2 \alpha}$. 6. $\frac{\pi l^3 \sin^2 \frac{\alpha}{2}}{9} \times$
 $\times \sqrt{\frac{1 + 2 \cos \alpha}{3}}$. 7. $\frac{\pi r^2}{\sin^4(\alpha/2)}$. 8. $\frac{\pi a^3}{24} \sin^3 \alpha \tan \varphi$. 9. $2 \arcsin(\tan \alpha)$,
 $\alpha \in (0; \pi/4)$. 10. $\frac{ab (\sqrt{4a^2b^2 + c^2(a^2 + b^2)} \pm 2ab)}{c(a^2 + b^2)}$. 11. $\frac{3h}{4 \cos \alpha + 2}$,
 $\alpha \in \left(0; \frac{2}{3} \pi\right)$.

▲ Since the pyramid $SABC$ (see the figure) is regular, the centre of the sphere circumscribed about it is on the straight line (SO) ($|SO| = h$), lying in the plane (ASS_1) , where S_1 is the point of intersection of the line (SO) and the sphere. Connecting the point A with S_1 by a line segment, we get a right triangle $\triangle SAS_1$ ($\hat{A} = \frac{\pi}{2}$ as an inscribed angle resting on the diameter SS_1). Suppose $|SS_1| = 2R$, $|BC| = x$; then $|AO| = x/\sqrt{3}$, and from the proportion $\frac{|OS_1|}{|AO|} = \frac{|AO|}{|OS|}$ we have $x^2/3 = h(2R - h)$. Since the triangle AOS is right-

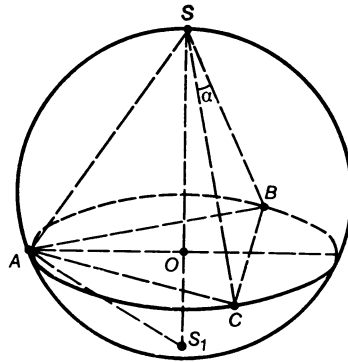

angled, we have $|AS|^2 = x^2/3 + h^2$. We can now find $|AS|$
 $|AS|^2 + |SC|^2 - 2|AS||SC|\cos\alpha = x^2$ ($|AS| = |SC|$),

$$|AS|^2 = x^2/(2(1-\cos\alpha)) \quad \text{or} \quad \frac{x^2}{2(1-\cos\alpha)} = \frac{x^2}{3} + h^2,$$

whence we have $\frac{x^2}{3} = \frac{2h^2(1-\cos\alpha)}{1+2\cos\alpha}$. Solving now the equation

$$\frac{2h^2(1-\cos\alpha)}{1+2\cos\alpha} = h(2R-h), \quad \text{we get the answer. 12. } \frac{\sqrt{h^2\cos^2\alpha + a^2}}{2\cos\alpha}.$$

● The centre of the circumscribed sphere lies at the point of intersection of the plane, perpendicular to the altitude of the pyramid and passing through its midpoint, and the straight line perpendicular to the plane of the base of the pyramid and passing through the midpoint of the hypotenuse of the triangle lying at the base of the pyramid.

13. $\frac{4\pi a^3}{9\sqrt{3}\sin^3 2\alpha}$. 14. $\frac{4}{3}R^3 \sin^2 2\varphi \sin^2 \varphi \sin \alpha$, $\varphi \in (0; \pi/4)$.

15. $\sqrt[3]{\frac{6V}{\pi} \cdot \frac{\sin^2 \alpha}{1+\cos^2 \alpha}}$, $\alpha \in (\pi/4; \pi/2)$. 16. $\{\arcsin(2/\sqrt{5}); \pi/4\}$.

17. $\left\{ \arccos \frac{309}{325}; \arccos \frac{3}{13} \right\}$. ▲ Since the lateral edges of the

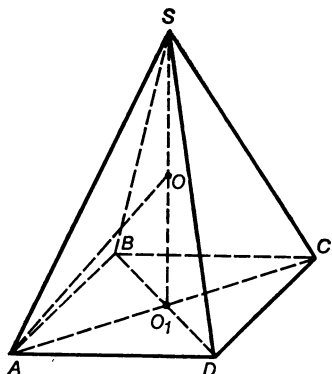

pyramid $SABCD$ make equal angles with the plane of the base (see the figure), the orthogonal projection O_1 of the vertex S of the pyramid onto the plane of the base ($ABCD$) is the centre of the circle circumscribed about the rectangle $ABCD$. The section of the circumscribed sphere formed by the plane of the base ($ABCD$) of the pyramid is a circle circumscribed about the rectangle $ABCD$. Consequently, the centre O of the circumscribed sphere belongs to the straight line (SO_1). The triangle ASC is equilateral since

$\widehat{SAC} = \widehat{SCA}$. The side $[AC]$ of the base of this triangle is also the diagonal of the rectangle $ABCD$ and

therefore, $|AC| = \sqrt{|AB|^2 + |BC|^2} = 5$. Since the centre of the sphere circumscribed about the pyramid belongs to the plane (ASC), the radius R of the circle circumscribed about the triangle ASC is equal to 6.5. From the right triangle AOO_1 we have

$$||SO_1| - R|^2 = R^2 - \frac{|AC|^2}{4},$$

$$|SO_1| = R \pm \sqrt{R^2 - \frac{|AC|^2}{4}} = 6.5 \pm 6.$$

If the centre O of the circumscribed sphere belongs to the pyramid $SABCD$, the radical must be preceded by the plus sign. The length of the lateral edge can be found from the right triangle ASO_1 : $|AS| = \sqrt{|SO_1|^2 + |OC_1|^2} = \sqrt{162.5}$. By the cosine law we find, from the triangle BSC , that

$$\cos(\widehat{BSC}) = \frac{|BS|^2 + |CS|^2 - |BC|^2}{2|BS||CS|} = \frac{309}{325}, \quad \widehat{BSC} = \arccos \frac{309}{325}.$$

If the centre O of the sphere does not belong to the pyramid $SABCD$, the radical must be preceded by the minus sign, and then $\widehat{BSC} = \pi - \arccos\left(-\frac{3}{13}\right) = \arccos \frac{3}{13}$. 18. $\frac{b \sin \alpha}{2\left(1 + \cos \frac{\alpha}{2}\right)}$.

▲ Suppose the point O is the centre of a ball inscribed into the pyramid $SABC$ (see the figure), in which $|AC| = |AB| = b$, $(SA) \perp (ABC)$, (ALS) is the bisector plane of the dihedral angle formed by the non-parallel faces ASC and ASB . By

the hypothesis, $\widehat{BAC} = \widehat{ALS} = \alpha$. The point $O \in (ALS)$ and (OL) is the bisector of the angle ALS . The projection of the point O onto the plane of the base, which will be designated as O_1 , belongs to the bisector (AL) of the angle CAB , and the projection of the inscribed ball onto the plane of the base is the large circle of the ball with centre at O_1 , touching the sides AB and AC of the triangle ABC . Let us denote the point of tangency of that circle and the side AC by K , and then $|O_1K| = |OO_1| = r$, where r is the radius of the inscribed ball.

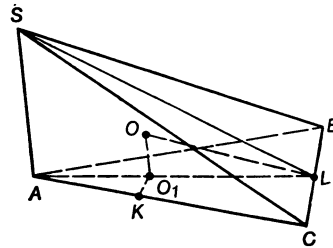

From the right triangle OO_1L we find $|O_1L| = r \cot(\alpha/2)$. Furthermore, we have $|AO_1| = |AL| - |O_1L| = b \cos(\alpha/2) - r \cot(\alpha/2)$. From the right triangle AO_1K we get a relation

$$\begin{aligned} |O_1K| = r &= |AO_1| \sin(\alpha/2) \\ &= (b \cos(\alpha/2) - r \cot(\alpha/2)) \sin(\alpha/2), \end{aligned}$$

solving which for r we get the answer. 19. $hr/(\sqrt{r^2 + 4h^2} \pm r)$. ● Consider two cases of location of the centre of the sphere with respect to the plane of the base of the pyramid. 20. $\{1/2\sqrt{6}; 1/\sqrt{6}\}$. ● When solving the problem, bear in mind that there are five spheres touching all the planes of the faces of any triangular pyramid: the sphere inscribed into the pyramid and four spheres each of which touches one of the faces of the pyramid and the extensions of its three other faces. 21.

$\frac{\pi a^3}{6} \sin^3 \alpha \tan^3 \frac{\alpha}{2}$. ● Find the volume V of the pyramid, the area S of the full surface of the pyramid, and from the equation $V = (1/3) rS$

determine the radius r of the inscribed ball. 22. $\frac{\pi a^2 \cos \alpha}{1 + \sin \alpha}$, $\alpha \in (0; \pi/2)$.

● To find the radius r of the sphere, use the formula $r = \frac{a}{2} \tan \frac{\varphi}{2}$, where φ is the magnitude of the angle between the plane of one of the nonparallel faces and the plane of the base of the pyramid.

23. $\frac{S \cot^2(\beta/2)}{\pi \cos \beta}$. 24. $\left\{ \frac{4R^3}{3} \frac{(1 + \tan(\beta/2))^2}{1 - \tan(\beta/2)} \cot \frac{\beta}{2}; \frac{4R^3}{3} \times \right.$

$\left. \times \frac{(1 - \tan(\beta/2))^2}{1 + \tan(\beta/2)} \cot \frac{\beta}{2} \right\}$. ● Consider two cases: (1) the ball is inscribed into the pyramid and (2) the ball touches the base of the pyramid and the extensions of the nonparallel faces. 25. $\frac{2}{\pi} \times$

$\times \frac{m^2 + mn + n^2}{mn}$. 26. $\frac{a \sqrt{\cos 2\beta}}{2 \sin \beta + \sqrt{2}}$. 27. $-\frac{\pi R^3}{3} \tan^3 \alpha \tan 2\alpha$.

28. $r \cos \frac{\alpha}{2} \tan \left(\frac{\pi}{4} \pm \frac{\gamma}{2} \right)$. 29. $\frac{1}{4} \tan \alpha \cot^3 \frac{\alpha}{2}$. 30. $\arccos(1/\sqrt{5})$.

31. $(a + \sqrt{a+1})/(2\sqrt{a})$. 32. $q^2(2-q)/4$, $q \in (0; 2)$. 33. $\frac{4\sqrt{2}}{3\pi} \times$

$\times \tan \alpha \cot^3 \frac{\alpha}{2}$. 34. $\left\{ \frac{1183\pi R^3}{12\,000}; \frac{637\pi R^3}{12\,000} \right\}$. ▲ Suppose the regular

triangular pyramid $ABCD$ is inscribed into a ball of radius R with centre at the point O . The vertices of the pyramid belong to the surface of the ball and the altitude of the pyramid $[DO_1]$, where O_1 is the centre of the equilateral triangle ABC , belongs to the diameter of the given ball. Note that the figure in question has the plane of symmetry (DAD_1) , where D_1 is the intersection of (DO_1) and the surface of the ball. We have $|OD| = |OA| = R$. By the hypothesis, $|OO_1| = 0.3R$, $|D_1O_1| = 0.7R$. From the similarity of the right triangles AD_1O_1 and ADO_1 we find that $|AO_1|^2 = |D_1O_1| \cdot |DO_1| = 1.3R \cdot 0.7R = 0.91R^2$. The line segment $[O_1A]$ is the radius of the circle circumscribed about the triangle ABC ; then the radius r of the inscribed circle can be found by the formula $r = |AO_1|/2$. Let us calculate the volume V_1 of the cone inscribed into the pyramid:

$$V_1 = (\pi r^2/3) |DO_1| = 1183\pi R^3/12\,000.$$

The conditions of the problem are also satisfied by the pyramid with vertex at the point D_1 . In that case, the volume V_2 of the cone is equal to $637 \pi R^3/12\,000$.

35. $\left\{ \pi R^2(4 - \sqrt{7})/2; \frac{\pi R^2(12 - 3\sqrt{15})}{2} \right\}$. 36. $2r^2 \sin \beta$.

37. $\arccos \left(\tan \frac{\alpha}{2} \right)$. ● Show that the diagonal of the square

resulting in the section of the prism has the length equal to that of the lower diagonal of the rhombus. 38. $4r^2/(\sin \alpha \cos \beta)$. ● Prove that the area of the section of the prism S_{sec} and the area of the trapezoid lying at the base of the prism are related as $S_{\text{sec}} \cos \beta = S$.

39. $\frac{a^2 \sin \psi \sin(\gamma \pm \psi)}{4 \sqrt{3} \sin^2 \gamma \sin^2(\alpha/2)}$ for $\gamma \in [\varphi; \pi/2]$; $\alpha \in (0; 2\pi/3)$,
 $\frac{a^2 \sin \varphi \sin(\gamma - \psi)}{4 \sqrt{3} \sin^2 \gamma \sin^2(\alpha/2)}$ for $\gamma \in (\psi; \varphi)$, $\alpha \in (0; 2\pi/3)$, 0 in the other
cases; here $\varphi = \arccos\left(\frac{\tan(\alpha/2)}{\sqrt{3}}\right)$, $\psi = \arccos\left(\frac{2 \sin(\alpha/2)}{\sqrt{3}}\right)$.

● When solving the problem, take into account that $\gamma \in (0; \pi/2)$.
40. $\left\{ (3\sqrt{3}/4)k^2 \cos^2 \gamma; (\sqrt{3}/4)k^2 \cos \gamma; (\sqrt{3}/2)k^2 \cos \gamma \sqrt{1+3 \cos^2 \gamma} \right\}$,
where $\cos \gamma = 1/\sqrt{1+4 \tan^2 \beta}$. ● When solving the problem, bear
in mind that any triangular pyramid has 7 planes equidistant from
its vertices. 41. $\left\{ \frac{l^2 \cos^2 \beta}{1 + \cos^2 \beta}; \frac{3l^2 \cos \beta}{4(1 + \cos^2 \beta)} \right\}$. 42. $a^2(1 - \cot^2 \alpha) \times$
 $\times \sin \alpha$, $\alpha \in [\pi/4; \pi/2)$. ● Determine the lengths of the diagonals d_1

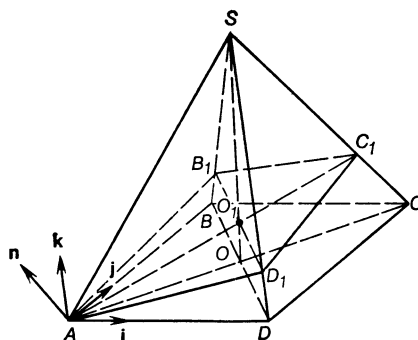

and d_2 of the section and calculate the area S of the section by the formula $S = d_1 d_2 / 2$. 43. $\frac{4r^2}{\sin^2 \alpha}$. 44. $3a^2 \sqrt{2}/5$. ▲ Let us introduce a rectangular basis (i, j, k) at the point A as shown in the figure. Suppose $\widehat{C_1 A C} = \alpha$. We consider the unit vector n perpendicular to the plane of the section $AB_1 C_1 D_1$. By the hypothesis, $\widehat{(n, j)} = 120^\circ$, and the vector n can be represented in the basis (i, j, k) as follows:

$$n = -\sin \alpha \cos 45^\circ i - \sin \alpha \cos 45^\circ j + \cos \alpha k.$$

Furthermore, we have

$$(\widehat{nj}) = \cos(n, j) = \left| -\frac{1}{2} \right| = \sin \alpha \cos 45^\circ \Rightarrow \alpha = 45^\circ.$$

After simple calculations, we find from the triangles ASC and AC_1C that $|AC_1| = 8a/5$, $|AO| = |OO_1| = a\sqrt{2}/2$, $|SO_1| = 3a\sqrt{2}/2$. From the similarity of the triangles SBD and SB_1D_1 , we find that

$|B_1D_1| = 3a\sqrt{2}/4$. Now we obtain $S = (1/2) |AC_1| |B_1D_1|$. 45. If the orthogonal projection of the section belongs to the smaller of the two parts of the base of the pyramid into which the secant plane divides the base, then the area of the section is given by the formula

$$S = \frac{a^2 \sin \alpha}{9 \sin(\alpha + \beta)} \left(2 + \frac{\sin \alpha \cos \beta}{\sin(\alpha + \beta)} \right), \quad \beta \in \left[0, \frac{\pi}{2} \right].$$

If the orthogonal projection of the section belongs to the larger part of the base, then

$$S = \frac{2a^2 \sin \alpha}{9 \sin(\alpha + \beta)} \left(1 + \frac{2 \sin \alpha \cos \beta}{\sin(\alpha + \beta)} \right), \quad \beta \in [0; \arctan(3 \tan \alpha)],$$

$$S = \frac{a^2 \sin \alpha}{9 \sin(\beta - \alpha)} \left(2 - \frac{\sin \alpha \cos \beta}{\sin(\beta - \alpha)} \right), \quad \beta \in \left[\operatorname{arccot}(3 \tan \alpha); \frac{\pi}{2} \right].$$

46. $\sqrt[3]{\frac{4V}{\sqrt{3}}}$. \blacktriangle Suppose x is the length of the side of the base

of the prism and H is the length of the lateral edge. Then $v = H \frac{x^2 \sqrt{3}}{4}$ or $H = \frac{4v}{\sqrt{3} x^2}$. Let us find the sum of the lengths

of all the edges of the prism: $S = 3H + 6x = 6x + 4\sqrt{3}v/x^2$. Thus, we have a function

$$S(x) = 6x + 4\sqrt{3}v/x^2, \quad x \in (0; \infty),$$

whose least value on the indicated interval is to be found. Let us find the critical points of the function $S(x)$. We have

$$S'(x) = 6 - 8\sqrt{3}v/x^3 = 0, \quad x = \sqrt[3]{4v/\sqrt{3}};$$

$S'(x) < 0$ on the interval $(0; \sqrt[3]{4v/\sqrt{3}})$ ($S(x)$ decreases) and

$S'(x) > 0$ on the interval $(\sqrt[3]{4v/\sqrt{3}}; \infty)$ ($S(x)$ increases). Con-

sequently, for $x = \sqrt[3]{4v/\sqrt{3}}$ the function $S(x)$ has a minimum coinciding with its least value on the interval $(0, \infty)$ being considered.

47. $\frac{H}{3}; \frac{4\pi R^2 H}{27}$. \bullet Find the largest value of the function $V(x) =$

$= \pi R^2 x \left(\frac{H-x}{H} \right)^2$ on the interval $x \in [0; H]$ (x being the length

of the altitude of the cylinder). 48. $2\sqrt{2}R/3; 4R/3$. \bullet Find the values of h , $h \in [0; 2R]$ for which the function $V(h) = \frac{\pi h^2}{3}(2R-h)$

assumes the largest value on the indicated interval ($r^2 = h(2R-h)$).

49. The cone with the radius of the base equal to $R\sqrt{2}$ and the altitude equal to $4R$. \blacktriangle Suppose r , H , φ are the radius of the base of the cone, the length of its altitude and the magnitude of the angle of inclination of the generatrix to the plane of the base respectively. We

have:

$$r = R \cot \frac{\varphi}{2}, \quad H = r \tan \varphi = R \cot \frac{\varphi}{2} \tan \varphi;$$

$$V(\varphi) = \frac{\pi R^3}{3} \tan \varphi \cot^3 \frac{\varphi}{2},$$

$$\varphi \in \left(0, \frac{\pi}{2}\right).$$

We introduce a new variable $t = \tan(\varphi/2)$ and differentiate the function obtained. Then we have

$$V(t) = \frac{2\pi R^3}{3} \cdot \frac{1}{(1-t^2)t^3}, \quad t \in (0, 1),$$

$$V'(t) = \frac{2\pi R^3}{3} \cdot \frac{2(2t^2-1)}{(1-t^2)^2 t^3}.$$

We have $V'(1/\sqrt{2}) = 0$ at the point $t = 1/\sqrt{2}$, $V'(t) < 0$ on the interval $(0; 1/\sqrt{2})$, and $V'(t) > 0$ on the interval $(1/\sqrt{2}; 1)$, i.e. at the point $t = 1/\sqrt{2}$ the function $V(t)$ has a minimum coinciding with its least value on the indicated interval $t \in (0; 1)$. Next we find:

$$r = R \sqrt{2} \text{ and } H = R \cdot \sqrt{2} \frac{2 \cdot 1 \sqrt{2}}{1-1/2} = 4R. \quad 50. \quad R \sqrt{3}. \quad 51. \quad \frac{4}{3} R;$$

$$\frac{64}{81} R^3. \quad 52. \quad \frac{H}{3}; \quad \frac{2\sqrt{3}}{9} R^2 H. \quad 53. \quad \pi/4. \quad 54. \quad k^2 \sin 2\alpha \text{ for } \alpha \in$$

$$\in \left(\operatorname{arccot} \frac{1}{2}; \frac{\pi}{2} \right), \quad \frac{1}{2} k^2 (1 + 3 \cos^2 \alpha) \text{ for } \alpha \in \left(0; \operatorname{arccot} \frac{1}{2} \right].$$

▲When the cone is cut

by the plane passing through its vertex, an isosceles triangle results in the section whose area is S ; $S = \frac{1}{2} l^2 \sin \varphi$, where l is the length

of the generatrix of the cone, φ is the magnitude of the angle between the generatrices along which the plane cuts the conical surface. Since the length of the generatrix is equal to the length of the lateral edge of the pyramid, inscribed into that cone, the area of the section is a function of the angle φ with $\varphi \in (0; \pi)$ in the general case.

The largest value of φ is the angle γ in the axial section of the cone and, therefore, when investigating the sign of the derivative of the function $S'(\varphi) = \frac{1}{2} l^2 \cos \varphi$, we have two possibilities: (1) if $\gamma \in (0; \pi/2)$, then $\cos \varphi > 0$ and $S(\varphi)$ increases on this interval and attains its greatest value at $\varphi = \gamma$; in that case, $S_{\max} = \frac{1}{2} l^2 \sin \gamma$;

(2) if $\gamma \in [\pi/2; \pi)$, then $\cos \varphi \leq 0$, and $\varphi = \pi/2$ is a point of maximum of the function $S(\varphi)$ and, therefore, $S_{\max} = l^2/2$ in this case.

Suppose β is the magnitude of the angle between the lateral edge of the pyramid and the plane of the base, h is the length of its altitude. We have: $h \cot \beta = 2h \cot \alpha$ or $\cot \beta = 2 \cot \alpha$ and $h = k \sin \alpha$.

Let us find now the length of the generatrix of the cone (of the lateral edge of the pyramid): $l = h/\sin \beta$. We can now find the expression for the area of the section:

$$S_{\text{sec}} = \frac{1}{2} \left(\frac{h}{\sin \beta} \right)^2 \sin \varphi = \frac{1}{2} k^2 \sin^2 \alpha (1 + 4 \cot^2 \alpha) \sin \varphi.$$

The magnitude of the angle γ in the axial section of the cone is less than $\pi/2$ if $\beta > \pi/4$, i.e. $2 \cot \alpha < 1$ or $\alpha \in \left(\operatorname{arccot} \frac{1}{2}; \frac{\pi}{2} \right)$; in this case

$$S_{\text{max}} = \frac{1}{2} k^2 \sin^2 \alpha 2 \cot \beta = 2k^2 \sin^2 \alpha \cot \alpha = k^2 \sin 2\alpha.$$

Now if $0 < \beta \leq \pi/4$, i.e. for $\alpha \in (0, \operatorname{arccot} (1/2)]$,

$$S_{\text{max}} = \frac{1}{2} l^2 = \frac{1}{2} k^2 \sin^2 \alpha (1 + 4 \cot^2 \alpha) = \frac{k^2}{2} (1 + 3 \cos^2 \alpha).$$

8.3. Volumes of Solids of Revolution

1. $\frac{\pi a^3 \sin^2 \alpha \sin^2 \beta}{3 \sin^2 (\alpha + \beta)}$. 2. $\frac{\pi b^3}{12} (\tan^2 \alpha - \tan^2 \beta)$.
 3. $\frac{\pi a^3 \sin^2 \alpha \sin (\alpha + \beta)}{\sin \beta}$. 4. $3\pi/10$. 5. $\pi/5$. 6. (a) 5π . $\blacktriangle V =$

$$= \pi \int_0^3 (|x-1| - 2)^2 dx = \pi \int_0^1 (-x+1-2)^2 dx + \pi \int_1^3 (x-1-2)^2 dx = \frac{\pi (x+1)^3}{3} \Big|_0^1 + \frac{\pi (x-3)^3}{3} \Big|_1^3 = 5\pi. \text{ We have used the relations } |f(x)|^2 = (f(x))^2 \text{ and}$$

$$|x-1| - 2 = \begin{cases} -x-1, & x \in (-\infty; 1), \\ x-3, & x \in [1; \infty); \end{cases}$$

(b) $32\pi/3$. \blacktriangle The volume V will be found with due account of the fact that

$$|x-1| - |x+1| = \begin{cases} 2, & x \in (-\infty; -1), \\ -2x, & x \in [-1; 1), \\ -2, & x \in [1; \infty). \end{cases}$$

$$V = \pi \int_{-2}^3 (|x-1| - |x+1|)^2 dx = \pi \int_{-2}^{-1} 4 dx + \pi \int_{-1}^1 4x^2 dx + \pi \int_1^2 4 dx;$$

(c) $18\pi/5$; (d) 2.1π ; (e) 8π . 7. The diagonal of a square is perpendicular to the axis of revolution. ● Denoting the length of the side of the square by a , and the magnitude of the angle formed by one of the sides of the square and the axis of revolution, by α , show that the volume of the resulting solid of revolution is equal to

$$\pi a^3 (\sin \alpha + \cos \alpha).$$

Chapter 9

MISCELLANEOUS PROBLEMS

9.1. Problems in Algebra

1. $A = \{1; 2; a; 5\}$, if $a \neq 1$, $a \neq 2$, $a \neq 5$; $A = \{1; 2; 5\}$, if $a = 1$, or $a = 2$, or $a = 5$; $B = \emptyset$, if $a \neq 1$ or $a \neq 2$; $B = \{1\}$, if $a = 1$; $B = \{2\}$, if $a = 2$. 2. ● Prove that among three consecutive natural numbers one number is a multiple of 2 and one number is a multiple of 3. 3. ● Show that the square of any integer cannot have the digit 2 in the units place. 4. 11. 5. 17. 6. ▲ Let us assume the contrary, i.e. $\log_2 5 = m/n$, where $m, n \in \mathbb{N}$. Then $2^{m/n} = 5$ or $2^m = 5^n$, which is impossible since 2^m is an even number for any $m \in \mathbb{N}$, and 5^n is an odd number for any $n \in \mathbb{N}$. Thus, our assumption is wrong and, therefore the number $\log_2 5$ is not rational. 7. $a < 0$. 8. $1/2$. ▲ $a^4 + b^4 + c^4 = (a^2 + b^2)^2 + c^4 - 2(ab)^2 = (1 - c^2)^2 + c^4 - 2((2c^2 - 1)/2)^2 = 2c^4 - 2c^2 + 1 - 2c^4 + 2c^2 - 1/2 = 1/2$.

9. (a) ▲ We carry out the proof by mathematical induction. For $n = 1$ we have $1^2 = \frac{1 \cdot 2 \cdot 3}{6}$, i.e. the inequality holds true. Let us now assume that the formula holds for $n = k$ and prove its validity for $n = k + 1$. Since

$$\begin{aligned} 1^2 + 2^2 + 3^2 + \dots + k^2 &= \frac{k(k+1)(2k+1)}{6}, \text{ it follows that } (1^2 + 2^2 + \\ &+ 3^2 + \dots + k^2) + (k+1)^2 = \frac{k(k+1)(2k+1)}{6} + (k+1)^2 = \\ &= \frac{(k+1)(k+2)(2k+3)}{6} \text{ and this means that the formula is valid} \end{aligned}$$

for any $n \in \mathbb{N}$. (b) ● Carry out the proof by mathematical induction.

10. (a) $\frac{n(n+1)(n+2)}{6}$. ● Note that

$$\begin{aligned} S_n &= \frac{1}{2} (1^2 + 1 + 2^2 + 2 + 3^2 + 3 + \dots + n^2 + n) \\ &= \frac{1}{2} ((1 + 2 + 3 + \dots + n) + (1^2 + 2^2 + 3^2 + \dots + n^2)), \end{aligned}$$

and make use of the result of problem 9 (a); (b) $(n(n+1)/2)^2$. \blacktriangle Let us write n obvious identities:

$$\begin{aligned}(1+1)^4 &= 2^4 = 1^4 + 4 \cdot 1^3 \cdot 1 + 6 \cdot 1^2 \cdot 1^2 + 4 \cdot 1 \cdot 1^3 + 1^4, \\(2+1)^4 &= 3^4 = 2^4 + 4 \cdot 2^3 \cdot 1 + 6 \cdot 2^2 \cdot 1^2 + 4 \cdot 2 \cdot 1^3 + 1^4, \\(3+1)^4 &= 4^4 = 3^4 + 4 \cdot 3^3 \cdot 1 + 6 \cdot 3^2 \cdot 1^2 + 4 \cdot 3 \cdot 1^3 + 1^4, \\&\vdots \\(n+1)^4 &= n^4 + 4 \cdot n^3 \cdot 1 + 6 \cdot n^2 \cdot 1^2 + 4 \cdot n \cdot 1^3 + 1^4.\end{aligned}$$

Adding together all the n rows and collecting like terms, we get

$$\begin{aligned}(n+1)^4 &= 4(1^3 + 2^3 + 3^3 + \dots + n^3) + 6(1^2 + 2^2 + 3^2 + \dots \\&\quad \dots + n^2) + 4(1 + 2 + \dots + n) + (n+1),\end{aligned}$$

whence we have

$$\begin{aligned}1^3 + 2^3 + \dots + n^3 &= \frac{1}{4} \left((n+1)^4 - \frac{6n(n+1)(2n+1)}{6} \right. \\&\quad \left. - 4 \frac{n(n+1)}{2} - (n+1) \right).\end{aligned}$$

After simple transformations of the right-hand side, we get the answer. **11.** \blacktriangle Suppose $xy = 1$, then $y = 1/x$. We have to prove that $A \geq 2$ provided that $x + 1/x = A$. Let us consider the difference $A - 2 = x + 1/x - 2 = (x-1)^2/x$; this difference is non-negative for all $x > 0$; consequently, $A \geq 2$. **12.** \blacktriangle We have $x_1 x_2 x_3 \dots x_n = 1$, $x_i > 0$, $i = 1, 2, \dots, n$. Let us prove that $x_1 + x_2 + x_3 + \dots + x_n \geq n$, with $x_1 + x_2 + x_3 + \dots + x_n > n$, if the numbers $x_1, x_2, x_3, \dots, x_n$ are not all identical. We carry out the proof by induction. For $n = 1, 2$ the assertion is true (if $n = 1$, then $x_1 = 1$ and $1 \geq 1$; for $n = 2$ the truth of the assertion follows from the solution of the preceding problem).

Let us assume that the assertion is true for $n = k \geq 2$, i.e. that the inequality $x_1 + x_2 + x_3 + \dots + x_k \geq k$ is valid, if $x_1 x_2 x_3 \dots x_k = 1$ and prove that $x_1 + x_2 + x_3 + \dots + x_{k+1} \geq k + 1$, if $x_1 x_2 x_3 \dots x_{k+1} = 1$. Suppose that not all the terms x_1, x_2, \dots, x_{k+1} are identical (in the case $x_1 = x_2 = x_3 = \dots = x_{k+1} = 1$ the proof is obvious $x_1 + x_2 + \dots + x_{k+1} = k + 1$). Then, among the terms, there can be found numbers both larger and smaller than unity (all the terms cannot be smaller than unity since in that case their product is smaller than unity). We assume that $x_1 > 1$ and $x_{k+1} < 1$. We have $(x_1 x_{k+1}) x_2 x_3 \dots x_k = 1$. Setting $x_1 x_{k+1} = y_1$, we obtain $y_1 x_2 x_3 \dots x_k = 1$. Since the product of k positive numbers is equal to unity, their sum (according to the supposition of induction) is not smaller than k :

$$y_1 + x_2 + x_3 + \dots + x_k \geq k,$$

whence we have

$$\begin{aligned}&x_1 + x_2 + x_3 + \dots + x_{k+1} \\&= (y_1 + x_2 + x_3 + \dots + x_k) - y_1 + x_1 + x_{k+1} \\&\geq k - y_1 + x_1 + x_{k+1} = (k+1) - 1 - x_1 x_{k+1} + x_1 + x_{k+1} \\&= k + 1 + (x_{k+1} - 1)(1 - x_1).\end{aligned}$$

And since $x_1 > 1$ and $x_{k+1} < 1$, it follows that $(x_{k+1} - 1)(1 - x_1) > 0$ and, therefore,

$$\begin{aligned} & x_1 + x_2 + x_3 + \dots + x_{k+1} \\ & \geq (k+1) + (x_{k+1} - 1)(1 - x_1) > k+1. \end{aligned}$$

This completes the proof of the assertion of the problem. **13. ▲** Suppose

$$\frac{x_1 + x_2 + x_3 + \dots + x_n}{n} = a, \quad \sqrt[n]{x_1 x_2 x_3 \dots x_n} = b.$$

From the last equality we have

$$\sqrt[n]{\frac{x_1}{b} \cdot \frac{x_2}{b} \cdot \frac{x_3}{b} \dots \frac{x_n}{b}} = 1 \quad \text{or} \quad \frac{x_1}{b} \cdot \frac{x_2}{b} \cdot \dots \cdot \frac{x_n}{b} = 1.$$

Since the product of n positive numbers is equal to unity, it follows (see problem 12) that their sum is not smaller than n , i.e.

$$\frac{x_1}{b} + \frac{x_2}{b} + \dots + \frac{x_n}{b} \geq n.$$

Multiplying both sides of the inequality by b and dividing by n , we obtain

$$a = \frac{x_1 + x_2 + \dots + x_n}{n} \geq b,$$

and that is what we had to prove. *Remark.* The equality sign occurs only in the case when $\frac{x_1}{b} = \frac{x_2}{b} = \dots = \frac{x_n}{b} = 1$, i.e. when all the numbers x_i , $i = 1, 2, 3, \dots, n$ are equal. **14. ▲** Using the result of the preceding problem, we have

$$\begin{aligned} & \sqrt[n]{n!} = \sqrt[n]{1 \cdot 2 \cdot 3 \dots n} \\ & < \frac{1+2+3+\dots+n}{n} = \frac{(n+1)n}{2n} = \frac{n+1}{2}. \end{aligned}$$

Raising both parts of the last inequality to the n th degree, we get the original inequality. **15. ▲** We prove the inequality using mathematical induction. For $n = 1$ we have $1 + x_1 \geq 1 + x_1$. We have one of the relations, " $>$ " or " $=$ ": consequently, the assertion is true. Suppose the inequality holds for $n = k$, $k \in \mathbb{N}$. Let us prove that it also holds for $n = k + 1$, i.e.

$$\begin{aligned} & ((1 + x_1)(1 + x_2) \dots (1 + x_k))(1 + x_{k+1}) \\ & \geq (1 + x_1 + x_2 + \dots + x_k) + x_{k+1}. \end{aligned}$$

Replacing the sum $1 + x_1 + x_2 + \dots + x_k$ on the right-hand side of the inequality by the product $(1 + x_1)(1 + x_2) \dots (1 + x_k)$ (the inequality becomes stronger) and transferring all the terms of the inequality into the left-hand side, we obtain an obvious inequality $[(1 + x_1)(1 + x_2) \dots (1 + x_k) - 1]x_{k+1} \geq 0$. *Remark.* For $x_1 = x_2 = \dots = x_n = x$, the original inequality assumes the form

$$(1 + x)^n \geq 1 + nx, \quad x > -1$$

(Bernoulli's inequality). 16. (a) \blacktriangle Assume $\frac{1}{2} \cdot \frac{3}{4} \cdot \frac{5}{6} \cdots \frac{99}{100} = \Pi_1$, and $\frac{2}{3} \cdot \frac{4}{5} \cdot \frac{6}{7} \cdots \frac{100}{101} = \Pi_2$. Since $\frac{1}{2} < \frac{2}{3}$, $\frac{3}{4} < \frac{4}{5}$, \dots , $\frac{99}{100} < \frac{100}{101}$, we have $\Pi_1^2 < \Pi_1 \Pi_2 = \frac{1}{101}$; consequently, $\Pi_1 < \frac{1}{\sqrt{101}} < \frac{1}{10}$. We have proved the assertion. (b) \bullet Carry out the proof by induction. (c) \bullet Set $n = 50$ in the inequality in (b) and use the inequality $\frac{1}{\sqrt{151}} < \frac{1}{\sqrt{144}} = \frac{1}{12}$. 17. \bullet Carry out the proof by induction. 18. \blacktriangle

We carry out the proof by induction. For $n = 1$ the assertion is true: $|\sin \alpha| \leq |\sin \alpha|$. Assume that the inequality $|\sin k\alpha| \leq k|\sin \alpha|$ is satisfied for $n = k$. Let us prove that $|\sin(k+1)\alpha| \leq (k+1)|\sin \alpha|$ for $n = k+1$. Using the formula for the sine of the sum of two angles and the inequalities $|a+b| \leq |a| + |b|$, $|\cos \alpha| \leq 1$, $|\cos k\alpha| \leq 1$, we obtain

$$\begin{aligned} |\sin(k+1)\alpha| &= |\sin k\alpha \cos \alpha + \cos k\alpha \sin \alpha| \\ &\leq |\sin k\alpha \cos \alpha| + |\cos k\alpha \sin \alpha| \leq |\sin k\alpha| + |\sin \alpha|. \end{aligned}$$

And since $|\sin k\alpha| \leq k|\sin \alpha|$ by the supposition of induction, we have $|\sin(k+1)\alpha| \leq |\sin k\alpha| + |\sin \alpha| \leq k|\sin \alpha| + |\sin \alpha| = (k+1)|\sin \alpha|$. 19. (a) \blacktriangle Since $\tan \alpha > \alpha$ for $\alpha \in (0; \pi/2)$ and $\frac{1+a}{1-a} > \frac{1+b}{1-b}$ for $0 < b < a < 1$, we have

$$\begin{aligned} \tan(-314^\circ) &= \tan 46^\circ = \tan(45^\circ + 1^\circ) \\ &= \frac{1 + \tan \frac{\pi}{180}}{1 - \tan \frac{\pi}{180}} > \frac{1 + \frac{\pi}{180}}{1 - \frac{\pi}{180}} > \frac{1 + \frac{3}{180}}{1 - \frac{3}{180}} = \frac{61}{59}. \end{aligned}$$

(b) \blacktriangle Suppose $ABCD$ is a curvilinear trapezoid bounded by the lines $y = 1/x$, $x = 5$, $x = 7$ and $y = 0$ (see the figure). Then,

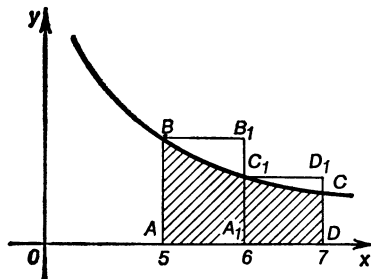

$\ln \frac{7}{5} = \int_5^7 \frac{dx}{x}$. But $S_{ABCD} < S_{ABB_1A_1} + S_{A_1C_1D_1D} = \frac{1}{5} \times 1 + \frac{1}{6} \times 1 = \frac{11}{30}$ (here $|AB| = 1/5$, $|AA_1| = |A_1D| = 1$, $|C_1A_1| = 1/6$), i.e. $\ln \frac{7}{5} <$

$< \frac{1}{5} + \frac{1}{6} = \frac{11}{30}$. 20. (a) $D = D_1 \cap D_2$; (b) if D_1 and D_2 coincide.

21. $-7/4$. ● Substitute $x = 2$ and $x = 1/2$ in the given equality and exclude $f(1/2)$ from the numerical equalities. 22. The straight line $y = x$ with the points $O(0; 0)$ and $A(1; 1)$ excluded.

23.

23. (a)

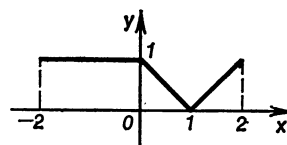
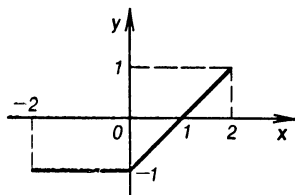

23. (b)

23. (c)

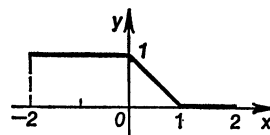
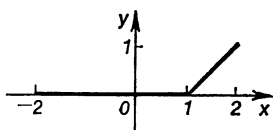

23. (d)

23. (e)

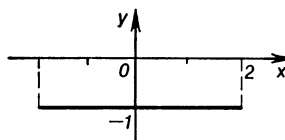
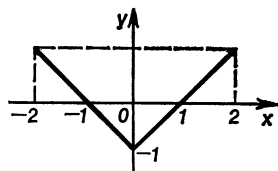

24. No, we cannot. The function $f(x) = x$, for instance, increases on the interval $(-1; 0)$ and the function $\varphi(x) = x^2$ decreases on that interval. 25. ▲ Since for any $x_1, x_2 \in (a; b)$ and such that $x_2 > x_1$, $f_1(x_1) > f_1(x_2)$ and $f_2(x_1) > f_2(x_2)$ it follows that $f_1(x_1) + f_2(x_1) > f_1(x_2) + f_2(x_2)$ or $\varphi(x_1) > \varphi(x_2)$, and this means that the function $\varphi(x)$ decreases on that interval. 26. ● Carry out the proof by induction. 27. Yes, it can. For instance, if $f_1(x) = x - \sqrt{x^2 + 1}$ and $f_2(x) = x + \sqrt{x^2 + 1}$, then $\varphi(x) = -1$ is a periodic function, whose period is any number $T \in \mathbb{R}$, except for $T = 0$. 28. ● Use the definitions of an even and an odd function. 29. ● Use the assertions of the preceding problem. 30. ▲ Suppose $f(x)$ is an even function defined on an interval $(-a, a)$ and $x \in (-a, a)$. Then, by the definition, $-x \in (-a, a)$ as well. Let us assume that $x > 0$. Then $-x < x$, and, by virtue of the strict monotonicity, either $f(-x) < f(x)$ (the function is strictly increasing) or $f(-x) > f(x)$ (the function is

strictly decreasing). On the other hand, the function $f(x)$ being even, we have $f(-x) = f(x)$, which fact leads to a contradiction. 31. $f(x) = 0$. \blacktriangle By the definition of an even function, we have $f(x) = f(-x)$, and by the definition of an odd function, $f(x) = -f(-x)$. Consequently, $f(-x) = -f(-x)$, which is only possible for $f(-x) = 0$, but then $f(x) = f(-x) = 0$ as well, and this means that the required function assumes zero values for all $x \in \mathbb{R}$. 32. (a)-(c). \bullet The proofs of these theorems follow directly from the definitions of an even and an odd function. 33. \blacktriangle Since, by the hypothesis, $f(x)$ is an even function, it follows that $y = f(x) = f(-x)$, i.e. the function assumes one and the same value y at least at two points. Consequently, the correspondence between $D(f)$ and $E(f)$ is irreversible. 34. \bullet Prove that the equality $f(x) = f(x+T)$ is responsible for the irreversibility of the correspondences between $D(f)$ and $E(f)$.

9.2. Limit of a Function. Continuity

1. 2/3. $\blacktriangle \lim_{x \rightarrow 1} \frac{x^2-1}{2x^2-x-1} = \lim_{x \rightarrow 1} \frac{(x-1)(x+1)}{2(x-1)\left(x+\frac{1}{2}\right)} = \lim_{x \rightarrow 1} \frac{x+1}{2x+1} = \frac{2}{3}$. 2. 3/2. \bullet Factor the numerator and the denominator of the fraction. 3. -7.2. 4. 3. \bullet Simplify the expression in brackets. 5. 1, 2. \blacktriangle Since $\lim_{x \rightarrow \infty} \frac{1}{x} = 0$, we obtain

$$\begin{aligned} \lim_{x \rightarrow \infty} \left(\frac{3x}{5x-1} \cdot \frac{2x^2+1}{x^2+2x-1} \right) &= \lim_{y \rightarrow 0} \left(\frac{\frac{3}{y}}{\frac{5}{y}-1} \cdot \frac{\frac{2}{y^2}+1}{\frac{1}{y^2}+\frac{2}{y}-1} \right) \\ &= \lim_{y \rightarrow 0} \left(\frac{3}{5-y} \cdot \frac{2+y^2}{1+2y-y^2} \right) = \frac{3}{5} \cdot 2 = 1.2, \end{aligned}$$

by setting $x = 1/y$. 6. 2/9. \odot Add the fractions together and set $x = 1/y$. 7. -3. \bullet Factor the numerator and the denominator of the fraction. 8. 3/4. 9. 3.

$$\begin{aligned} \blacktriangle \lim_{x \rightarrow 1} \frac{x^2 - \sqrt{x}}{\sqrt{x} - 1} &= \lim_{x \rightarrow 1} \frac{\sqrt{x}(\sqrt{x^3} - 1)}{\sqrt{x} - 1} = \lim_{x \rightarrow 1} \sqrt{x}(x + \sqrt{x} + 1) = 3. \\ 10. \frac{1}{16}. \quad \blacktriangle \lim_{x \rightarrow 2} \frac{x - \sqrt{3x-2}}{x^2-4} &= \lim_{x \rightarrow 2} \frac{x^2 - (3x-2)}{(x^2-4)(x + \sqrt{3x-2})} = \\ &= \lim_{x \rightarrow 2} \frac{(x-2)(x-1)}{(x-2)(x+2)(x + \sqrt{3x-2})} = \lim_{x \rightarrow 2} \frac{x-1}{(x+2)(x + \sqrt{3x-2})} = \\ &= \frac{1}{(2+2)(2+2)} = \frac{1}{16}. \quad 11. \frac{1}{2}. \quad \blacktriangle \lim_{x \rightarrow 1} \frac{\sqrt{5-x}-2}{\sqrt{2-x}-1} = \\ &= \lim_{x \rightarrow 1} \frac{(5-x-4)(\sqrt{2-x}+1)}{(2-x-1)(\sqrt{5-x}+2)} = \lim_{x \rightarrow 1} \frac{\sqrt{2-x}+1}{\sqrt{5-x}+2} = \frac{1}{2}. \end{aligned}$$

12. $\frac{1}{4a\sqrt{a-b}}$. • Multiply the numerator and the denominator

of the fraction by $\sqrt{x-b} + \sqrt{a-b}$. 13. $\frac{3}{2}$. ▲ $\lim_{x \rightarrow 1} \frac{\sqrt{x}-1}{\sqrt[3]{x}-1} =$

$$= \lim_{x \rightarrow 1} \frac{(x-1)(\sqrt[3]{x^2} + \sqrt[3]{x} + 1)}{(x-1)(\sqrt{x}+1)} = \lim_{x \rightarrow 1} \frac{\sqrt[3]{x^2} + \sqrt[3]{x} + 1}{\sqrt{x}+1} = \frac{3}{2}. \quad \text{14. 1.2.}$$

• Multiply the numerator and the denominator of the fraction by $(\sqrt{1+x} + \sqrt{1-x})(\sqrt[3]{(1+x)^2} + \sqrt[3]{1-x}\sqrt[3]{1+x} + \sqrt{(1-x)^2})$.

15. a^2 . ▲ Let us simplify the expression in brackets. Setting $\sqrt[4]{a} = b$, $\sqrt[4]{x} = y$ (to make the transformations more convenient) we obtain

$$\begin{aligned} & \left(\frac{b^2+y^2}{b-y} \right)^{-1} \frac{2by}{y^3-by^2+b^2y-b^3} \\ &= \frac{b-y}{b^2+y^2} \frac{2by}{(y-b)(b^2+y^2)} = \frac{1}{b-y}. \end{aligned}$$

And since $\sqrt[2]{2^{\log_2 a}} = \sqrt[4]{a} = b$, the expression in braces assumes the form $b-y-b = -y = -\sqrt[4]{x}$. Then we find the limit:

$$\lim_{x \rightarrow a} (-\sqrt[4]{x})^8 = \lim_{x \rightarrow a} x^2 = a^2.$$

16. 8. ▲ We set $2^{x/2} = y$, and then we have

$$\begin{aligned} \lim_{x \rightarrow 2} \frac{2^x + 2^{3-x} - 6}{2 - \frac{x}{2} - 2^{1-x}} &= \lim_{y \rightarrow 2} \frac{y^2 + \frac{8}{y^2} - 6}{\frac{1}{y} - \frac{2}{y^2}} = \lim_{y \rightarrow 2} \frac{y^4 - 6y^2 + 8}{y-2} \\ &= \lim_{y \rightarrow 2} \frac{(y-2)(y+2)(y^2-2)}{y-2} = \lim_{y \rightarrow 2} (y+2)(y^2-2) = 4 \cdot 2 = 8. \end{aligned}$$

17. $\frac{1}{\sqrt{3}}$.

$$\begin{aligned} \text{▲ } \lim_{x \rightarrow \frac{\pi}{3}} \frac{\sin\left(x - \frac{\pi}{3}\right)}{1 - 2 \cos x} &= \lim_{x \rightarrow \frac{\pi}{3}} \frac{2 \sin\left(\frac{x}{2} - \frac{\pi}{6}\right) \cos\left(\frac{x}{2} - \frac{\pi}{6}\right)}{2\left(\cos \frac{\pi}{3} - \cos x\right)} \\ &= \lim_{x \rightarrow \frac{\pi}{3}} \frac{\sin\left(\frac{x}{2} - \frac{\pi}{6}\right) \cos\left(\frac{x}{2} - \frac{\pi}{6}\right)}{2 \sin\left(\frac{x}{2} - \frac{\pi}{6}\right) \sin\left(\frac{x}{2} + \frac{\pi}{6}\right)} = \lim_{x \rightarrow \frac{\pi}{3}} \frac{\cos\left(\frac{x}{2} - \frac{\pi}{6}\right)}{2 \sin\left(\frac{x}{2} + \frac{\pi}{6}\right)} \\ &= \frac{\cos 0}{2 \sin\left(\frac{\pi}{6} + \frac{\pi}{6}\right)} = \frac{1}{2 \frac{\sqrt{3}}{2}} = \frac{1}{\sqrt{3}}. \end{aligned}$$

$$\begin{aligned}
18. -24. \quad \blacktriangle \lim_{x \rightarrow \frac{\pi}{3}} \frac{\tan^3 x - 3 \tan x}{\cos \left(x + \frac{\pi}{6}\right)} &= \lim_{x \rightarrow \frac{\pi}{3}} \frac{\tan x \left(\tan^2 x - \tan^2 \frac{\pi}{3}\right)}{\cos \left(x + \frac{\pi}{6}\right)} = \\
&= \lim_{x \rightarrow \frac{\pi}{3}} \frac{\tan x \sin \left(x + \frac{\pi}{3}\right) \sin \left(x - \frac{\pi}{3}\right)}{\cos \left(x + \frac{\pi}{6}\right) \cos^2 x \cos^2 \frac{\pi}{3}} = \\
&= 4 \lim_{x \rightarrow \frac{\pi}{3}} \left(\frac{-\tan x \sin \left(x + \frac{\pi}{3}\right)}{\cos^2 x} \right) = 4 \cdot \sqrt{3} \cdot 4 \left(-\frac{\sqrt{3}}{2} \right) = -24.
\end{aligned}$$

$$\begin{aligned}
19. \frac{2}{\sqrt{3}}. \quad \blacktriangle \lim_{x \rightarrow \pi/6} \frac{1 - 4 \sin^2 x}{\cos 3x} &= \lim_{x \rightarrow \pi/6} \frac{4(0.25 - \sin^2 x)}{4 \cos x (\cos^2 x - 0.75)} = \\
&= \lim_{x \rightarrow \pi/6} \left(\frac{1}{\cos x} \right) = \frac{2}{\sqrt{3}}. \quad 20. 0.4. \quad \blacktriangle \lim_{x \rightarrow 0} \frac{\sin 2x}{5x} = \lim_{x \rightarrow 0} \frac{2}{5} \frac{\sin 2x}{2x}.
\end{aligned}$$

Setting $2x = y$, we obtain $\lim_{x \rightarrow 0} \frac{\sin 2x}{2x} = \lim_{y \rightarrow 0} \frac{\sin y}{y} = 1$. Multiplying the limits $2/5$ and 1 , we get the answer. 21. $8/3$. Deduce the expression $\sin 8x \cot 3x$ to the form $\frac{8}{3} \frac{\sin 8x}{8x} \frac{3x}{\sin 3x} \cos 3x$, calculate

the limits $\lim_{x \rightarrow 0} \frac{\sin 8x}{8x}$, $\lim_{x \rightarrow 0} \frac{3x}{\sin 3x}$, $\lim_{x \rightarrow 0} \cos 3x$ and apply the theorem on the limit of the product of a finite number of functions having a limit at a given point. 22. $-1/2$. ● $\frac{x^2 + 3x - 1}{x^2 + 2x} \tan x =$
 $= \frac{x^2 + 3x - 1}{(\cos x)(x + 2)} \frac{\sin x}{x}$. 23. 5. ● Set $x - 1 = y$ and use the fact

that $\lim_{y \rightarrow 0} \frac{\sin y}{y} = 1$. 24. -1 . 25. $25/6$. 26. 0 for $n = 1$; 4.9 for $n = 2$. 27. $-\sin a$. ● Transform the expression $[\sin(a + 2x) - \sin(a + x)] -$
 $-\sin(a + x) + \sin a$ into a product. 28. $1/4$.

$$\begin{aligned}
\blacktriangle \lim_{x \rightarrow 0} \frac{\sqrt{1 + \tan x} - \sqrt{1 + \sin x}}{x^3} &= \lim_{x \rightarrow 0} \frac{(1 + \tan x) - (1 + \sin x)}{x^3 (\sqrt{1 + \tan x} + \sqrt{1 + \sin x})} = \\
&= \lim_{x \rightarrow 0} \frac{\tan x (1 - \cos^2 x)}{x^3 (1 + \cos x) (\sqrt{1 + \tan x} + \sqrt{1 + \sin x})} = \lim_{x \rightarrow 0} \frac{\sin^3 x}{x^3} \times \\
&\times \frac{1}{\cos x (1 + \cos x) (\sqrt{1 + \tan x} + \sqrt{1 + \sin x})} = \frac{1}{1(1+1)(1+1)} = \\
&= \frac{1}{4}. \quad 29. 1/2. \quad \blacktriangle \text{ We represent the given function } f(x) \text{ in the form}
\end{aligned}$$

$$f(x) = \frac{\sqrt[3]{1+x^2} - 1 + 1 - \sqrt[4]{1-2x}}{x+x^2} = \frac{\sqrt[3]{1+x^2} - 1}{x+x^2} + \frac{1 - \sqrt[4]{1-2x}}{x+x^2}.$$

Now we can calculate the limits:

$$\begin{aligned} \lim_{x \rightarrow 0} f_1(x) &= \lim_{x \rightarrow 0} \frac{\sqrt[3]{1+x^2}-1}{x+x^2} \\ &= \lim_{x \rightarrow 0} \frac{1+x^2-1}{x(x+1)(\sqrt[3]{(1+x^2)^2}+\sqrt[3]{1+x^2}+1)} \\ &= \lim_{x \rightarrow 0} \frac{x}{(x+1)(\sqrt[3]{(1+x^2)^2}+\sqrt[3]{1+x^2}+1)} = 0, \\ \lim_{x \rightarrow 0} f_2(x) &= \lim_{x \rightarrow 0} \frac{1-\sqrt[4]{1-2x}}{x(1+x)} \\ &= \lim_{x \rightarrow 0} \frac{1-(1-2x)}{x(1+x)(1+\sqrt[4]{1-2x})(1+\sqrt{1-2x})} \\ &= \lim_{x \rightarrow 0} \frac{2}{(1+x)(1+\sqrt[4]{1-2x})(1+\sqrt{1-2x})} = \frac{2}{1(1+1)(1+1)} = \frac{1}{2}. \end{aligned}$$

Next we find $\lim_{x \rightarrow 0} f(x) = \lim_{x \rightarrow 0} f_1(x) + \lim_{x \rightarrow 0} f_2(x) = 0 + \frac{1}{2} = \frac{1}{2}$.

30. (a) $\{-3; 3\}$; (b) $\{0\}$; (c) $\{0\}$; (d) $\{0\}$; (e) $\{\pi/2 + n\pi \mid n \in \mathbb{Z}\}$; (f) $\{n \mid n \in \mathbb{Z}\}$.
31. No, it is not. 32. 4.

9.3. The Derivative of a Function

1. (a) We can; (b) we cannot. 2. (a) We cannot; the function $f(x) = x$, for instance, is differentiable at the point $x_0 = 0$, and the function $f_2(x) = |x|$ is not, nevertheless, $\varphi(x) = x|x|$ is differentiable at the point $x_0 = 0$; (b) we cannot. ● Consider the functions $f_1(x) = |x|$, $f_2(x) = |x|$. 3. ▲ Suppose $f(x)$ is a differentiable even function. Then, $f'(x) = -f'(-x)$, i.e. if $f'(x) = \varphi(x)$, then $\varphi(x) = -\varphi(-x)$, and that is what we had to prove. 4. ● The solution of this problem is similar to that of problem 3. 5. ▲ Suppose $f(x)$ is a differentiable periodic function with period T . Then $f'(x) = f'(x \pm T)$, i.e. if $f'(x) = \varphi(x)$, then $f'(x \pm T) = \varphi(x \pm T)$, and this means that $\varphi(x)$ is a periodic function with period T . 6. ▲ Since $f(0) = 0$, we have

$$\frac{f(x)}{x} = \frac{f(x)-f(0)}{x-0} \quad \text{and} \quad \lim_{x \rightarrow 0} \frac{f(x)}{x} = \lim_{x \rightarrow 0} \frac{f(x)-f(0)}{x-0} = f'(0).$$

7. ▲ We represent the relation $\frac{f(x)}{g(x)}$ in the form

$$\frac{f(x)}{g(x)} = \frac{\frac{f(x)-f(0)}{x-0}}{\frac{g(x)-g(0)}{x-0}}$$

(this is legitimate since $f(0) = g(0) = 0$). Then

$$\lim_{x \rightarrow 0} \frac{f(x)}{g(x)} = \lim_{x \rightarrow 0} \frac{\frac{f(x) - f(0)}{x - 0}}{\frac{g(x) - g(0)}{x - 0}},$$

and since the limits $\lim_{x \rightarrow 0} \frac{f(x) - f(0)}{x - 0}$ and $\lim_{x \rightarrow 0} \frac{g(x) - g(0)}{x - 0}$ exist and are equal to $f'(0)$ and $g'(0) \neq 0$ respectively, we have

$$\lim_{x \rightarrow 0} \frac{f(x)}{g(x)} = \lim_{x \rightarrow 0} \frac{\frac{f(x) - f(0)}{x - 0}}{\frac{g(x) - g(0)}{x - 0}} = \frac{\lim_{x \rightarrow 0} \frac{f(x) - f(0)}{x - 0}}{\lim_{x \rightarrow 0} \frac{g(x) - g(0)}{x - 0}} = \frac{f'(0)}{g'(0)}.$$

8. We cannot. The function $f(x) = 2 - x^2 \left(2 + \sin \frac{1}{x} \right)$, for instance, has a maximum at the point $x = 0$, for $x \neq 0$ and $f(0) = 2$ but its derivative $f'(x)$ does not retain sign in any sufficiently small neighbourhood of the point $x = 0$. 9. (a) $a \in (0; 1) \cup (1; 4)$. \blacktriangle The given function is differentiable throughout the number axis and, therefore, only those points at which $f'(x) = 0$ can be its critical points. Let us find $f'(x)$:

$$f'(x) = \frac{1}{2}(a-1)(a-2) \left(-\sin \frac{x}{2} \right) + (a-1).$$

It is evident that if $a = 1$, then $f'(x) = 0$ for any $x \in \mathbb{R}$, i.e. every point $x \in \mathbb{R}$ is critical. Let us consider the equation $f'(x) = 0$ or $(a-2) \sin \frac{x}{2} = 2$, $a \neq 1$. This equation has no solutions if $|2/(a-2)| > 1$ and $a \neq 1$, i.e. if $a \in (0; 1) \cup (1; 4)$, and this means that $f'(x) \neq 0$ for these values of a and the function has no critical points; (b) $a \in [2; 4) \cup (4; \infty)$. \bullet Show that the given function has no critical points for the values of a for which the equation $1/\cos^2 x = (a-3)/(a-2)$, $a \neq 4$, has no solutions; (c) $a \in (-\infty; -4/3) \cup [2; \infty)$. 10. $\{-6\pi; -9\pi/2; 0\}$. 11. $\{\cos 1 \cos 3; \sin 1 \sin 3\}$, it increases. \blacktriangle We note, first of all, that the parameter a must satisfy the inequality $\ln(2a - a^2) \geq 0$. But

$$\ln(2a - a^2) \geq 0 \iff 2a - a^2 \geq 1 \iff a = 1.$$

Thus, $a = 1$; then

$$\begin{aligned} f(x) &= 4x^3 - 6x^2 \cos 2 + 3x \sin 2 \sin 6, \\ f'(x) &= 12x^2 - 12x \cos 2 + 3 \sin 2 \sin 6. \end{aligned}$$

Solving the quadratic equation $4x^2 - 4x \cos 2 + \sin 2 \sin 6 = 0$, we find the critical points: $x_1 = \cos 1 \cos 3$, $x_2 = \sin 1 \sin 3$. To decide whether the function f increases or decreases for $x = 0.5$, we must determine the sign of the number $f'(0.5)$. We have $f'(0.5) = 3(1 + \sin 2 \cdot \sin 6) - 6 \cos 2 > 0$ since the expression in the parentheses

is positive and $\cos 2 < 0$. **12.** It decreases. **13.** $[-4; (3 - \sqrt{21})/2] \cup (1; \infty)$. **14.** $[-7; -1] \cup [2; 3]$. **15.** $2\frac{1}{4}$. ● Prove that the given function has a period 2π and find its largest and least values on the interval $[0; 2\pi]$. **16.** $M(e^{-4/3}; -\sqrt{2e^{-4/3}})$. ● Find the least value of the function $l^2(x) = x^2 \left(1 + \frac{9}{2}(\ln x + 1)^2\right)$ on the half-interval $[e^{-1.5}; \infty)$ (l being the length of the segment of the tangent to the given curve intercepted between the point M and the y -axis). **17.** $M_1(1; e^{-1}), M_2(-1; e^{-1})$. ● Find the coordinates of the point M_1 ($x \geq 0$) and use the fact that the function $y = e^{-|x|}$ is even. **18.** $1/\sqrt{5}$. ● Show that the equation $x^4 + 3x^2 + 2x = 2x - 1$ has no roots. Derive the equation of the tangent to the given curve parallel to the straight line $y = 2x - 1$. **19.** $(-\infty; 0] \cup \left\{\frac{1}{2e}\right\}$. ● Show that for $a > 0$ the curves $y_1 = ax^2$ and $y_2 = \ln x$ can have only one point in common if they touch each other (at the point of tangency $y'_1(x) = y'_2(x)$ in that case) and for $a \leq 0$ these curves are sure to intersect at only one point x_0 (consider the behaviour of these functions on the intervals $(0; x_0)$ and $(x_0, 1)$).

9.4. Integral Calculus. Miscellaneous Problems

1. No, we cannot. For instance, $f(x) = 1 + \cos x$ is a periodic function and $F(x) = \int (1 + \cos x) dx = x + \sin x + c$ is a nonperiodic function. **2.** (a) ▲ By the definition, $F'(x) = f(x)$. But $f(x)$ is an odd

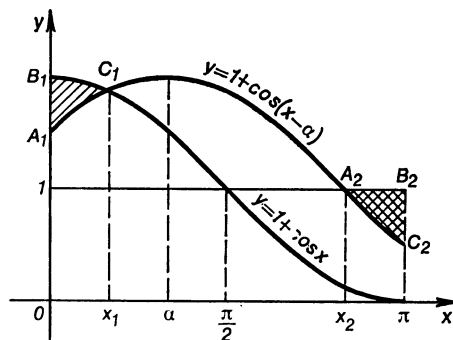

function. Consequently, $F(x)$ is an even function (see problem 3 in 9.3); (b) ● Use the assertion made in (a); (c) 0. ● Prove that the function $f(x) = x^6 (\arcsin x)^7$ is odd on the interval $[-1, 1]$. **3.** The antiderivative $F(x)$ is odd if $F(0) = 0$. **4.** $f(x) \geq 0$ if $a < b$; $f(x) \leq 0$ if $a > b$ (for all $x \in [a; b]$). **5.** $\{\pi/3\}$. ▲ Suppose $S_{A_1B_1C_1}$ is the area of the figure bounded by the lines $y = 1 + \cos x, y = 1 + \cos(x - \alpha), x = 0$, and $S_{A_2B_2C_2}$ is the area of the figure bounded by the lines

$y = 1$, $y = 1 + \cos(x - \alpha)$ and $x = \pi$. Then we have

$$S_{A_1B_1C_1} = \int_0^{x_1} [(1 + \cos x) - (1 + \cos(x - \alpha))] dx$$

and

$$S_{A_2B_2C_2} = \int_{x_2}^{\pi} [1 - (1 + \cos(x - \alpha))] dx.$$

Let us find the limits of integration x_1 and x_2 : from the equation $1 + \cos x = 1 + \cos(x - \alpha)$ we find $x_1 = \alpha/2$, and from the equation $1 = 1 + \cos(x - \alpha)$ we find $x_2 = \alpha + \pi/2$. Calculating now the integrals, we find

$$S_{A_1B_1C_1} = 2 \sin(\alpha/2) - \sin \alpha \quad \text{and} \quad S_{A_2B_2C_2} = 1 - \sin \alpha.$$

The figures $A_1B_1C_1$ and $A_2B_2C_2$ being equal, we have $2 \sin(\alpha/2) - \sin \alpha = 1 - \sin \alpha$ or $\sin(\alpha/2) = 1/2$. Solving the equation $\sin(\alpha/2) = 1/2$ and taking into account the restriction $0 < \alpha < \pi/2$, we get the answer. 6. $[\log_2 3; \infty)$. 7. (a) $\{e^{-1}\}$. ● $f'(x) = 1 + \ln^2 x + 2 \ln x$;

$$(b) \left\{ \frac{\pi}{6}; \frac{\pi n}{2} \pm \frac{\pi}{6} \mid n \in N \right\}. \quad 8. -2 \times \sqrt{3} + 3/2 + 1/\sqrt{2}.$$

▲ Differentiating $F(x)$, we obtain $F'(x) = 3 \sin x + 4 \cos x$. $F'(x) < 0$ on the interval $(5\pi/4; 4\pi/3)$ since $\sin x$ and $\cos x$ assume only negative values (x belongs to the third quarter) and, therefore, $F(x)$ attains the least value at the point $x = 4\pi/3$. Calculating the

integral $\int_{5\pi/4}^{4\pi/3} (3 \sin t + 4 \cos t) dt$, we get the answer. 9. $3\sqrt{3} -$

$-2\sqrt{2} - 1$. 10. $F(x) = 3^x + x - 4; \{1\}$. 11. ▲ If $f_1(x) \equiv f_2(x)$ on some set D , and f_1 and f_2 are differentiable at all points of the domain D , then $f_1'(x) \equiv f_2'(x)$. We have $(\sin 2x)' = (2 \sin x \cos x)'$, or $2 \cos 2x = 2(\cos^2 x - \sin^2 x)$, or $\cos 2x = \cos^2 x - \sin^2 x$.

12. $(1; (1 + \sqrt{5})/2)$. ● Find the roots of the equation $f(x) = \varphi(x)$ on the intervals $(-\infty; -1)$, $[-1; 0)$ and $[0; \infty)$. 13. $-(\tan \varphi)/6$.

▲ The equation of the straight line cutting the given parabola has the form $y = (\tan \varphi)x + b$, where b is some constant. From the condition that the straight line cuts the parabola at two points follows the consistency of the system of equations

$$\begin{cases} y = 1 - 3x^2, \\ y = x \tan \varphi + b. \end{cases}$$

Eliminating y from this system, we arrive at a quadratic equation $x^2 + \frac{1}{3}(\tan \varphi)x - \frac{1}{3} + \frac{b}{3} = 0$, whose roots x_1 and x_2 are the abscissas of the intersection points of the straight line and the parabola. The midpoint of the segment connecting the points of

intersection can be found by the formula $x_0 = \frac{x_1 + x_2}{2}$, and since $x_1 + x_2 = -(\tan \varphi)/3$ (the Vieta theorem), we have $x_0 = -(\tan \varphi)/6$.
14. $\{2\pi n - \pi/2 | n \in \mathbb{Z}\}$. **15.** $a \in (9\pi/8; 11\pi/8]$. **16.** $[7\pi/6; 5\pi/4)$.
17. $\{2\pi n + \pi/4; (2n+1)\pi - \arctan 2 | n \in \mathbb{Z}\}$. **▲** Suppose $(\sin \alpha) x^2 + (2 \cos \alpha) x + \frac{\cos \alpha + \sin \alpha}{2} = (kx + b)^2$ for any $x \in \mathbb{R}$. Then the following equalities must hold simultaneously:

$$\begin{cases} k^2 = \sin \alpha, \sin \alpha > 0, \\ 2kb = 2 \cos \alpha, \\ b^2 = \frac{\cos \alpha + \sin \alpha}{2} > 0. \end{cases}$$

Multiplying the first and the third equality term-by-term and squaring the second equality, we get

$$k^2 b^2 = \sin \alpha \frac{\cos \alpha + \sin \alpha}{2}, \quad k^2 b^2 = \cos^2 \alpha.$$

Let us eliminate $k^2 b^2$ in these relations. Then we have $\sin^2 \alpha + \sin \alpha \cos \alpha - 2 \cos^2 \alpha = 0$ or (since the last equation is homogeneous) $\tan^2 \alpha + \tan \alpha - 2 = 0$. Now we have

$$\tan \alpha_1 = 1, \quad \tan \alpha_2 = -2;$$

$$\alpha_1 = \pi m + \frac{\pi}{4}, \quad \alpha_2 = \pi m - \arctan 2, \quad m \in \mathbb{Z}.$$

For the inequalities $\sin \alpha > 0$ and $\frac{\cos \alpha + \sin \alpha}{2} > 0$ to hold true,

we must take $m = 2n$ in the first series of solutions and $m = 2n + 1$ in the second series. Finally we find that for $\alpha = 2\pi n + \pi/4$ or $\alpha = (2n + 1)\pi - \arctan 2$ the given quadratic function is the square of a linear function. **18.** $(-\infty; -14) \cup \{4\} \cup [14/3; \infty)$. **●** Since the original equation is equivalent to the system

$$\begin{cases} bx + 28 = 12 - 4x - x^2, & (1) \\ 12 - 4x - x^2 = -(x+6)(x-2) > 0, & (2) \end{cases}$$

the given equation can have a unique solution if: (1) the roots x_1 and x_2 of equation (1) are equal and satisfy inequality (2); (2) provided the roots of equation (1) are different ($x_2 > x_1$) and at least one of the following systems is consistent:

$$\begin{cases} x_1 < -6, \\ -6 < x_2 < 2 \end{cases} \quad \text{or} \quad \begin{cases} x_2 > 2, \\ -6 < x_1 < 2; \end{cases}$$

(3) for $x_1 = -6$ and $-6 < x_2 < +2$ or $x_2 = 2$ and $-6 < x_1 < 2$. **19.** $[5/2; \infty)$. **▲** The solution of the inequality

$$\frac{\log_3(x^2 - 3x + 7)}{\log_3(3x + 2)} < 1$$

is the union of the intervals $x \in (-2/3; -1/3) \cup (1; 5)$. For every solution of the inequality to be a solution of the inequality $x^2 + (5 - 2a)x \leq 10a$, the zeros x_1 and x_2 of the function $f(x) = x^2 + (5 - 2a)x - 10a$ must satisfy the inequalities $x_1 \leq -2/3$ and $x_2 \geq 5$, i.e. the inequalities $f(-2/3) \leq 0$ and $f(5) \leq 0$ must hold simultaneously. We shall get the answer solving the system of inequalities

$$\begin{cases} (-2/3)^2 + (5 - 2a)(-2/3) - 10a \leq 0, \\ 5^2 + (5 - 2a)5 - 10a \leq 0. \end{cases}$$

20. No they are not in the general case. ● Consider the example: $1/x > x$ for all $x \in (0; 1)$, but the inequality $(1/x)' > x'$ does not hold on this interval. 21. (a) $\{(\tan a; 2; \ln(2a - 1))\}$ for $a \in (1/2; \pi/2)$, for $a \notin (1/2; \pi/2)$; (b) $\{(1; e^a; \pi n + (-1)^n \arcsin(a + 1) \mid n \in \mathbb{Z})\}$ for $a \in [-2, 0]$, \emptyset for $a \notin [-2, 0]$. 22. The solution is given in the figure. ● Represent the left-hand side of the equation in the form $(x + ay + b)(x^2 + cxy + dy^2)$ and, having determined the coefficients a, b, c, d , reduce it to the form $(x - y + 1)(x^2 + 4xy + 5y^2) = 0$. 23. $A = 7, B = -6, C = 3$. ▲ We find the relationship between the coefficients

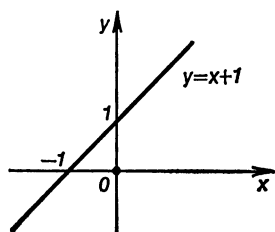

A, B, C . From the hypothesis we have: $f'(x) = 2Ax + B, f'(1) = 2A + B = 8, f(2) + f''(2) = A \cdot 2^2 + B \cdot 2 + C + 2A = 33,$

$\int_0^1 (Ax^2 + Bx + C) dx = \frac{A}{3} + \frac{B}{2} + C = \frac{7}{3}$. We shall get the answer when we solve the system of equations

$$\begin{cases} 2A + B = 8, \\ 6A + 2B + C = 33, \\ A/3 + B/2 + C = 7/3. \end{cases}$$

24. $K = 3, L = 1, M = 5$. 25. $P = 5; Q = -6, R = 3$; 26. $(0; 2)$. ▲ In the system of coordinates xOy we find the set of points satisfying all the inequalities of the system (the hatched figure in the given figure). We put $z = 2x + 3y, z = 0$ in the equation and construct the

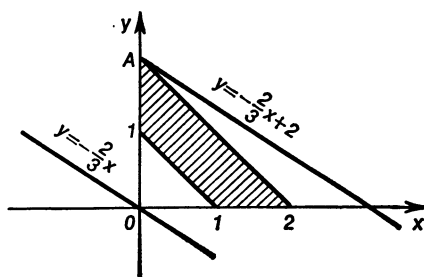

straight line $y = -2x/3$. For any value of c , the line $2x + 3y = c$ is parallel to the line $2x + 3y = 0$ and, with an increase in c , it will be displaced upwards. The greatest value of c , for which this line has points in common with the domain of solutions of the given system, is the value for which this line passes through the point A with the coordinates $x = 0, y = 2$ (for $c = 6$). 27. $-73/8$. For $x = -9/4, y = 5/4$.

$$\begin{aligned} \triangle 2x + x^2 + 2xy + 3y^2 - 3y - 5 &= (x^2 + 2x(y+1) + (y+1)^2) \\ - (y+1)^2 + 3y^2 - 3y - 5 &= (x+y+1)^2 + 2\left(y^2 - 2\frac{5}{4}y + \frac{25}{16}\right) \\ -\frac{25}{8} - 6 &= (x+y+1)^2 + 2\left(y - \frac{5}{4}\right)^2 - \frac{73}{8}. \end{aligned}$$

Hence it follows that the least value is equal to $-73/8$ and is attained at $x + y + 1 = 0, y - 5/4 = 0$, i.e. $x = -9/4, y = 5/4$. 28. The solution is given in the figure. ● Calculate the respective limits for $0 < x < 1, x = 1$ and $x > 1$. 29. 4950π . ● Prove that the roots of the equation form an arithmetic progression and that the equation has 100 roots on the interval $[0; 314]$. 30. $S_1(x) = \frac{x^{2n+2} - 1}{x^2 - 1}$

or $|x| \neq 1, S_1 = n+1$ for $|x| = 1;$
 $S_2(x) = \frac{2x(n x^{2n+1} - (n+1)x^{2n} + 1)}{(x^2 - 1)^2}$
for $|x| \neq 1, S_2 = n(n+1)$ for $x = 1;$
 $S_2 = -n(n+1)$ for $x = -1$

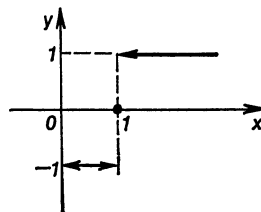

● To find the sum $S_1(x)$, use the formula for the sum of the first n terms of a geometric progression, and to find $S_2(x)$, use the equality $S_1'(x) = S_2(x)$. 31. 26. ▲ We find the coordinates of the vectors \vec{OA} and \vec{OB} . Since $y_1 = x_1^2 - 2x_1 + 3$, we have $y_1 = 2$ and the vector $\vec{OA} = (1 - 0; 2 - 0) = (1; 2)$. We determine the abscissa of the point B :

$$x_2^2 - 2x_2 + 3 = y_2 = 11, \quad x_2^2 - 2x_2 - 8 = 0; \quad x_2 = 4 \quad \text{or} \quad x_2 = -2.$$

And since the point B lies in the first quarter, it has the coordinates $x = 4, y = 11$ and, therefore, $\vec{OB} = (4; 11)$. Next we find $\vec{OA} \cdot \vec{OB} = 1 \cdot 4 + 2 \cdot 11 = 26$. 32. 3. 33. $(-4/3; 0]$. ▲ Since $\mathbf{p} \cdot \mathbf{q} = |\mathbf{p}| \cdot |\mathbf{q}| \times \cos(\widehat{\mathbf{p}\mathbf{q}})$ and $|\mathbf{p}| > 0, |\mathbf{q}| > 0$, the angle between the vectors \mathbf{p}

and \mathbf{q} is obtuse if $\cos(\widehat{\mathbf{p}\mathbf{q}}) < 0$ or $\mathbf{p} \cdot \mathbf{q} < 0$. We have $\mathbf{p} \cdot \mathbf{q} = c \log_2^2 x + 6c \log_2 x - 12$. Setting $\log_2 x = t$, we arrive at the following problem: at what values of c does the inequality $ct^2 + 6ct - 12 < 0$ hold for any $t \in \mathbb{R}$? Evidently, for $c = 0$ the inequality $-12 < 0$ is true for any $t \in \mathbb{R}$. If $c \neq 0$, then for these conditions to be fulfilled, the following inequalities must be satisfied simultaneously:

$$\begin{cases} c < 0, \\ (6c)^2 + 48c < 0. \end{cases}$$

Solving this system of inequalities, we get $c \in (-4/3; 0)$; adding $c = 0$ to these values, we get the answer. 34. $\{\pi(4n+1) - \arctan 2; \pi(4n+2) - \arctan 2 \mid n \in \mathbb{Z}\}$. \blacktriangle From the hypothesis, we have a system

$$\begin{cases} \tan^2 \alpha - \tan \alpha - 6 = 0, \\ \sin 2\alpha < 0, \\ \sin(\alpha/2) > 0. \end{cases}$$

Solving the equation of the system for $\tan \alpha$, we get $\tan \alpha = 3$ and $\tan \alpha = -2$. For $\tan \alpha = 3$ the inequality $\sin 2\alpha < 0$ is not satisfied. Therefore, $\alpha = \pi k - \arctan 2$. We seek the integral values of k for which the inequality $\sin \frac{\alpha}{2} > 0$ is satisfied. We introduce the designation $\arctan 2 = 2\beta$:

$$\sin\left(\frac{\pi k}{2} - \beta\right) = \sin \frac{\pi k}{2} \cos \beta - \cos \frac{\pi k}{2} \sin \beta > 0.$$

Suppose $k = 2l$, $l \in \mathbb{Z}$. Then $\cos \pi l \sin \beta = (-1)^{l+1} \sin \beta > 0$ if $l = 2n + 1$, $n \in \mathbb{Z}$. If $k = 2l + 1$, $l \in \mathbb{Z}$, then $\sin\left(\pi + \frac{\pi}{2}\right) \cos \beta =$

$= (-1)^l \cos \beta > 0$ for $l = 2n$, $n \in \mathbb{Z}$. Thus, the inequality $\sin \frac{\alpha}{2} > 0$ is satisfied if $\alpha = \pi(2(2n+1)) - \arctan 2$ or $\alpha = (2 \cdot 2n + 1)\pi - \arctan 2$. 35. $x - 2y + 11 = 0$, $2x + y - 8 = 0$. \blacktriangle Suppose $K(x_0, y_0)$ is a point of the circle through which the tangent to the circle $(x+1)^2 + y^2 = 20$ with centre at the point $O(-1; 0)$ passes.

The vectors $\vec{AK} = (x_0 - 1, y_0 - 6)$ and $\vec{OK} = (x_0 + 1, y_0)$ are mutually perpendicular and, therefore $\vec{AK} \cdot \vec{OK} = 0$ or $(x_0 - 1) \times (x_0 + 1) + (y_0 - 6)y_0 = 0$. We have a system of equations

$$\begin{cases} x_0^2 + y_0^2 - 6y_0 - 1 = 0, \\ x_0^2 + y_0^2 + 2x_0 - 19 = 0. \end{cases}$$

Subtracting the second equation from the first, we get $x_0 = 9 - 3y_0$. Substituting this value of x_0 into the first equation, we get an equation $y_0^2 - 6y_0 + 8 = 0$, whose roots are $y_{01} = 4$, $y_{02} = 2$. Thus, the points on the circle through which the tangents pass have the coordinates $K_1(-3; 4)$ and $K_2(3; 2)$. We get the answer using the formula

$$\frac{x - x_A}{x_K - x_A} = \frac{y - y_A}{y_K - y_A}.$$